

**FLUKE®**

USER'S HANDBOOK

**Model 9500B**

**High Performance Oscilloscope Calibrator**

*Operation and Performance*

*Final Width = 215mm*

# User's Handbook

For

## The Model 9500B

### High Performance Oscilloscope Calibrator

*Operation and Performance*

Final Width = 215mm

© 2003 Fluke Precision Measurement Ltd.

Part No. 1625019 Issue 7.0 (December 2003)

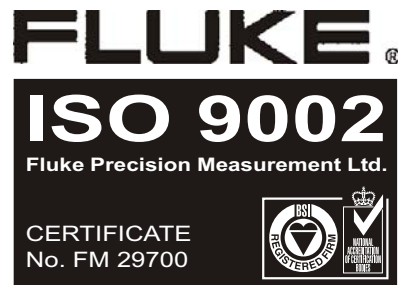

For any assistance contact your nearest Fluke Sales and Service Center.  
Addresses can be found at the back of this handbook.

Due to our policy of continuously updating our products, this handbook may contain minor differences in specification, components and circuit design to the instrument actually supplied. Amendment sheets precisely matched to your instrument serial number are available on request.

## LIMITED WARRANTY AND LIMITATION OF LIABILITY

Each Fluke product is warranted to be free from defects in material and workmanship under normal use and service. The warranty period is one year and begins on the date of shipment. Parts, product repairs, and services are warranted for 90 days. This warranty extends only to the original buyer or end-user customer of a Fluke authorized reseller, and does not apply to fuses, disposable batteries, or to any product which, in Fluke's opinion, has been misused, altered, neglected, contaminated, or damaged by accident or abnormal conditions of operation or handling. Fluke warrants that software will operate substantially in accordance with its functional specifications for 90 days and that it has been properly recorded on non-defective media. Fluke does not warrant that software will be error free or operate without interruption.

Fluke authorized resellers shall extend this warranty on new and unused products to end-user customers only but have no authority to extend a greater or different warranty on behalf of Fluke. Warranty support is available only if product is purchased through a Fluke authorized sales outlet or Buyer has paid the applicable international price. Fluke reserves the right to invoice Buyer for importation costs of repair/replacement parts when product purchased in one country is submitted for repair in another country.

Fluke's warranty obligation is limited, at Fluke's option, to refund of the purchase price, free of charge repair, or replacement of a defective product which is returned to a Fluke authorized service center within the warranty period.

To obtain warranty service, contact your nearest Fluke authorized service center to obtain return authorization information, then send the product to that service center, with a description of the difficulty, postage and insurance prepaid (FOB Destination). Fluke assumes no risk for damage in transit. Following warranty repair, the product will be returned to Buyer, transportation prepaid (FOB Destination). If Fluke determines that failure was caused by neglect, misuse, contamination, alteration, accident, or abnormal condition of operation or handling, including overvoltage failures caused by use outside the product's specified rating, or normal wear and tear of mechanical components, Fluke will provide an estimate of repair costs and obtain authorization before commencing the work. Following repair, the product will be returned to the Buyer transportation prepaid and the Buyer will be billed for the repair and return transportation charges (FOB Shipping Point).

THIS WARRANTY IS BUYER'S SOLE AND EXCLUSIVE REMEDY AND IS IN LIEU OF ALL OTHER WARRANTIES, EXPRESS OR IMPLIED, INCLUDING BUT NOT LIMITED TO ANY IMPLIED WARRANTY OF MERCHANTABILITY OR FITNESS FOR A PARTICULAR PURPOSE. FLUKE SHALL NOT BE LIABLE FOR ANY SPECIAL, INDIRECT, INCIDENTAL, OR CONSEQUENTIAL DAMAGES OR LOSSES, INCLUDING LOSS OF DATA, ARISING FROM ANY CAUSE OR THEORY.

Since some countries or states do not allow limitation of the term of an implied warranty, or exclusion or limitation of incidental or consequential damages, the limitations and exclusions of this warranty may not apply to every buyer. If any provision of this Warranty is held invalid or unenforceable by a court or other decision-maker of competent jurisdiction, such holding will not affect the validity or enforceability of any other provision.

*Final Width = 215mm*

Sept 1, 2001

*Fluke reserves the right to amend specifications without notice.*

---

# Contents

Page

**SAFETY ISSUES: READ THIS ENTIRE SECTION THOROUGHLY BEFORE ATTEMPTING TO  
INSTALL, OPERATE OR SERVICE THE MODEL 9500B** 0-8

## Section 1 The Model 9500B High Performance Oscilloscope Calibrator

1.1	About Section 1 .....	1-1
1.2	Introduction to the Model 9500B .....	1-2
1.3	Model 9500B Associated Products and Options .....	1-4

## Section 2 Installing the Model 9500B

2.1	About Section 2 .....	2-1
2.2	Lifting and Carrying the Model 9500B .....	2-1
2.3	Unpacking and Inspection .....	2-2
2.4	Storage .....	2-2
2.5	Preparation for Shipment .....	2-2
2.6	Calibration Enable Switch .....	2-2
2.7	Preparation for Operation .....	2-3
2.8	Connectors and Pin Designations .....	2-7
2.9	Care of Microwave Connectors .....	2-9

## Section 3 Model 9500B Controls

3.1	About Section 3 .....	3-1
3.2	Introduction to the Front Panel .....	3-2
3.3	Preferences .....	3-6
3.4	Modes of Operation .....	3-8

## Section 4 Using the Model 9500B — Manual Mode

4.1	About Section 4 .....	4.1-1
4.2	Interconnections .....	4.2-1
4.3	Manual Mode — Function Selection .....	4.3-1
4.4	Edit Facilities .....	4.4-1
<b>Functions:</b>		
4.5	DC/Square Function .....	4.5-1
4.6	Levelled Sine Function .....	4.6-1
4.7	Edge Function .....	4.7-1
4.8	Time Markers Function .....	4.8-1
4.9	Auxiliary Functions .....	4.9-1
4.10	Current Function .....	4.10-1
4.11	Composite Video Function .....	4.11-1
4.12	Linear Ramp Function .....	4.12-1
4.13	Overload Pulse Function .....	4.13-1
4.14	Zero Skew Function .....	4.14-1
4.15	Auxiliary Input Function .....	4.15-1
4.16	Load Resistance and Capacitance Measurement Function .....	4.16-1
4.17	Input Leakage Function .....	4.17-1
4.18	Pulse Width Function .....	4.18-1

Final Width = 215mm

	Page
<b>Section 5 Using the Model 9500B — Procedure Mode</b>	
5.1 About Section 5 .....	5-1-1
5.2 Procedure Mode — Safety and General Notes .....	5-2-1
5.3 Procedure Mode — Access Guide .....	5-3-1
<b>Section 6 9500B System Application via IEEE-488 Interface</b>	
6.1 About Section 6 and Section 6 Contents .....	6-1-1
6.2 Index of IEEE-488.2 and SCPI Codes used in the Model 9500B .....	6-2-1
6.3 Introduction .....	6-3-1
6.4 Using the 9500B in a System .....	6-4-1
6.5 Retrieval of Device Status Information .....	6-5-1
6.6 9500B SCPI Language - Commands and Syntax .....	6-6-1
Section 6 Appendix A: IEEE 488.2 Device Documentation Requirements .....	6-A1
Section 6 Appendix C: IEEE 488.2 Common Commands and Queries Implemented in the Model 9500B .....	6-C1
Section 6 Appendix D: Model 9500B — Device Settings after *RST & Power On .....	6-D1
Section 6 Appendix F: Model 9500B — Emulation of Tektronix SG5030 and CG5010/5011 .....	6-F1
<b>Section 7 Model 9500B Specifications</b>	
7.1 General .....	7-1
7.2 Accuracy Specifications .....	7-1
7.3 Voltage Function Specifications .....	7-2
7.4 Edge Function Specifications .....	7-3
7.5 Time Markers Function Specifications .....	7-4
7.6 Levelled Sine Function Specifications .....	7-5
7.7 Dual Sine Function Specifications .....	7-6
7.8 Pulse Width Function Specifications .....	7-7
7.9 Other Output Function Specifications .....	7-8
7.10 Trigger Output Specifications .....	7-10
<b>Section 8 Model 9500B — Routine Maintenance and Test</b>	
8.1 About Section 8 .....	8-1
8.2 Routine Maintenance .....	8-2
8.3 Model 9500B Test and Selftest .....	8-4
8.4 Printing Selftest Results .....	8-10
Section 8 Appendix A: Error Reporting Subsystem .....	8-A1

Final Width = 215mm

**Section 9 Verifying the Model 9500B Specification**

9.1	About Section 9 .....	9-1
9.2	Need for Verification .....	9-1
9.2.1	Factory Calibration and Traceability .....	9-1
9.2.2	Verification on Receipt from the Factory .....	9-1
9.2.3	Verification after User-Calibration .....	9-1
9.3	Equipment Requirements .....	9-1
9.4	Interconnections .....	9-1
9.5	Verification Points .....	9-1
9.6	Specification Limits .....	9-2
9.7	Verification Procedure .....	9-2
9.8	9500B Mainframe Verification by Functions	
9.8.1	Verifying the DC/Square Function: DC Voltage .....	9-2
9.8.2	Verifying the DC/Square Function: Square Voltage .....	9-6
9.8.3	Verifying the LF Sine Voltage Function .....	9-10
9.8.4	Verifying the Time Markers Function .....	9-13
9.8.5	Verifying the Load Resistance Measurement Function .....	9-15
9.8.6	Verifying the Pulse Width Function .....	9-18
9.9	9510/9530/9550/9560 Head Verification by Functions	
9.9.1	Verifying the Levelled Sine Voltage Function: LF Gain .....	9-20
9.9.2	Verifying the Levelled Sine Voltage Function: Flatness .....	9-23
9.9.3	Verifying the Edge Function .....	9-29
9.9.4	Verifying the Load Capacitance Measurement Function .....	9-33

Final Width = 215mm

**Section 10 Calibrating the Model 9500B**

10.1	About Section 10 and Section 10 Contents .....	10.1-1
10.2	9500B Mainframe Calibration and Active Head™ Calibration .....	10.2-1
10.2.1	Introduction .....	10.2-1
10.2.2	Mainframe Unit Calibration .....	10.2-1
10.2.3	Active Head Calibration .....	10.2-1
10.2.4	Other Functions .....	10.2-1
10.2.5	Mainframe Unit Manual Calibration .....	10.2-1
10.3	The Model 9500B Calibration Mode .....	10.3-1
10.3.1	Introduction .....	10.3-1
10.3.2	Mode Selection .....	10.3-2
10.3.3	Selection of Calibration Mode .....	10.3-2
10.3.4	Special Calibration .....	10.3-3
10.3.5	Special Cal: 'Adjust FREQ' .....	10.3-4
10.3.6	Mainframe Standard Calibration (STD CAL) .....	10.3-5
10.3.7	Overview of Calibration Operations .....	10.3-6
10.4	Standard Calibration — Basic Sequences .....	10.4-1
10.4.1	Introduction .....	10.4-2
10.4.2	Target Selection Screen — Selecting Hardware Configurations .....	10.4-2
10.4.3	The Adjustment Screen .....	10.4-3
10.4.4	Calibrating the Model 9500B at Target Values .....	10.4-4
10.4.5	Standard Calibration of AC Functions .....	10.4-5
10.4.6	Exit from Calibration - Cal Date and Cal Due Date .....	10.4-6

**Section 10 Calibrating the Model 9500B - Cont.**

- 10.5 Front Panel Calibration by Functions ..... 10.5-1
  - 10.5.1 Introduction ..... 10.5-1
  - 10.5.2 Summary of Calibration Process ..... 10.5-2
  - 10.5.3 DC/Square — DC Voltage Calibration ..... 10.5-4
  - 10.5.4 DC/Square — Square Calibration ..... 10.5-8
  - 10.5.5 LF Sine Voltage Calibration ..... 10.5-13
  - 10.5.6 Load Resistance Measurement Calibration ..... 10.5-16
- 10.6 9510/9530/9550/9560 Head Calibration Procedures ..... 10.6-1
  - 10.6 Introduction ..... 10.6-1
  - 10.6.1 Levelled Sine Function: LF Gain ..... 10.6-1
  - 10.6.2 Levelled Sine Function: HF Calibration ..... 10.6-3
  - 10.6.3 Edge Function Calibration ..... 10.6-7
  - 10.6.4 Calibrating the Timing Markers ..... 10.6-13
  - 10.6.5 Load Capacitance Calibration ..... 10.6-14
  - 10.6.6 50 /1M Ratio Calibration ..... 10.6-15
  - 10.6.7 Exit from Head Calibration ..... 10.6-16

**Fluke's Regional Sales & Service Centers**

Inside Rear Cover

Final Width = 215mm

# SAFETY ISSUES

READ THIS ENTIRE SECTION THOROUGHLY BEFORE ATTEMPTING TO INSTALL, OPERATE OR SERVICE THE MODEL 9500B

## General Safety Summary

This instrument has been designed and tested in accordance with the British and European standard publication EN61010:1993/A2:1995, and has been supplied in a safe condition.

This manual contains information and warnings that must be observed to keep the instrument in a safe condition and ensure safe operation. Operation or service in conditions or in a manner other than specified could compromise safety. For the correct and safe use of this instrument, operating and service personnel must follow generally accepted safety procedures, in addition to the safety precautions specified.

To avoid injury or fire hazard, **do not** switch on the instrument if it is damaged or suspected to be faulty. **Do not** use the instrument in damp, wet, condensing, dusty, or explosive gas environments.

Whenever it is likely that safety protection has been impaired, make the instrument inoperative and secure it against any unintended operation. Inform qualified maintenance or repair personnel. Safety protection is likely to be impaired if, for example, the instrument shows visible damage, or fails to operate normally.

**WARNING THIS INSTRUMENT CAN DELIVER A LETHAL ELECTRIC SHOCK. NEVER TOUCH ANY LEAD OR TERMINAL UNLESS YOU ARE ABSOLUTELY CERTAIN THAT NO DANGEROUS VOLTAGE IS PRESENT.**



## Explanation of safety related symbols and terms



**DANGER** **electric shock risk**  
The product is marked with this symbol to indicate that hazardous voltages (>30 VDC or AC peak) may be present.



**CAUTION** **refer to documentation**  
The product is marked with this symbol when the user must refer to the instruction manual.

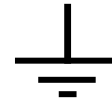

**Earth (Ground) terminal**  
Functional Earth (Ground) only - must not be used as a Protective Earth.

**WARNING** **WARNING STATEMENTS IDENTIFY CONDITIONS OR PRACTICES THAT COULD RESULT IN INJURY OR DEATH.**

**CAUTION** **CAUTION STATEMENTS IDENTIFY CONDITIONS OR PRACTICES THAT COULD RESULT IN DAMAGE TO THIS OR OTHER PROPERTY.**

*Final Width = 215mm*



---

## Protective Earth (Ground)

### Protection Class I:

The instrument **must** be operated with a Protective Earth/Ground connected via the power cable's protective earth/ground conductor. The Protective Earth/Ground connects to the instrument before the line & neutral connections when the supply plug is inserted into the power socket on the back of the instrument.

**WARNING** ANY INTERRUPTION OF THE PROTECTIVE GROUND CONDUCTOR INSIDE OR OUTSIDE THE INSTRUMENT IS LIKELY TO MAKE THE INSTRUMENT DANGEROUS.



To avoid electric shock hazard, make signal connections to the instrument after making the protective ground connection. Remove signal connections before removing the protective ground connection, i.e. **the power cable must be connected whenever signal leads are connected.**

### Do Not Operate Without Covers

To avoid electric shock or fire hazard, **do not** operate the instrument with its covers removed. The covers protect users from live parts, and unless otherwise stated, must only be removed by qualified service personnel for maintenance and repair purposes.

**WARNING** REMOVING THE COVERS MAY EXPOSE VOLTAGES IN EXCESS OF 1.5KV PEAK (MORE UNDER FAULT CONDITIONS).



### Safe Operating Conditions

Only operate the instrument within the manufacturer's specified operating conditions. Specification examples that must be considered include:

- ambient temperature
- ambient humidity
- power supply voltage & frequency
- maximum terminal voltages or currents
- altitude
- ambient pollution level
- exposure to shock and vibration

To avoid electric shock or fire hazard, **do not** apply to or subject the instrument to any condition that is outside specified range. See Section 6 of this manual for detailed instrument specifications and operating conditions.

**CAUTION** CONSIDER DIRECT SUNLIGHT, RADIATORS AND OTHER HEAT SOURCES WHEN ASSESSING AMBIENT TEMPERATURE.



**CAUTION** BEFORE CONNECTING THE INSTRUMENT TO THE SUPPLY, MAKE SURE THAT THE REAR PANEL AC SUPPLY VOLTAGE CONNECTOR IS SET TO THE CORRECT VOLTAGE AND THAT THE CORRECT FUSES ARE FITTED.



*Final Width = 215mm*

*continued overleaf*

---

## The Power Cable and Power Supply Installation Category I: Disconnection

The intended power supply disconnect device is the ON/OFF switch that is located on the instrument's rear panel. The ON/OFF switch **must** be readily accessible while the instrument is operating. If this operating condition cannot be met, the power cable plug or other power disconnecting device **must** be readily accessible to the operator.

To avoid electric shock and fire hazard, make sure that the power cable is not damaged, and that it is adequately rated against power supply network fusing. If the power cable plug is to be the accessible disconnect device, the power cable must not be longer than 3 metres.

### Power Input & Fuse Requirements

To avoid fire hazard, use only the fuse arrangements that appear in the fuse specification table below. Additionally, the supply network must be fused at a maximum of 16A, and in the UK, a 10A fuse must be fitted in the power cable plug See Section 2.7 for details of setting line input voltage and changing the line input fuse.

Measurement and/or guard terminals are designed for connection at Installation (Overvoltage) Category I. To avoid electric shock or fire hazard, the instrument terminals must not be directly connected to the AC line power supply, or to any other voltage or current source that may (even temporarily) exceed the instrument's peak ratings.

**WARNING TO AVOID INJURY OR DEATH, DO NOT CONNECT OR DISCONNECT SIGNAL LEADS WHILE THEY ARE CONNECTED TO A HAZARDOUS VOLTAGE OR CURRENT SOURCE. MAKE SURE THAT ALL LEADS ARE IN A SAFE CONDITION BEFORE YOU HANDLE THEM IN ANY WAY.**



Make sure that the instrument is correctly protectively earthed (safety grounded) via the power cable before and while any other connection is made.

*Final Width = 215mm*

**Power Input Fuse**

Supply (Line) Voltage Selection	Fuse Action	Fuse Rating (IEC)	Fluke Part No.	Manufacturer & Type No.
115 VAC	TH	10A	920274	Littlefuse 215010.
230 VAC	TH	5A	920273	Littlefuse 215005.

---

## Maintenance and Repair

Observe all applicable local and/or national safety regulations and rules while performing any work. First disconnect the instrument from all signal sources, then from the AC line supply before removing any cover. Any adjustment, parts replacement, maintenance or repair should be carried out only by the manufacturer's authorised technical personnel.

**WARNING** FOR PROTECTION AGAINST INJURY AND FIRE HAZARD, USE ONLY MANUFACTURER SUPPLIED PARTS THAT ARE RELEVANT TO SAFETY. PERFORM SAFETY TESTS AFTER REPLACING ANY PART THAT IS RELEVANT TO SAFETY.



## Moving and Cleaning

First disconnect the instrument from all signal sources, then from the AC line supply before moving or cleaning. See Section 8.2 for Routine Maintenance procedures.

*Final Width = 215mm*

**Observe any additional safety instructions or warnings given in this manual.**

BLANK PAGE (LEFT-HAND)  
*Final Width = 215mm*

## Section 1 The Model 9500B High Performance Oscilloscope Calibrator



Fig. 1.1 General View of Model 9500B with an Active Head

Final Width = 215mm

### 1.1 About Section 1

Section 1 introduces the Model 9500B High Performance Oscilloscope Calibrator. It is divided into the following sub-sections:

	Page
1.2 Introducing the Model 9500B	
1.2.1 Variants	1.1
1.2.1 Functions	1.2
1.2.2 Operating Modes	1-3
1.2.2.1 Manual Mode	1-3
1.2.2.2 Procedure Mode	1-3
1.2.2.3 Configuration Mode	1-3
1.2.2.4 Calibration Mode	1-3
1.2.2.5 Test Mode	1-4
1.2.3 System Operation	1-4
1.2.3.1 Remote Interface	1-4
1.2.3.2 Portocal II	1-4
1.3 Model 9500B Associated Products and Options	1-4

### 1.2 Introduction to the Model 9500B

#### 1.2.1 Functions

The Model 9500B is a state-of-the-art calibrator offering oscilloscope test and calibration capabilities from a single source, providing wide functionality. (Variant 9500B/1100 is described—for other variants, refer to their specifications in Section 7.) The functions listed overleaf are not necessarily available via every model of Active Head.

Final Width = 215mm

## 1.2.1 Functions (Contd.)

- **DC Function:**
  - Output Voltage:** (into 50Ω):  $\pm(888\mu\text{V to } 5.56\text{V})$
  - Output Voltage:** (into 1MΩ):  $\pm(888\mu\text{V to } 222.4\text{V})$
- **Square Function:**
  - Frequencies:** 10Hz to 100kHz
  - Output Voltage:** (pk-pk into 50Ω): 35.52μV to 5.56V
  - Output Voltage:** (pk-pk into 1MΩ Load): 35.52μV to 222.4V
- **Sine Function** *(Variant 9500B/1100 quoted below); (see Sect. 7 for specifications of other variants):*
  - Frequencies:** 100mHz to 550MHz
  - Output Voltage:** (pk-pk into 50Ω & 1MΩ): 4.44mV to 5.56V
  - Frequencies:** 550MHz to 1.1GHz
  - Output Voltage:** (pk-pk into 50Ω & 1M): 4.44mV to 3.35V
- **Dual Channel**
- **Edge Function:** Selectable Rising/Falling Edge
  - Low Edge:** 500ps: Active Head Model 9510 or 9530
  - Periods:** 500ns to 100ms
  - Output Voltage:** (pk-pk into 50Ω & 1MΩ): 4.44mV to 3.1V
  - High Edge:** 100ns: Active Head Model 9510 or 9530
  - Periods:** 10μs to 100ms
  - Output Voltage:** (pk-pk into 50Ω): 888mV to 5.56V
  - (pk-pk into 1MΩ): 888mV to 222.4V
  - Fast Edge:** 150ps: Active Head Model or 9530
  - Periods:** 500ns to 100ms
  - Output Voltage:** (pk-pk into 50Ω & 1MΩ): 4.44mV to 3.1V
- **Time Markers Function** (Output Voltage pk-pk into 50Ω & 1M) *(Variant 9500B/1100 quoted below); (see Sect. 7 for specifications of other variants):*
  - Square/Sine Waveforms**
  - Squarewave Periods:** 9.0091ns to 55s (111MHz to 18.181mHz)
  - (Highlighted style):** 20ns to 55s (50MHz to 18.181mHz)
  - Output Voltage:** 100mV to 1.0V
  - Sinewave Periods:** 450.5ps to 9.009ns (2.22GHz to 111MHz)
  - Output Voltage:** 100mV to 500mV
  - Sinewave Periods:** 909.1ps to 9.009ns (1.1GHz to 111MHz)
  - Output Voltage:** 1.0V
  - Pulse and Triangle Waveforms:**
  - Periods:** 900.91ns to 55s (1.11MHz to 18.181mHz)
  - (Highlighted style):** 20ns to 55s (50MHz to 18.181mHz)
  - Output Voltage:** 100mV to 1.0V
- **Pulse Width Function:**
  - Amplitude:** 1Vpk-pk into 50W
  - Pulse Width:** 1ns to 100ns
  - Rise/Fall Time:** <500ps
  - Frequency:** 1kHz to 1MHz
- **Current Function:**
  - DC:**
  - Output Current:**  $\pm(88.8\mu\text{A to } 111.2\text{mA})$
  - Square:**
  - Frequencies:** 10Hz to 100kHz
  - Output Current:** 88.8μA pk-pk to 111.2mA pk-pk
- **Composite Video Function:**
  - Polarity:** Positive and Negative sync
  - Patterns:** Full Raster Selectable: White, Mid Grey or Black.
  - Amplitude Levels p-p:** White: 1V, mid-grey: 0.7V, black: 0.3V. No deviation.
  - Frame Standards:** 625 lines/50Hz, 525 lines/60Hz
  - Trigger:** Calibrator trigger output selectable to Odd Field Start, or Composite Sync.
- **Linear Ramp Function:**
  - Period:** 3s, 300ms, 30ms, 3ms.
  - Ramps:** Equal Rise, Fall and Flat divisions per cycle.
  - Amplitude:** 1V pk-pk
  - Bias:** Symmetrical about ground
  - Trigger Alignment:** Start of rising or falling ramp
- **Overload Pulse Function:**
  - Pulse Amplitude:** 5.0V to 20.0V (0.1V resolution)
  - Pulse Energy:** 1.6J to 50.0J (0.1J resolution)
  - Polarity:** Positive or negative from ground
  - Pulse Duration:** at 20V: 200ms to 6.25s; at 5V: 3.2s to 100s (Internally calculated from Amplitude and Energy)
  - Power into 50Ω:** 0.5W to 8W (Internally calculated from Amplitude)
  - Repetition Rate:** Single manually-triggered event, max repetition rate 0.3Hz.
  - UUT Scope Trigger:** With energy pulse, or Auto trigger at 100Hz
- **Zero Skew Function:**
  - Frequencies:** 10Hz to 100MHz.
  - Default Alignment:** 9500B output channel skew = ≤50ps.
  - Align 9500B Channel Output Timing:** Using a single oscilloscope channel.
  - Measure UUT Scope Channel Skew:** Using aligned 9500B channels.
- **Auxiliary Input:**
  - Signal Path:** Automated, passive, relay-switched routing of user's external calibration waveforms to any Active Head's BNC connector via the output multiplexer.
  - Impedance:** Input and Output: 50Ω.
  - 3dB Bandwidth:** Approx. 400MHz.
  - Trigger:** No trigger pickoff provided, internal trigger not available.
- **Load Resistance and Capacitance Measurement:**
  - Resistance Range:**
  - Input:** 10kΩ to 20MΩ.
  - Termination:** 10Ω to 150Ω.
  - Capacitance:**
  - Range:** 1pF to 120pF.
- **Reference Frequency Input:**
  - Frequency Range:** 1MHz to 20MHz in 1MHz integer steps.
  - Amplitude Range:** 70mV pk-pk to 1V pk-pk.
- **Reference Frequency Output:**
  - Frequency Range:** 1MHz or 10MHz.
  - Level into 50Ω:** >1.15V.
  - Level into 1MΩ:** >2.3V.
- **Input Leakage Function:**
  - Short/Open Circuit Outputs:** Allows testing of UUT oscilloscope input leakage current.
  - UUT Scope Trigger:** Auto trigger at 100Hz

---

## 1.2.2 Operating Modes

In order to be able to calibrate a wide range of different oscilloscope parameters, flexibility is built into the design of the 9500B. Of the five major modes only two: 'Manual' and 'Procedure', determine the everyday front-panel use of the instrument. The other three are concerned with system configuration, 9500B calibration and 9500B selftest.

### 1.2.2.1 Manual Mode

In 'Manual' Mode: the 9500B is operated entirely from the front panel. The operator is in complete charge of the calibration procedure, usually interpreted locally from the UUT oscilloscope manufacturer's calibration data. Refer to *Sections 3 and 4*.

### 1.2.2.2 Procedure Mode

'Procedure' Mode involves the use of a memorized calibration procedure. The manufacturer's data for the UUT oscilloscope will have been interpreted into a series of calibration operations, which are programmed on to a memory card. When the card is inserted into the 'PROCEDURE' slot in the front panel, the 9500B will move from operation to operation, switching the 9500B controls automatically, and issuing a series of requests for the operator to change UUT switching and connections. Refer to *Section 5*.

Portocal II v 1.7 (see paras 1.3) can be used to generate calibration sequences on procedure cards to calibrate UUT oscilloscopes using the Model 9500B.

### 1.2.2.3 Configuration Mode

This mode, requiring a password, provides access for the user-selectable configuration options. These include:

- Set the internal reference frequency.
- Adjust the threshold for high voltage warning.
- Change the IEEE-488 bus addresses.
- Select or deselect remote emulation (SG5030 or CG5010/5011).
- Enable or disable use of an external printer (Procedure mode only).
- Set the instrument to power-up in either Manual or Procedure mode.
- Alter the passwords required for entry to Configuration and Calibration modes.
- Select the frequency for External Reference Input.
- Set the frequency of, or disable, External Reference Output.
- Alter the memorized date and time, and its format of presentation.
- Set User language (for Procedure mode only).
- Determine the percentage of UUT measurement tolerance beyond which a 'Borderline' result is called (in Procedure mode only).

- Enable or disable the use of a data card for 'RESULTS' (Procedure mode only).
- Enable or disable fields in certificates to accommodate Engineer's note (Procedure mode only).
- Select the type of certificate required to be printed, alter some of the certificate details, and re-format its pages (Procedure mode only).
- Clear the displayed list of Procedure mode users.

### 1.2.2.4 Calibration Mode

Calibration of the 9500B itself cannot proceed until two security measures have been satisfied:

1. The rear panel 'CAL' switch must be set to its 'ENABLE' position.  
*Note: The switch is recessed behind a small hole — at shipment this hole is covered by a paper seal which should not be broken except for an authorized recalibration.  
A broken seal is regarded as invalidating the previous calibration.*
2. An acceptable password must be entered on the screen.

Once into Calibration mode, there are three types of calibration available. These should be used only under supervision — if it is suspected that calibration may be required, contact your Fluke Service Center.

- '**Special**' calibration, enabling automatic calibration of the main A-D converter.
- '**Factory use only**' is an initial calibration which is not available to users, requiring a second password.
- '**Standard Calibration**' will initiate manual calibration procedures for those functions requiring recalibration.

Calibration of the 9500B is detailed in *Section 9: 'Specification Verification'* and *Section 10: 'Calibration' (Adjustment)*. Those 9500B calibration sequences which are user-accessible are detailed in *Section 10*. If it is suspected that some other calibration may be required, contact your Fluke Service Center.

*Final Width = 215mm*

*Test Mode overleaf→*

## 1.3 Model 9500B Associated Products and Options

### 1. Active Head™

At least one unit of the following products is *necessary* to complete the output connection from the 9500B output channel to one channel of the UUT oscilloscope.

Model 9510	1.1GHz Output Module (Active Head™) with 500ps pulse edge capability.
Model 9530	3.2GHz Output Module (Active Head™) with 150ps and 500ps pulse edge capabilities.
Model 9550	25ps Fast Edge Output Module (Active Head™) with 25ps pulse edge capability only.
Model 9560	6.4GHz Output Module (Active Head™) with 70ps pulse edge capability. Requires 9500-3200 or 9500B-3200 base with issue 3.0 firmware or greater.

Check the last section of this manual for an Addendum that describes any additional Active Head models.

Any one of the fitted heads can be used to provide triggers for the UUT oscilloscope instead of signals. However, a Trigger Cable (SMC-to-BNC) is shipped with the 9500B to provide triggers to a separate trigger input on the UUT oscilloscope, with a mix of up to four active heads.

2. The following accessories are shipped with the instrument:

Pt. No.	Description
401297	Current Loop Assembly <i>for use in Current Function.</i>
630477	Trigger Cable <i>for trigger purposes only, in place of an Active Head™.</i>

3. The available options for the 9500B are as follows:

Option 60	Carry Case.
Option 90	Rack Mounting Kit.

Line Voltage: The 9500B is configured for use at the correct voltage at the shipment point. The 9500B can be reconfigured for a different line voltage, requiring a different power fuse (*Refer to Section 2, paras 2.7.4 and 2.7.5.*)

### 1.2.2.5 Test Mode

Three main variants of self test are available for user initiation:

- **'Base'** Test: Tests the base unit only. No head data is tested.
- **'Heads'** Test: Tests the fitted Active Heads only, assuming that base tests have been passed.
- **'All'** Test: Tests both the base unit and active heads fitted.

**Note:** In the above three tests, the 9500B will keep a list of all test failures, including the number of the test and its result. Any failures can then be recalled using screen keys.

- **'Fast'** Test: This is the same as the confidence test carried out at power-on, checking power supplies, basic operation, etc.
- **'Interface'** Test: This can be used to check the operation of the display and its memory, the keyboard and/or printer connected to the instrument. A blank memory card inserted in either slot on the front panel can also be tested (*WARNING!: the stored contents of any memory card subjected to this test will be overwritten!*).

It is possible to print out a set of results of selftests. A printer can be connected directly to the 25-way Centronics™ printer port on the rear panel. The printer can be enabled from within Configuration mode.

Test procedures and error-code descriptions are given in *Section 8*. In the case of a reported or suspected failure, consult your Fluke Service Center.

### 1.2.3 System Operation

#### 1.2.3.1 Remote Interface

The instrument can form part of an automated system by means of the IEEE-488 standard digital interface. The interface has been included both for automatic calibration of UUT oscilloscopes, and for automatic calibration of the 9500B itself. The method of connecting to the system controller and the IEEE-488.2 SCPI command codes are described in *Section 6*.

Emulation of the SG5030 and CG5010/5011 is available only via the remote IEEE-488 interface, as detailed in *Section 6, Appendix F*.

#### 1.2.4.2 Met/Cal II

The 9500B is included in the number of calibrators accessible through Met/Cal II which can be used to calibrate UUT oscilloscopes remotely.

*Final Width = 215mm*



---

## Section 2 Installing the Model 9500B

### 2.1 About Section 2

Section 2 contains information and instructions for unpacking and installing the Model 9500B Universal Calibration System. It is divided into the following sub-sections:

	page
2.2 Lifting and Carrying the Model 9500B	
2.2.1 Lifting and Carrying from Bench Height .....	2-1
2.2.2 Lifting and Putting Down at Low Level .....	2-1
2.3 Unpacking and Inspection .....	2-2
2.4 Storage .....	2-2
2.5 Preparation for Shipment .....	2-2
2.6 Calibration Enable Switch .....	2-2
2.7 Preparation for Operation .....	2-3
2.7.1 Mounting .....	2-4
2.7.1.1 Bench Mounting .....	2-4
2.7.1.2 Rack Mounting .....	2-4
2.7.2 Power Input .....	2-6
2.7.3 Power Cable .....	2-6
2.7.4 Power Fuse .....	2-6
2.7.5 Line Voltage .....	2-7
2.8 Connectors and Pin Designations	
2.8.1 IEEE-488 Input/Output Socket .....	2-7
2.8.2 Parallel Port .....	2-8
2.8.3 Serial Port .....	2-8
2.8.4 Auxiliary Input .....	2-9
2.8.5 Ref Frequency Input .....	2-9
2.8.6 Ref Frequency Output .....	2-9
2.9 Care of Microwave Connectors .....	2-9

### 2.2 Lifting and Carrying the 9500B

**Caution!** *The 9500B weighs in excess of 12kg, so take special care when lifting and carrying the instrument.*

#### 2.2.1 Lifting and Carrying from Bench Height

1. Disconnect and remove any cables from the rear panel.
2. The 9500B center of gravity is concentrated at the rear. Tilt the unit so that it is standing vertically on its rear panel, with the feet towards you, at the edge of the bench.
3. Grasp the instrument at the bottom (rear panel) corner furthest away from you, and tilt it slightly to rest against you. Take the weight and carry it vertically at the same height, making sure that it remains resting against you.
4. Place the 9500B down at the same level by setting it vertically on to the surface, then swivel it so that it can be tilted back on to its feet.

#### 2.2.2 Lifting and Putting Down at Low Level

1. Always bend your knees, not your back, when going down. Keep your back as straight and as vertical as possible.
2. Use the same technique (2.2.1 - 3 above) to hold the instrument's center of gravity close to you.

---

## 2.3 Unpacking and Inspection

Every care is taken in the choice of packing materials to ensure that your equipment will reach you in perfect condition.

If the equipment has been subject to excessive mishandling in transit, the fact will probably be visible as external damage to the shipping container and inner carton. In the event of damage, the shipping container, inner carton and cushioning material should be kept for the carrier's inspection.

Carefully unpack the equipment and check for external damage to the case, sockets, controls, etc. If the shipping container and cushioning material are undamaged, they should be retained for use in subsequent shipments. If damage is found notify the carrier and your sales representative immediately.

Standard accessories (associated products and options) supplied with the instrument should be as described in Section 1 and on your delivery note.

## 2.4 Storage

The instrument should be stored under cover. The shipping container provides the most suitable receptacle for storage, as it provides the necessary shock isolation for normal handling operations.

Place the instrument with an active desiccant sachet inside a sealed bag. Fit the bag into the cushioning material inside the inner carton, place this within the corner cushioning blocks inside the outer shipping container, and locate the whole package within the specified storage environment.

## 2.5 Preparation for Shipment

If the 9500B is to be transported, please consider using the carry case, Option 60.

The instrument should be transported under cover. The original (double) shipping container should be used to provide shock isolation for normal handling operations. Any other container should be double-cushioned, providing similar shock isolation to the following approximate internal packing dimensions:

	Length	Width	Depth
<b>Outer Box</b>	785mm	675mm	440mm
<b>Inner Box</b>	675mm	565mm	315mm
<b>Cushioned to</b>	460mm	430mm	145mm

Place the instrument with an active desiccant sachet inside a sealed bag. Fit the bag into the cushioning material inside the inner carton, place this within the corner cushioning blocks inside the outer shipping container, and secure the whole package.

## 2.6 Calibration Enable Switch

### IMPORTANT

This two-position, 'CAL' switch on the rear panel protects the instrument calibration memory. The instrument was initially calibrated at the factory, so under no circumstances should the switch be operated, until immediate recalibration is intended.

### For Recalibration:

If Calibration Mode is entered while the switch is in the 'DISABLE' position, the following warning message is placed on the screen:

**Calibration switch not enabled!**

## 2.7 Preparation for Operation

### IMPORTANT:

Refer to the Safety Issues section at the front of this manual, together with additional information in the Model 9500B General Specifications, including Environmental Conditions: *Section 7, sub-section 7.1.*

Before preparing the Model 9500B calibrator for operation, note the danger warning:



**DANGER**



**THIS INSTRUMENT IS CAPABLE OF DELIVERING AN ELECTRIC SHOCK. UNDER NO CIRCUMSTANCES TOUCH ANY INSTRUMENT TERMINAL UNLESS YOU ARE FIRST SATISFIED THAT NO DANGEROUS VOLTAGE IS PRESENT.**

Other than the main output active head connectors, the connections to the 9500B are via the rear panel:

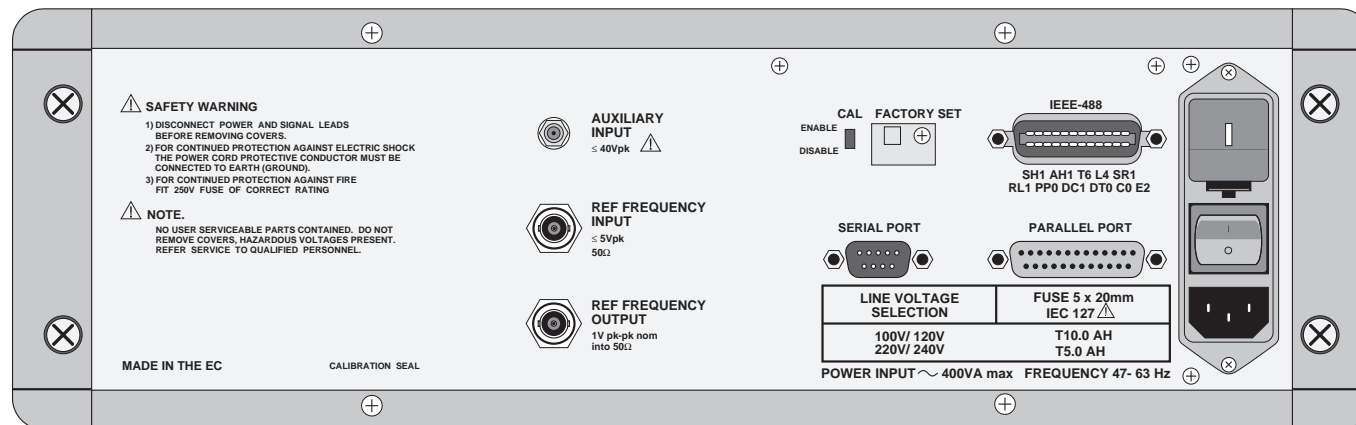

**9500B Rear Panel**

2.7.1 Mounting: *overleaf*→

---

## 2.7 Preparation for Operation *(Contd.)*

### 2.7.1 Mounting

#### 2.7.1.1 Bench Mounting

The instrument is fitted with four plastic feet and a tilt stand. It can stand flat on a bench, positioned so that the cooling-air inlet on the right side and exhaust apertures on the left side are not obstructed.

#### 2.7.1.2 Option 90 — Rack Mounting *(Fig. 2.1)*

Option 90 permits the instrument to be mounted in a standard 19 inch rack. The method of fitting this option is described below, the locations being shown in *Fig. 2.1*.

##### A. Provision of Option 90

1. Option 90 is provided with all necessary attachments and fixings.
2. The 9500B is fitted with side extrusions with holes to accommodate rack mounting fixing screws.

##### B. Fitting the Mountings to the 9500B

1. Fit left and right front rack mounting ears (these are interchangeable) to the 9500B:
  - a. Assemble the handles to the front ears as shown in the diagram, and secure using the four M4 x 12 POZICSK screws provided.
  - b. Secure the front ears through the side extrusions to the chassis, with the brackets at the front as shown. Use two M5 x 20 POZIPAN screws, plain and shakeproof washers provided, through the lower holes of each ear.
2. Fit left and right rear rack sliders (these are interchangeable) to the 9500B:

Secure both sliders through the side extrusions to the chassis, at the rear as shown. Use the four M5 x 20 POZICSK screws provided..

##### C. Removing the 9500B Feet and Tilt Stand *(if required)*

Remove the feet and tilt stand:

- a. Prize off the rubber pads from the four feet.
- b. Undo the two securing screws from each foot. This releases the feet, washers and tilt stand so that they can be detached and stored safely for possible future use.

##### D. Fitting the Rear Ears to the Rack

Fit the left and right rear ears (*not* interchangeable) to the rack:

- a. Fit the eight M6 cage nuts into the correct cutouts at front and rear of the rack (*see Fig. 2.1*). Squeeze the cage on each nut and insert from the inside of the rack.
- b. Offer up each appropriate ear to the outside of the back of the rack, with the tongue facing forward as shown in the diagram. Secure the ears using four of the eight M6 x 16 chromium-plated POZIPAN screws and four M6 washers.

##### E. Fitting the 9500B into the Rack

With assistance, slide the instrument into the rack, locating the rear ears in the sliders on the side extrusions. Push the instrument home, and secure the front ears to the rack using the other four M6 x 16 chromium-plated POZIPAN screws and four M6 washers.

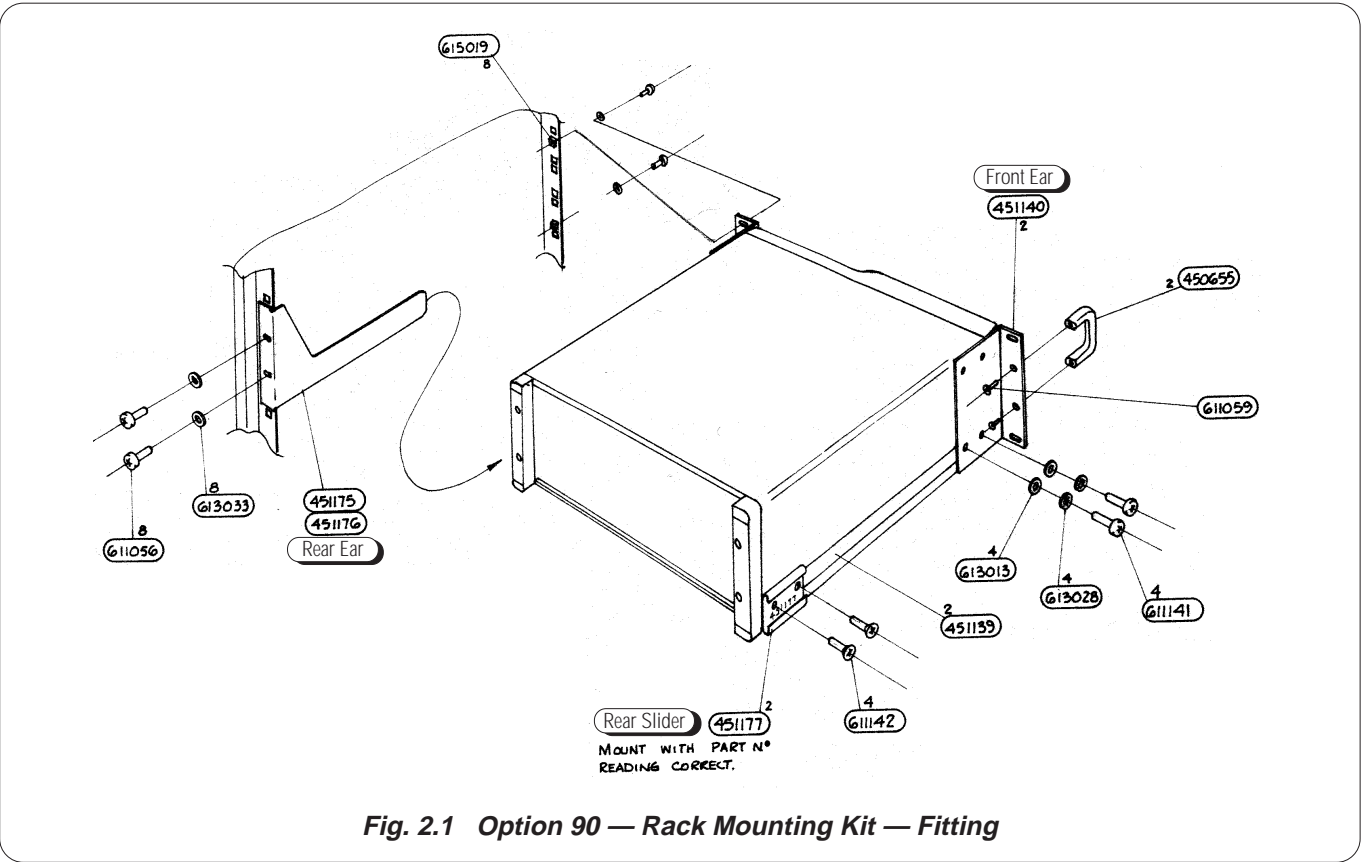

## 2.7 Preparation for Operation (Contd.)

### 2.7.2 Power Input

The recessed **POWER INPUT** plug, **POWER FUSE**, **POWER SWITCH** and **LINE VOLTAGE SELECTOR** are contained in an integral filtered module on the right of the rear panel (looking from behind the unit).



LINE VOLTAGE SELECTION	FUSE 5 x 20mm IEC 127
100V/ 120V	T10.0 AH
220V/ 240V	T5.0 AH

POWER INPUT ~ 400VA max FREQUENCY 47- 63 Hz



A window in the fuse drawer allows the line voltage selection to be inspected. To inspect the fuse rating the fuse drawer must be taken out (Refer to sub-section 2.7.4. **First switch off and remove the power cable**).

### 2.7.3 Power Cable

The detachable supply cable, comprising two meters of 3-core PVC sheath cable permanently moulded to a fully-shrouded 3-pin socket, fits in the **POWER INPUT** plug recess.



The supply lead **must** be connected to a grounded outlet ensuring that the ground lead is connected.

SEE THE SAFETY ISSUES SECTION AT THE FRONT OF THIS MANUAL.

### 2.7.4 Power Fuse

The fuse rating is:

T 5.0A HBC, 250V, IEC127 for 220/240V line supply.

T 10.0A HBC, 250V, IEC127 for 100/120V line supply.

It is fitted into the reverse side of the Fuse Drawer, in the Power Input module on the rear panel, and **must** be of **High Breaking Capacity**.

#### WARNING



**MAKE SURE THAT ONLY FUSES WITH THE REQUIRED RATED CURRENT AND OF THE SPECIFIED TYPE ARE USED FOR REPLACEMENT. SEE THE SAFETY ISSUES SECTION AT THE FRONT OF THIS MANUAL.**

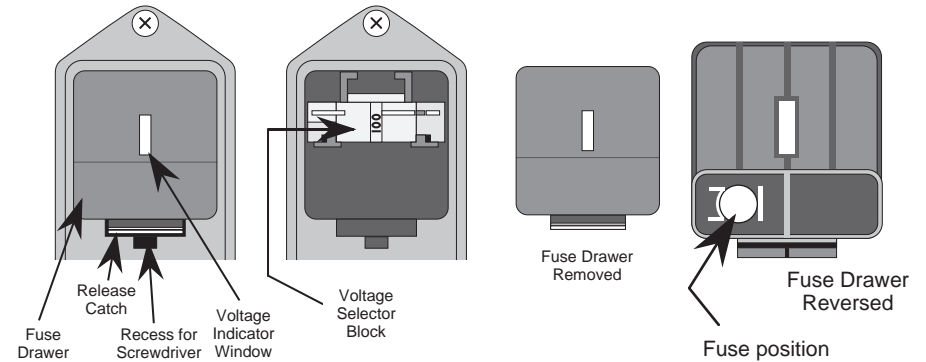

#### 2.7.4.1 Power Fuse Replacement

When the power fuse is to be replaced, proceed as follows:

1. **Ensure that the POWER CABLE is removed.** Insert a small screwdriver blade in the narrow recess beneath the catch under the fuse drawer; lever gently downwards until the catch releases. Pull the drawer out, and reverse it to see the fuse.
2. Check the fuse and replace if required.
3. Check that the desired voltage is visible at the front of the voltage selector block inside the power module cavity.
4. Insert the fuse drawer into the module and press until the catch is heard to click into place.

## 2.7.5 Line Voltage

The 9500B is operative for line voltages in the ranges: 100/120/220/240V, 48-63Hz.

To accommodate these ranges, a small voltage selector block is housed behind the **POWER FUSE** drawer.

### 2.7.5.1 Selection of Operating Line Voltage



**Ensure that the POWER CABLE is removed.**

1. Insert a small screwdriver blade in the narrow recess beneath the catch under the fuse drawer; lever gently downwards until the catch releases. Pull the drawer out to reveal the grey voltage selector block.
2. Hook a small finger into the block in the square recess in its base; pull to disengage its contacts, and remove from the module cavity.
3. Rotate the voltage selector board until the desired voltage faces outward.
4. Ensure that the block is upright. Re-insert the block firmly into its cavity in the module.
5. Check the fuse if required (*see paras 2.7.4*), then insert the fuse drawer into the module and press until the catch is heard to click into place.
6. Check that the desired voltage is visible in the cutout in the fuse drawer.

## 2.8 Connectors and Pin Designations

### 2.8.1 IEEE-488 Input/Output (Rear Panel)

This 24-way input/output connector on the rear panel, which is labelled IEEE-488, is directly compatible with the IEEE-488 and IEC-625 Interface Bus standards.

#### Pin Layout

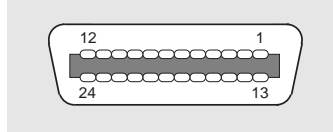

#### Pin Designations

Pin No.	Name	Description
1	DIO 1	Data Input Output Line 1
2	DIO 2	Data Input Output Line 2
3	DIO 3	Data Input Output Line 3
4	DIO 4	Data Input Output Line 4
5	EOI	End or Identify
6	DAV	Data Valid
7	NRFD	Not ready for Data
8	NDAC	Not Data Accepted
9	IFC	Interface Clear
10	SRQ	Service Request
11	ATN	Attention
12	SHIELD	Screening on cable (connected to Safety Ground)
13	DIO 5	Data Input Output Line 5
14	DIO 6	Data Input Output Line 6
15	DIO 7	Data Input Output Line 7
16	DIO 8	Data Input Output Line 8
17	REN	Remote Enable
18	GND 6	Ground wire of twisted pair with DAV
19	GND 7	Ground wire of twisted pair with NRFD
20	GND 8	Ground wire of twisted pair with NDAC
21	GND 9	Ground wire of twisted pair with IFC
22	GND 10	Ground wire of twisted pair with SRQ
23	GND 11	Ground wire of twisted pair with ATN
24	0V_F	Logic Ground (Internally associated with Safety Ground)

*Continued overleaf*→

## 2.8 Connectors and Pin Designations *(Contd.)*

### 2.8.2 Parallel Port (Rear Panel)

This 25 way D-Type socket is located beneath the IEEE-488 connector on the rear panel. Its connections are similar to the 25-way printer port on PCs, carrying control and data for an external printer as designated in the table.

#### Pin Layout

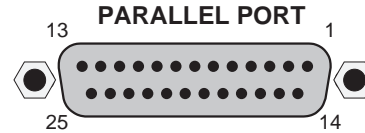

#### Pin Designations

9500B Pin No.	9500B Signal Name	9500B I/O	Description or Common Meaning
1	STROBE_L	Output	1 $\mu$ s pulse to cause printer to read one byte of data from data bus DO1 — DO8.
2	DO1	Output	Data bit 1
3	DO2	Output	Data bit 2
4	DO3	Output	Data bit 3
5	DO4	Output	Data bit 4
6	DO5	Output	Data bit 5
7	DO6	Output	Data bit 6
8	DO7	Output	Data bit 7
9	DO8	Output	Data bit 8
10	ACKNLG_L	Input	Pulse to indicate that the printer has accepted a data byte, and is ready for more data.
11	BUSY_H	Input	Printer is temporarily busy and cannot receive data.
12	P_END_H	Input	Printer is out of paper.
13	SLCT_H	Input	Printer is in on-line state, or connected.
14	AUTO_FEED_L	Output	Paper is automatically fed 1 line after printing. This line is fixed _H (high) by the 9500B to disable auto feed.
15	ERROR_L	Input	Printer is in 'Paper End', 'Off-line' or 'Error' state.
16	INIT_L	Output	Commands printer to reset to power-up state, and in most printers to clear its print buffer.
17	SLCT_IN_L	Output	Commands some printers to accept data. This line is fixed _L (low) by the 9500B.
18-25	OV_F	Output	Digital Common

\_H  $\equiv$  Logic-1 active; \_L  $\equiv$  Logic-0 active.

### 2.8.3 Serial Port (Rear Panel)

This 9-way D-Type socket is located to the left of the Parallel port connector on the rear panel. Its connections are RS232-compatible; carrying control and power supplies for, and receiving data from, an external tracker ball.

#### Pin Layout

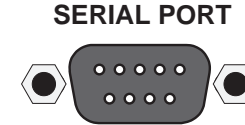

#### Pin Designations

Pin No.	Name	Description
1	---	Not used
2	RXD0_L	Serial Data: Tracker Ball $\rightarrow$ 9500B
3	TXD0_L	Serial Data: 9500B $\rightarrow$ Tracker Ball
4	DTR0_H	Data Terminal Ready
5	OV_F	Digital Common
6	DSR0_H	Data Set Ready
7	RTS0_H	Request to Send
8	CTS0_H	Clear to Send
9	---	Not used

\_H  $\equiv$  Logic-1 active; \_L  $\equiv$  Logic-0 active.



## 2.8.4 Auxiliary Input (Rear Panel)



This SMC connector is located at the upper center of the rear panel, providing an internal, passive, relay switched route for a user's external calibration signal, via any one of five output channels to an Active Head's BNC or PC3.5 connector .

Internal controls are provided (via front-panel keys or via the IEEE-488 / SCPI interface) to switch the signal between channels. For further details see *Section 4, para 4.15.5* and *Section 6, para 6.6.5.17*.

## 2.8.5 Ref Frequency Input (Rear Panel)



This BNC connector is located at the middle center of the rear panel, providing an input for a signal of good frequency accuracy, for use as a frequency reference in the 9500B.

Internal controls are provided (via front-panel keys in Configuration mode) to select the signal as reference. For further details see *Section 3, para 3.4.3.10*.

## 2.8.6 Ref Frequency Output (Rear Panel)



This BNC connector is located at the lower center of the rear panel, providing an output reference signal of the same frequency accuracy as the 9500B.

Internal controls are provided (via front-panel keys in Configuration mode) to select the signal as reference. For further details see *Section 3, para 3.4.3.11*.

## 2.9 Care of Microwave Connectors

It is necessary to observe certain basic precautions when using microwave connectors, in order to achieve accurate and repeatable calibration and measurement results. This will also help to extend connector life.

Good practice includes:

- When not in use, ensure that connectors are kept clean. This is best done by using a plastic endcap. Avoid touching components whose function is to make electrical contact.
- Visually inspect all connectors, looking for dents, scratches and metal particles. **Never** use damaged connectors.
- Clean connectors properly, particularly connector threads and dielectric faces. Try compressed air first, and if this is insufficient, use isopropyl alcohol. Avoid spillage, and **never** use abrasives.
- When making connections, be careful to align connectors carefully, avoiding bending forces. Always make the initial connection lightly to avoid cross-threading, and use a correctly-set torque wrench for final tightening.

BLANK PAGE (LEFT-HAND)

## Section 3 Model 9500B Controls

### 3.1 About Section 3

#### 3.1.1 Introduction

Section 3 is a detailed description of the 9500B operating controls; starting with a general description of the front panel. The user preferences 'Pref' key and screen is described, followed by a brief description of Mode selection.

#### 3.1.2 Section Contents

Section 3 is divided into the following sub-sections:

	page		page
3.1 About Section 3		3.4 Modes of Operation	
3.2 Introduction to the Front Panel		3.4.1 Mode Selection	3-8
3.2.1 Local and Remote Operation	3-2	3.4.1.1 Mode Overview	3-8
3.2.1.1 Remote, Semi-Automatic and Manual Calibration of UUT Oscilloscopes	3-2	3.4.2 Passwords and Access	3-9
3.2.1.2 Use of Procedure Memory Cards	3-2	3.4.3 Configuration Mode	3-9
3.2.1.3 Manual and Remote Calibration of the 9500B Itself	3-2	3.4.3.1 'MORE' Configuration	3-9
3.2.1.4 General Arrangement of Front Panel Controls	3-2	3.4.3.2 'Ref Frequency'	3-10
3.2.2 Front Panel Features	3-3	3.4.3.3 'Safety voltage'	3-10
3.2.2.1 Liquid Crystal Display and Screen Keys	3-3	3.4.3.4 'Bus address'	3-10
3.2.2.2 'OSCILLOSCOPE CALIBRATOR' Panel	3-3	3.4.3.5 'Printer'	3-11
3.2.2.3 Output Connections	3-3	3.4.3.6 'Power-up mode'	3-11
3.2.2.4 'Procedure' and 'Results' Memory Card Slots	3-3	3.4.3.7 'NEW PASSWORD'	3-12
3.2.2.5 'Standby' Push-Button	3-3	3.4.3.8 'CALIB Password'	3-12
3.2.2.6 Power On/Off Switch	3-3	3.4.3.9 'CONFIG Password'	3-12
3.2.3 Output Controls	3-4	3.4.3.10 'Ext ref in'	3-13
3.2.3.1 Front Panel Control Sets	3-4	3.4.3.11 'Ext ref out'	3-13
3.2.3.2 Entry to Manual Mode	3-4	3.4.3.12 'DATE TIME'	3-13
3.2.3.3 Manual Mode — Typical Menu Screen	3-4	3.4.3.13 'HEAD CONFIG'	3-14
3.2.3.4 Editing on the Screen	3-4	3.4.3.14 'MORE' Configuration	3-14
3.3 Preferences		3.4.3.15 'Language'	3-14
3.3.1 Pref Selection	3-6	3.4.3.16 'Border line'	3-14
3.3.1.1 Pref Overview	3-6	3.4.3.17 'Results card'	3-15
3.3.1.2 Changing the Parameters	3-6	3.4.3.18 'Engineers Notes'	3-15
3.3.1.3 Screen Contrast	3-6	3.4.3.19 'Certificate'	3-16
3.3.1.4 Scope Mode Amplitude Steps	3-6	3.4.3.20 'CERT STYLE'	3-16
3.3.1.5 Scope Mode Time Steps	3-6	3.4.3.21 'PAGE SETUP'	3-16
3.3.1.6 Deviation Display	3-7	3.4.3.22 'Start page number'	3-16
		3.4.3.23 'Page length, header and footer sizes'	3-17
		3.4.3.24 'Pass indicator'	3-17
		3.4.3.25 'Appended message'	3-17
		3.4.3.26 'LAB DETAILS'	3-17
		3.4.3.27 'LAB NAME'	3-17
		3.4.3.28 Laboratory Temperature and Humidity	3-17
		3.4.3.29 'CLEAR USER LIST'	3-18
		3.4.3.30 '*IDN CONFIG'	3-18
		3.4.3.31 'CAL Alarms'	3-18

Final Width = 215mm

---

## 3.2 Introduction to the Front Panel

### 3.2.1 Local and Remote Operation

#### 3.2.1.1 Remote, Semi-Automatic and Manual Calibration of UUT Oscilloscopes

The 9500B has been designed to present three main user interfaces for control of UUT calibration:

- Fully-automatic operation for UUT oscilloscopes which are remotely controllable on the IEEE-488 Instrumentation Control Interface, employing IEEE-488.2/SCPI protocols. The 9500B also includes emulation modes which minimize the software effort required for integration into existing calibration systems designed around Tektronix CG5011 and SG5030 calibrators. Refer to *Section 6*.
- Semi-automatic operation using procedure memory cards to drive the 9500B, with control of the subject UUT being implemented by a form of the UUT manufacturer's procedure through a series of user prompts. Refer to *Section 5*.
- Manual operation from the front panel, again with control of the subject UUT being implemented by the UUT manufacturer's procedure. Refer to *Section 4*.

#### 3.2.1.2 Use of Procedure Memory Cards

This is a form of assisted (semi-automatic) calibration, in which a memory card for a specific UUT oscilloscope is inserted into PCMCIA SLOT 1. Running Procedure Mode will generate instructions to the operator, while setting output values on the 9500B. The sequence of these instructions and outputs, the output specifications and the pass/fail limits conform the UUT manufacturer's calibration procedure.

#### 3.2.1.3 Manual and Remote Calibration of the 9500B Itself

The 9500B itself must periodically be verified or calibrated against suitable traceable standards. The calibration processes for the mainframe and Active Heads are available manually, but to gain the advantages of simplicity and throughput provided by automated procedures, these process commands are also available via the remote interface (IEEE-488.2/SCPI protocols - *Section 6*.). The 9500B communicates with programmable standards under the direction of external Control Software.

#### 3.2.1.4 General Arrangement of Front Panel Controls

The front panel is divided into three main areas:



Center: A 'Menu' and 'Output Display' LCD screen, with grouped soft keys.

Right: A control panel, used to select and adjust operational Functions and Modes, with two slots to accept memory cards.

Left: Output Connectors, used for connection of the active heads.

These features are described in the following paragraphs.

---

## 3.2.2 Front Panel Features

### 3.2.2.1 Liquid Crystal Display and Screen Keys





The 9500B communicates with the operator by presenting essential information on the LCD screen. For example: the output value generally appears in large characters below the center of the screen, accompanied by its units. An operator can move through a series of menu screens, choosing options from those presented on the screen.

Eleven soft keys ('screen' keys) are grouped below and to the right of the screen. These are labelled by characters or symbols representing menu choices, which appear in reserved display areas on the screen next to the keys. Main functions are selected by buttons on the 'Oscilloscope Calibrator' panel.

#### 3.2.2.2 'OSCILLOSCOPE CALIBRATOR' Panel

This panel carries the main controls used to select the operational functions and modes of the calibrator:

- a. **Major Function** keys are used mainly in Manual mode (*Section 4*) and Calibration mode (*Section 10*). They are arranged down the right edge:

-  : Waveform (select Square with direction, or  $\pm$ DCV using screen keys).
-  : Sinewave (select amplitudes and frequency using screen keys and cursor controls).
-  : Edge (select polarity using screen keys).
-  : Timing Markers (select Waveform and Frequency/Period using screen keys — including Line Frequency).
- Aux** : Auxiliary Functions (select Current, Composite Video, Linear Ramp, Overload Pulse, UUT Input Leakage Test, Auxiliary Input, Channel Skew, and Load Resistance or Load Capacitance measurement using screen keys).

- b. **Mode** Key, under the Function keys. The modes are: 'Procedure', 'Manual', 'Configuration', 'Calibration' and 'Test' (*refer to sub-section 3.4*).
- c. **Preferences** Key, the bottom key. The user-preferences provided are display adjustments of: 'Screen Contrast', 'Amplitude step' factor sequence, 'Time step' factor sequence and Deviation/UUT Error toggle (*refer to sub-section 3.3*).
- d. **OUTPUT OFF** and **ON** keys, with an 'ON' state indicator LED, in a separate column due to their importance.
- e. **Alpha-numeric** keypad, used for various purposes, to be described later.
- f. **The  (Tab) key, Cursor keys and Spinwheel:** These select and increment or decrement displayed quantities.

#### 3.2.2.3 Output Connections

The ten output connectors are located on the left of the panel. Use of these connectors is described in *Section 4*.

#### 3.2.2.4 PCMCIA SLOT 1 and PCMCIA SLOT 2

These slots are included mainly for Procedure mode (*Section 5*), although there are secondary uses.

#### 3.2.2.5 'Standby' Push-Button

Pressing this button, in the bottom right corner of the front panel, will toggle between normal operation (LED green) and 'standby' (LED red). The instrument will transfer automatically from normal operation to standby some 15 minutes after the most recent operation, then pressing the button will immediately restore normal operation.

#### 3.2.2.6 Power On/Off Switch

Line power to the 9500B is switched On and Off using a switch at the left of the instrument, on the rear panel. Up is On; Down is Off.

Final Width = 215mm

### 3.2.3 Output Controls

The aim of this discussion is to become familiar with the 9500B interactive display, and the manipulation of front-panel controls.

We have chosen DC/Square as a *typical* function for manipulation (it is also likely to be the most familiar to most new operators).

Full details of the DC/Square function are not given here, they appear in *Section 4 Subsection 4.5*.

#### 3.2.3.1 Front Panel Control Sets

We have already seen that there are two sets of front-panel controls which manipulate the output configuration, but briefly, to establish a base-line, here they are again:

1. Controls positioned in the right half of the front panel. They are:
  - a. **Major Function** keys, arranged in a column down the right edge.
  - b. Moving left, the **OUTPUT OFF** and **ON** keys, arranged in a separate column because of their importance.
  - c. **Alpha-numeric** Keypad.
  - d. **Cursor Controls**:  
See *paras 3.2.3.4*.
2. **Screen Soft Keys**, around the display itself, are used to select sub-functions and individual parameters (identified in the areas used as screen key labels).

Before we proceed, we need to identify the components present on a typical menu screen. A representation of a DC/Square display in Manual mode is given as *Fig 3.2.1*.

#### 3.2.3.2 Entry to Manual Mode

This discussion is conducted in Manual mode, which you may not recognize at present. Refer to *paras 3.4.1*. To enter MANUAL mode:

1. Press the front panel **Mode** key;
2. Press the **MANUAL** screen key beneath the display.

#### 3.2.3.3 Manual Mode — Typical Menu Screen

Ensure that the 9500B is installed and switched on as in *Section 2*. If, after selecting Manual mode, the display does not correspond to *Fig. 3.2.1*, press the  key in the top right corner of the front panel.



Familiarize yourself with *Fig. 3.2.1*. This is the default version of the menu screen which will appear when you enter DC/Square function for the first time (unless the default has been changed in Config Mode).

**N.B.** Contrast inversions of symbols and fields indicate those elements which have been selected, 'Scope Mode' (1-2-5) only in this case.

#### 3.2.3.4 Editing on the Screen

We have already mentioned 'Scope Mode'. This is not a major mode of the same importance as Manual mode, but identifies a specific means of making selections or entering changes on the screen.





In all editing, the **Tab key**  is used to select the required variable for adjustment.



There are two modes, selected by the right-most soft key on the bottom row beneath the screen, which toggles between 'Direct' mode  and 'Scope' mode  encompassing three main ways of adjusting values presented on the screen:

##### 1. Direct Mode

Once the  key has selected the required variable, two triangular markers presented above and below a digit in the selected numeric value form a cursor, and two methods of value adjustment are available:

##### a. Digit Edit.

**Cursor keys:**  and  control the screen cursor to select a digit for adjustment, then  increments and  decrements the digit selected by the cursor.

**Spinwheel:** Increments or decrements the selected digit, in place of the  and  keys.

**b. Numeric-Entry Edit.**

**Key Pad:** Typing any character on the numeric keypad will set up a 'box' beneath a smaller version of the selected numeric value, and place the typed character in the box. The right side key labels change to give a choice of units.





**Units:** After the new value has been typed on the keypad, the required units can be chosen from the right side soft keys. Pressing one of these keys will cause the display to revert to the 'Digit Edit' format, with the same numeric value remaining selected by the two triangles.

**'Enter':** The keypad 'Enter' (␣) key can be used instead of one of the units keys to revert to 'Digit Edit' format. In this case the 9500B firmware will always impose the basic units (not multiples or sub-multiples).

**Further Use:** Either Digit Edit or Numeric-Entry Edit can be used for all selectable variables on the screen.

**3. Scope Mode**  1.  $\bar{\square}$

This mode differs from Direct Mode only in that adjustment of many screen variables is constrained to a series of 'Stepped Values', which run in a sequence of 1 : 2 : 5 factor steps (The 'Pref' facility, described overleaf, can be used to change the factor sequence to match certain oscilloscopes with 1 : 2 : 2.5 : 4 : 5 steps). Selecting one of these variables places a 'barred' cursor above and below the whole numeric value (shown in Fig 3.2.1), and only one method of value adjustment is available:

**Cursor keys:**  and  are not used. Adjustment is carried out using the  and  keys (or spinwheel) to increment or decrement the whole value through the pre-defined factor steps.

These forms of editing are also described in greater detail, with illustrations, in Section 4, sub-section 4.4.

Final Width = 215mm

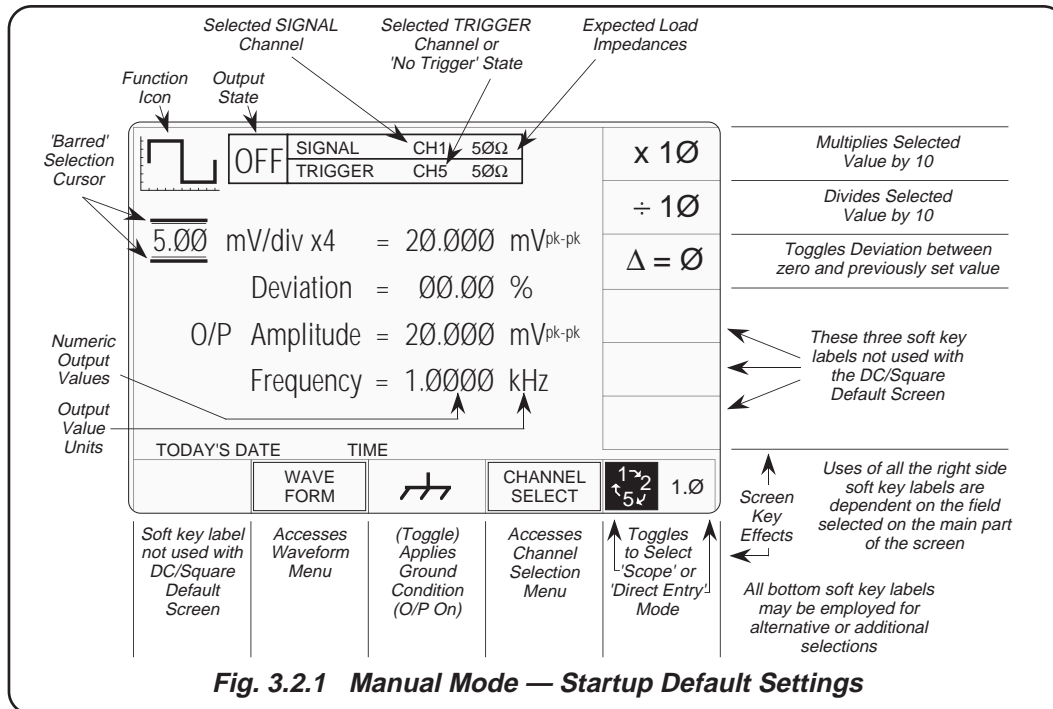

**Fig. 3.2.1 Manual Mode — Startup Default Settings**

### 3.3 Preferences

#### 3.3.1 Pref Selection

The Pref key is highlighted in Fig. 3.3.1, below:



Fig. 3.3.1 'Pref' Key

Final Width = 215mm

##### 3.3.1.1 Pref Overview

The Pref key sets up a special display which offers adjustment of four parameters, shown in Fig. 3.3.2. This menu can be exited **only** by pressing **EXIT**, or re-pressing the **Pref** key.

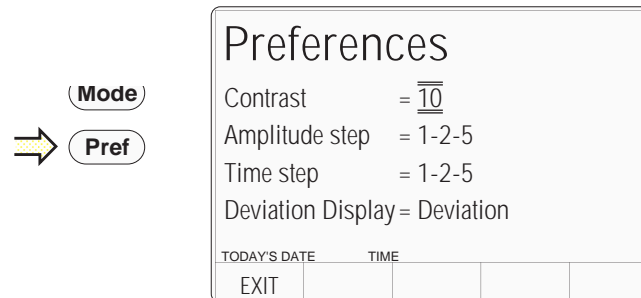

Fig. 3.3.2 'Pref' Parameters

The **Preference** screen can be displayed in all modes and functions without disturbing the function setup (except that under certain conditions with **OUTPUT ON**, the output will be turned off).

Preference selections are non-volatile. Once a parameter has been set up as required, it will be remembered by the 9500B through changes of mode and function, also being restored after Power down / Power up.

##### 3.3.1.2 Changing the Parameters

The mechanism for adjusting parameters is known as 'Digit Edit'. A **Cursor** of horizontal lines enclosing screen characters indicate the parameter selected for adjustment. This can be moved from one parameter to another using the **(Tab)** key.

Once the cursor has been moved to the required parameter, the adjustment is carried out using either the spinwheel or the **(Up)** / **(Down)** cursor keys. The Left and Right cursor keys have no effect.

##### 3.3.1.3 Screen Contrast

The front panel screen is viewable from a wide range of vertical and horizontal angles. For best contrast at a fixed angular sight line in the vertical plane, the 'Contrast' parameter on the screen can set the sight line to one of twenty-seven different angles, represented by the numbers 1-27. The range from numbers 10-12 will provide good contrast from head-on viewing positions.

To change the contrast:

1. Use the tab key to position the cursor on the contrast number.
2. Use the spinwheel or up/down cursor keys to adjust for your best display contrast, by increasing or decreasing the contrast number.

##### 3.3.1.4 Scope Mode Amplitude Steps

For most UUT oscilloscopes, amplitude sensitivity can be increased or decreased at values which run in a sequence of 1 : 2 : 5 factor steps. The Scope Mode 'Amplitude step' parameter can change the sequence to match certain oscilloscopes with 1 : 2 : 2.5 : 4 : 5 factor steps.

To change the Amplitude steps parameter:

1. Use the tab key to position the cursor on the Amplitude steps sequence.
2. Use the spinwheel or up/down cursor keys to toggle between 1—2—5 and 1—2—2.5—4—5 factor steps.

##### 3.3.1.5 Scope Mode Time Steps

This operates on the same basis as Amplitude steps, but the result is a change in output period (and frequency) in the chosen factor steps.

To change the Time steps parameter:

1. Use the tab key to position the cursor on the Time steps sequence.
2. Use the spinwheel or up/down cursor keys to toggle between 1—2—5 and 1—2—2.5—4—5 factor steps.



---

### 3.3.1.6 Deviation Display

The deviation of an output signal amplitude from the factored output step value is controllable, within  $\pm 11.2\%$ , from the function screen. So a signal of 1V DC can be adjusted from 0.8880V to 1.1120V using the deviation control.

To extend the usefulness of this facility, the deviation display value can be expressed as 'UUT Error'. This permits use of the deviation control to adjust the 9500B output until the UUT oscilloscope presentation itself shows the required value. The 9500B output value can be read off, but in addition, the UUT's error is presented on the 9500B screen.

Note that both the UUT error and the deviation are expressed as a percentage (ratios). This means that if the deviation has to be adjusted to +10.00%, the UUT error is -9.091%. An example will show why:

*Example of 'UUT Error'*

1. Assume a 1V UUT nominal cal point.
2. 9500B set to 1V: UUT reading is low.
3. 9500B 'Deviation' increased until UUT reading is 1V nominal — Deviation value is +10% and 9500B output is 1.1V.
4. A UUT reading of '1V' represents  $1.1 \times 1V$ , so UUT original reading for 1V input was  $1V \div 1.1 = 0.909091V$ .
5. The UUT Error is therefore  $0.909091V - 1V = -0.09091V$ .
6. The UUT percentage Error is  $(0.909091V \div 1V) \times 100\%$ ,  
= -9.09091%

To change the Deviation parameter:

1. Use the tab key to position the cursor on the Deviation display parameter.
2. Use the spinwheel or up/down cursor keys to toggle between 'Deviation' and 'UUT Error'.

*Final Width = 215mm*

### 3.4 Modes of Operation

#### 3.4.1 Mode Selection

The Mode key is highlighted in *Fig. 3.4.1*, below:

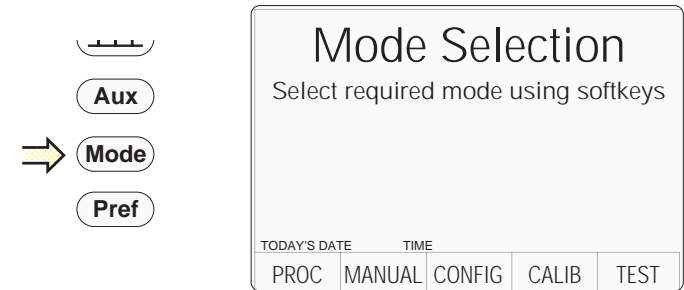

**Fig. 3.4.1 'Mode' Key**

Final Width = 215mm

##### 3.4.1.1 Mode Overview

The Mode key sets up a special menu display, offering selection from five primary modes. This menu can be exited **only** by pressing one of the five screen keys.



**Fig. 3.4.2 Mode Selection Menu**

Four of the modes are described in later sections, but because of its wide-ranging effects, Configuration Mode is dealt with in this section. The five modes are:

**PROC = Procedure Mode:**

For calibration of a specific type of UUT, the sequence of 9500B output selections is determined by a 'Procedure' memory card, placed in the left-hand PCMCIA SLOT 1 beneath the panel outline. Results can be printed, or recorded in a second 'Data' card, placed in the right-hand PCMCIA SLOT 2. Refer to *Section 5*.

**MANUAL = Manual Mode:**

The output is selected and adjusted entirely from the front panel. Refer to *Section 4*.

**CONFIG = Configuration Mode:**

On entry to Configuration mode, parameters are protected by password. These include: *Power-On default mode (Manual or Procedure modes); Present Time and Date; Enable Printing; Reformat Printed Certificates; etc.* Refer to *Sub-section 3.4.2*.

**CALIB = Calibration Mode:**

This mode is protected by switch and password. On entry to Calibration mode, the operator can process the calibration of the 9500B itself. Calibration can be controlled from the front panel, or via the IEEE-488 Interface. Refer to *Section 10*.

**TEST = Test Mode:**

This mode permits an operator to initiate and interact with any of a series of tests as follows: 'Base'; 'Heads'; 'All'; 'Fast' or 'Interface'. Refer to *Section 8*.

### 3.4.2 Passwords and Access

1. All Configuration mode selections require a password. When the 9500B is shipped from new, the password requirement is enabled to avoid unauthorized access.
2. *It is recommended that both passwords be changed, for security purposes, at the earliest opportunity.*
3. The shipment 'Configuration' password is **12321** (as typed on the front panel keypad when the Password Entry screen for Configuration mode is showing). It is stated here to allow entry to Configuration mode by personnel *authorized by local management*, and permit subsequent access to the means of altering the password itself. The necessary process is detailed later in this sub-section.
4. A second (different) password will be required to allow entry to Calibration mode *as authorized by local management*. The shipment version of the Calibration mode password is **2→3→5→7** (as typed on the front panel keypad when the Password Entry screen for Calibration mode is showing) The necessary process for changing *this* password is also detailed later in this sub-section.

### 3.4.3 Configuration Mode

Configuration Mode is used to change the settings of those parameters which have been placed under user control.

**N.B.** A password is required for access to change settings.

When changing configuration, start as follows:

1. Press the **Mode** key to obtain the 'Mode Selection' menu screen.
2. Press the **CONFIG** screen key at the center of the bottom row to progress into 'Configuration' mode. The 9500B will transfer to the 'Configuration' menu screen:

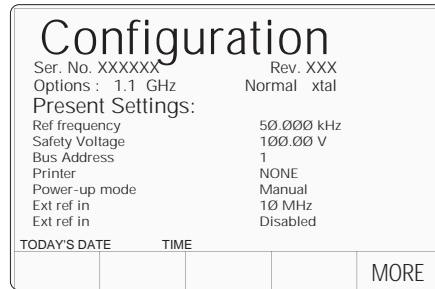

3. The screen shows the present settings of some of the parameters which can be changed in Configuration mode.
4. The screen also indicates which hardware Option 9500B/600, 9500B/1100 or 9500B/3200 is fitted. These cannot be changed in Configuration mode.

#### 3.4.3.1 'MORE' Configuration

1. To gain access to alter Configuration mode options, a password will be required. (Refer to the arrangements made for 'shipment' passwords described in *Para 3.4.2*)
2. The password requirement will be invoked by pressing the **MORE** screen key on the right of the bottom row. The 9500B will transfer to the 'Password Entry' screen:
3. When you enter your password using the

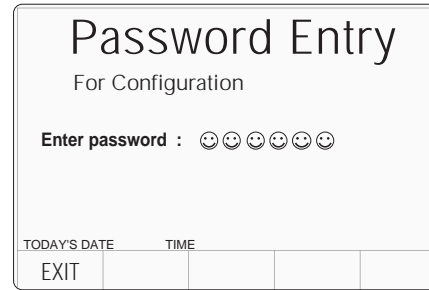

alpha-numeric keypad, security icons will appear on the screen as you type. Finally press the ↵ key.

If the password is incorrect: an error message will be given and the security icons will be removed, enabling a new attempt to enter the password.

The **'EXIT'** screen key acts to escape, back to the previous screen.

4. The correct password, followed by ↵, will provide entry to the main 'Configuration' menu screen, showing the present settings of the parameters which now can be changed using screen keys whose labels appear on the display:
5. Pressing the **'MORE'** key again will

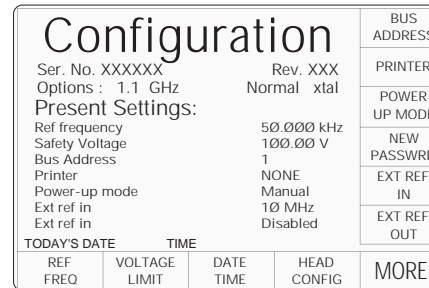

provide entry to a second 'Configuration' menu screen, showing the present settings of other parameters. *Refer to para 3.4.3.14.*

### 3.4.3.2 'Ref Frequency'

#### Use of Reference Frequency

The reference frequency is used mainly in assessments of UUT oscilloscope bandwidth, a commonly used frequency for this purpose being 50kHz. In the 9500B, for ease of operation in certain functions, the output can be changed from the selected frequency to the reference frequency and back by a simple toggle switching action.

In the 9500B, the default reference frequency is set at 50kHz, but users can change this in Configuration mode to match the frequency used in procedures for individual oscilloscopes.

1. For access to alter the reference frequency, press the **REF FREQ** screen key at the bottom left of the 'Present Settings' screen.
2. This transfers to a configuration screen designed for changing the 'Ref Frequency'. The default value is shown:

<b>Configuration</b>		50kHz DEFAULT
The REFERENCE FREQUENCY can be changed by using direct editing only.		
Ref = 50.00 kHz		
TODAY'S DATE	TIME	
EXIT		

3. Use Direct edit to set the required reference frequency. After typing the value press the  $\downarrow$  key on the keypad (the Direct edit 'V' screen key in the right-hand column will perform the same action).
4. The '50kHz DEFAULT' screen key on the right can be used if 50kHz is required.
5. Press the **EXIT** screen key to return to the 'Present settings' menu screen. The new reference frequency appears on the 'Present Settings' list.

### 3.4.3.3 'Safety voltage'

#### High Voltage Warnings — Warning and Interlock

In the interests of safety, to avoid electric shock, the 9500B incorporates a high-voltage warning and interlock system for both DC and Square Voltage functions. The limit can be set to any voltage from 10V to 110V. The default warning threshold value (100V) can be changed in Configuration mode. The active threshold value is stored in non-volatile memory.

When the output is on in DC/Square or High Edge function, the warning will sound when the output voltage setting is raised to or above the threshold value. The output will stay at its previous value until the user confirms the new voltage by re-pressing the **OUTPUT ON** button.

1. For access to allow the high voltage warning threshold to be altered, press the **VOLTAGE LIMIT** screen key on the 'Present Settings' screen.
2. This transfers to a configuration screen designed for changing the 'Voltage Limit'. The default value is shown:

<b>Configuration</b>		DEFAULT 100 V
The high voltage warning limit can be changed by using direct editing only.		
The maximum value is 110V		
Limit = 100.00 V		
TODAY'S DATE	TIME	
EXIT		

3. Use Direct edit to set the required high voltage warning limit. After typing the value press the  $\downarrow$  key on the keypad (the Direct edit 'V' screen key in the right-hand column will perform the same action).
4. The 'DEFAULT 100V' screen key on the right can be used if 100V is the required level.

5. Press the **EXIT** screen key to return to the 'Present settings' menu screen. The new high voltage threshold value appears on the 'Present Settings' list.

#### Note: Out-of-Range Indication

The valid range of limit values is from 10V to 110V. When values outside this range are entered, an error message will appear on the screen, and the 'EXIT' screen key label will be replaced by 'OK'. By pressing 'OK' the original value is reinstated and the message disappears, for a second attempt.

### 3.4.3.4 'Bus address'

#### Remote Operation via the IEEE-488 interface — Addressing the 9500B

When the 9500B is set for remote operation, control is removed from the front panel and given to an external controller.

Communication is set up between the 9500B and its controller via the IEEE-488 bus, connected into an interface within the 9500B.

Commands from the controller are addressed to the 9500B using an address code, which can be a number in the range 0-30. For the 9500B to respond, this number must be matched by the same number programmed into the 9500B using the procedure given below.

Remote operation of the 9500B via the IEEE-488 interface is described in *Section 6*.

**N.B.** The correct bus address is necessary to use remote commands, but remote operation is available only when the instrument is in **MANUAL** or **CALIBRATION** mode.

1. The 9500B IEEE-488 bus address can be set to any number within the range 0 to 30. For access from the 'Present Settings' screen, press the **BUS ADDRESS** screen key at the top right.
2. The 9500B transfers to the 'IEEE 488 ADDRESSES' screen:

Configuration		9500B	
IEEE 488 ADDRESSES		5000 SERIES	
9500B address= 22			
2nd address inactive			
Change by direct edit only.			
TODAY'S DATE	TIME		
EXIT			

- Use numeric entry to set the required bus address number. Type the number on the keypad, then press the ↵ key.
- Press EXIT to return to the 'Present Settings' screen.

For second address (5000-series emulation), refer to *Section 6, Appendix F*.

### 3.4.3.5 'Printer'

#### Printer Operation (Procedure Mode and Test Mode only)

Using the Procedure mode print facility, the 9500B can deliver a printed certificate, whose style is also determined in Configuration mode.

In Test mode, test results can also be printed — in a pre-determined format. The results are stored until the print command is given after the test is over. The printer does not need to be selected in Configuration mode, unless the results print is required to conform to the layout of a particular type of printer.

The printer is set up only when an attempt is made to print, following two types of occasion:

- printer type is changed in Config mode;
- 9500B is powered on.

#### Printer Type Selection

- For access to select and enable a particular printer type (or one using the same formatting), press the **PRINTER** screen key on the 'Present Settings' screen.
- This transfers to a 'Configuration' screen to change 'The current printer type':

Configuration		DISABLE	
The current printer type is indicated by the highlight.		EPSON	
Use the softkeys to select another.		BUBBLE JET	
		DESK JET	
		USER DEFINED	
TODAY'S DATE	TIME		
EXIT			

- Power-on default is **DISABLE**. Use the screen keys to select the type of printer on the interface, or to disable direct printing.
- EXIT** returns to the 'Present Settings' menu screen.

#### User Defined Printer Type

- If the type of printer you are using does not conform to one of those listed, press the **USER DEFINED** screen key. This transfers to a 'Configuration' screen designed to enter the initialisation control codes for your printer:

Configuration			
Enter the initialisation control codes in decimal and confirm with enter.			
The current control code string is: (string appears here eg 27 116 1 18 15)			
Enter a new control string:			
TODAY'S DATE	TIME		
EXIT			

- Obtain the initialisation control codes from your printer's operating manual. If necessary, convert the codes to decimal. Use the 9500B keypad to type the decimal codes, separated by spaces (→): the new string replaces the old. Press the ↵ key.
- EXIT** returns to the 'current printer type' screen.

### 3.4.3.6 'Power-up mode'

#### Mode Selection at Power-on

Users can determine which mode will be selected automatically at power-on, choosing between Procedure mode and Manual mode. The 9500B cannot be made to power-up in any other mode.

To set the power-up default mode use the procedure in the column on the right.

- For access to change the default mode, press the **POWER UP MODE** screen key on the 'Present Settings' screen.
- This transfers to a 'Configuration' screen to change 'The default power-on mode':

Configuration		PROC	
The default power-on mode is indicated by the highlight.		MANUAL	
Use the softkeys to select another.			
TODAY'S DATE	TIME		
EXIT			

- To change the default, press the required screen key on the right.
- Press EXIT to return to the 'Present Settings' screen

The new default will be incorporated into the list. Next time the line power is turned from **OFF** to **ON**, the 9500B will power-up in the selected mode.

(continued overleaf)

### 3.4.3.7 'NEW PASSWORD'

#### Changing the Passwords

Two passwords are required (they can be the same or different):

- for entry to Configuration mode;
- to enter Calibration mode (for calibration of the 9500B itself).

Refer to para 3.4.2. When the 9500B is shipped from new, the password requirement is enabled to avoid unauthorized access (*refer to para 3.4.2*). The shipment Configuration and Calibration passwords allow initial access to the two modes, but should be changed as soon as entry has been gained into Configuration mode.

The passwords are changed using the following:

#### To change either the CALIB or CONFIG password

1. On the 'Present Settings' menu screen, press the **NEW PASSWORD** screen key on the right. This transfers to the 'Select the Password' screen:
2. Select the password to be changed, via one

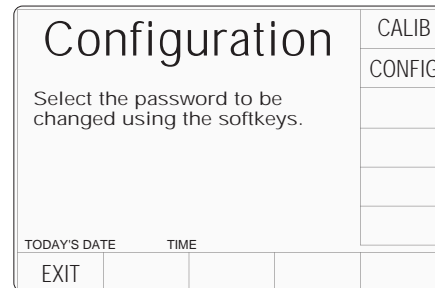

of the two screen keys on the right.

3. The **EXIT** screen key reverts to the Present Settings' screen.

### 3.4.3.8 'CALIB' Password

#### To Change the Calibration Mode Password

1. On the 'Select the password' screen, press the **CALIB** screen key on the right. This transfers to the 'Enter new calib password' screen:

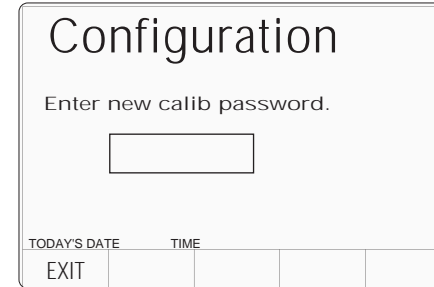

(To cancel an attempt, press the EXIT key. This will revert to the 'Select the password' screen.)

2. Type the new password using the alphanumeric keyboard, and finish with ↵. The 9500B will ask for the password to be entered again, to confirm it.
3. Retype the same password; finish with ↵. If the second password is different from the first, the 9500B will reject both, and the process must be repeated. If both passwords are the same, the 9500B will accept the new password, and revert to the 'Select the password' screen.

**Note:** The shipment version of the 'Calibration' password is 2→3→5→7.

### 3.4.3.9 'CONFIG' Password

#### To Change the Configuration Mode Password

1. On the 'Select the password' screen, press the **CONFIG** screen key on the right. This transfers to the 'Enter new config password' screen:

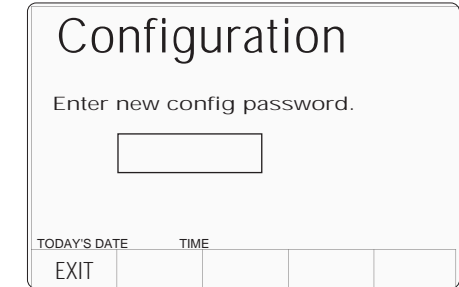

(To cancel an attempt, press the EXIT key. This will revert to the 'Select the password' screen.)

2. Type the new password using the alphanumeric keyboard, and finish with ↵. The 9500B will ask for the password to be entered again, to confirm it.
3. Retype the same password; finish with ↵. If the second password is different from the first, the 9500B will reject both, and the process must be repeated. If both passwords are the same, the 9500B will accept the new password, and revert to the 'Select the password' screen.

**Note:** The shipment version of the 'Configuration' password is 12321.

### 3.4.3.10 'Ext ref in'

#### Reference Frequency Input

A BNC connector on the 9500B rear panel accepts reference frequency inputs from 1MHz to 20MHz in 1MHz steps, from a TTL source.

1. On the 'Present Settings' screen, press the **EXT REF IN** screen key to transfer to the 'Change the reference source' screen (default shown).
2. To change the reference source, press the required screen key on the right:

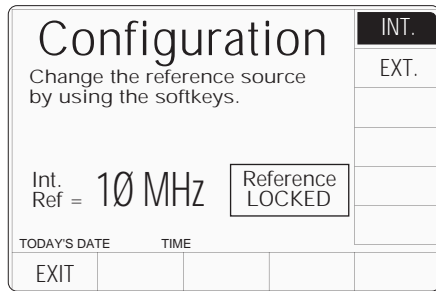

3. When switched to 'EXT.', use the up/down cursor control or spinwheel to inform the 9500B of the source frequency. Ensure that the required source is connected and operating.

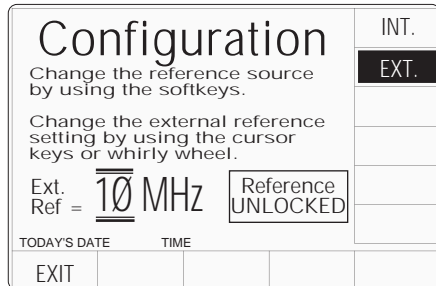

4. Press **EXIT** to return to the 'Present Settings' screen.

The new external reference frequency is available to enhance the 9500B internal clock.

### 3.4.3.11 'Ext ref out'

#### Reference Frequency Output

A BNC connector on the 9500B rear panel provides a reference frequency output at either 1MHz or 10MHz, from a 50Ω source (VSWR < 1.2 to 100MHz). This can use the 9500B internal clock to enhance the frequency accuracy of other devices.

1. On the 'Present Settings' screen, press the **EXT REF OUT** screen key to transfer to the current external reference output' screen (default shown):

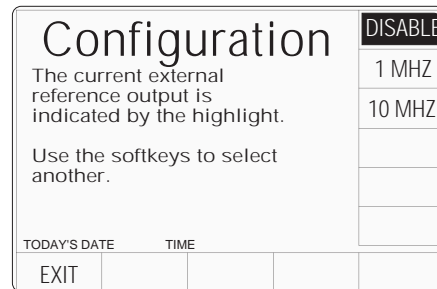

2. To change the external reference output, press the required screen key on the right:
3. Press **EXIT** to return to the 'Present Settings' screen.

The selected external reference frequency is either disabled, or applied to the 'REF FREQUENCY OUTPUT' BNC connector on the rear panel.

### 3.4.3.12 'DATE TIME'

#### Date and Time Settings

A real-time clock, supported by an internal battery, presents the date and time at the bottom of many screens. It is also used to generate the date to appear on direct-printing certificates in Procedure mode. Users have access via Configuration mode to correct the date and time (for instance: to accommodate daylight saving changes, and crossing time-zones).

1. Press the **DATE TIME** screen key on the 'Present Settings' screen, for access to allow the date and time to be altered.
2. This transfers to a configuration screen designed for changing the date and time. Our representation shows the current date from a previous setting:

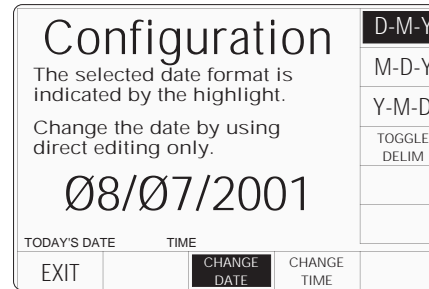

3. Press the appropriate right screen key to set the required date format, and use the keypad to correct the date, (using *non-alphanumeric characters as delimiters*), followed by ↵. The new date will appear with delimiters as set by the 'TOGGLE DELIM' key, which merely switches between 'slash' (/) and 'period' (.) only.
5. To correct the time, press the **CHANGE TIME** screen key to transfer to the 'Change the time' screen, then use the alpha-numeric keypad to enter the present time:

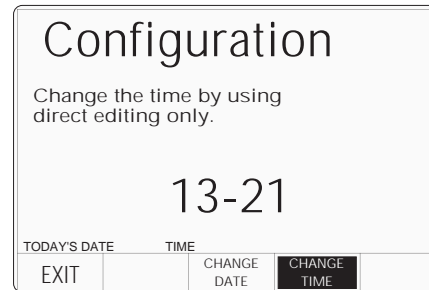

6. Press the **EXIT** screen key to return to the 'Present settings' menu screen. The updated *corrected* date and time, will appear wherever they are used.

### 3.4.3.13 'HEAD CONFIG'

#### Information only

Pressing the 'HEAD CONFIG' key provides a screen which indicates the type, serial no., cal date and cal due date for each head fitted:

Configuration			
Type	S/N	Cal Date	Due Date
1	9510	XXXX	XX/XX/XXXX
2	9510	XXXX	XX/XX/XXXX
3	No	Head	00/00/0000
4	9510	UNDEFINED	00/00/0000
5	No	Head	00/00/0000
TODAY'S DATE		TIME	
EXIT			

Head calibration stores head details and calibration corrections, specific to that head, regardless of the base unit to which it is fitted. The above screen presents the stored details derived from the fitted heads.

### 3.4.3.14 'MORE' Configuration

After exiting to the 'Present Settings' screen, pressing the 'MORE' key will provide entry to a second 'Configuration' menu screen, showing the present settings of other parameters (generally associated with Procedure mode) which can be changed using screen keys whose new labels appear on the display:

Configuration		SELECT LANG
Ser. No. XXXXXX	Rev. XXX	BORDER LINE
Options : 1.1 GHz	Normal xtal	RESULTS CARD
Present Settings:		ENG NOTES
Language	English	CERT DETAILS
Border line	70.00	CLEAR USER LIST
Results card	Disabled	
Engineers Notes	Disabled	
Certificate	Style 1	
TODAY'S DATE		TIME
EXIT		

The 'EXIT' screen key acts to escape, back to the first Configuration menu screen.

If it desired to revert to the Mode Selection display, press the front panel 'Mode' key.

### 3.4.3.15 'Language'

#### Language Considerations

The 9500B default language is English. It is possible to change the language used in Procedure mode, but not in any of the other modes.

For Procedure mode the language of the introductory screens can be changed (these are stored within the 9500B itself).

The language used in a procedure card is determined and registered on the card, within the procedure header, at the time that the procedure is created (Portocal II can perform this function). When the procedure card is being used in the Model 9500B, the language cannot be changed.

This facility allows users to alter the language used in the introductory screens of Procedure mode:

Configuration		ENGLISH
The current language is indicated by the highlight.		FRENCH
Use the softkeys to select another.		GERMAN
		SPANISH
		ITALIAN
TODAY'S DATE		TIME
EXIT		

1. On the 'Present Settings' screen, to transfer to the 'Current language' screen, press the **SELECT LANG** screen key:
2. To change the Procedure mode language, press the required language screen key on the right.
3. Press **EXIT** to return to the second 'Present Settings' menu screen.

The new language will be used the next time that Procedure mode is entered.

### 3.4.3.16 'Border line'

#### Test Point Specifications — 'Borderline' Reporting

For users who wish to know when a UUT is drifting towards the limits of (while still within) the manufacturer's specification, it is useful to provide some 'borderline' indication. This can be expressed as a percentage of the manufacturer's specification for each test point, beyond which the indication will be given.

In the figure, the pass, borderline and fail regions of the specification tolerance are indicated *at the test point*.

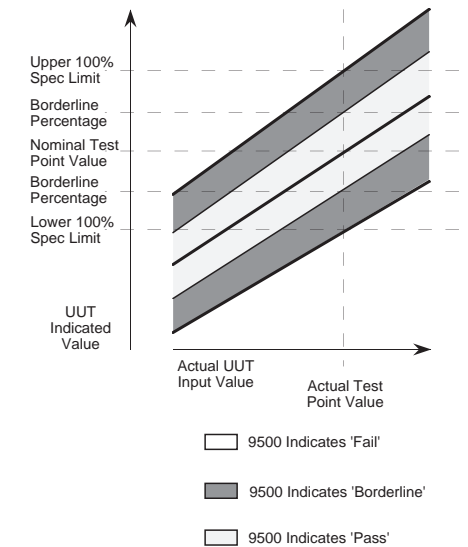

When in Procedure mode, the direct-printing certificate (Style 1), and the data on the 'Results' card, will report 'Borderline' test results. Users have access via Configuration mode to set the percentage for borderline reporting.

1. For access to allow the borderline reporting threshold to be altered, press the **BORDER LINE** screen key on the 'Present Settings' screen. This transfers to a configuration screen designed for changing the threshold (default value shown):



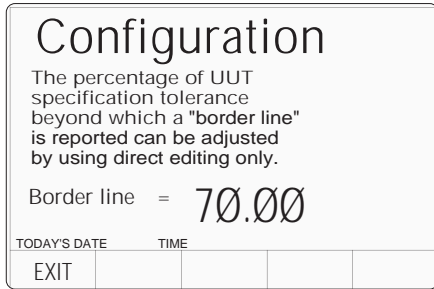

2. Use Direct edit to set the required percentage of specification tolerance. Results which lie between this percentage and 100% of tolerance will be reported as 'Border line'.
3. Press the **EXIT** screen key to return to the second 'Present settings' menu screen.

Subsequently, during each verification in Procedure mode, the 9500B will detect its own slewed output and place the UUT measurement error into the 'Pass', 'Border line' or 'Fail' category. When a (Style 1) certificate is printed, and on any active results card, each test point will indicate a 'Pass', 'Borderline' or 'Fail' result.

### 3.4.3.17 'Results card'

#### Formatting Results Memory Cards (Procedure Mode only)

In Procedure mode, the 9500B can deliver the results of a 'Calibrate' or 'Verify' procedure to a memory card inserted into PCMCIA SLOT 2 in the front panel (refer to Section 5 of this Handbook). Note that only SRAM cards can be used in the PCMCIA SLOT 2 drive.

New SRAM cards must first be formatted for the purpose. This can be carried out in Test mode, as part of the 'Card Slot Test' procedure (refer to Section 8), or within Portocal II software.

#### Caution!

During the formatting process, the Card Slot Test over-writes all data stored on the card in the slot, and sets up a new 'Results card header'.

Note:

It is not necessary to re-format a used card, with results already stored, for it to accept new data. New results data from Procedure mode runs will be concatenated with existing data until the card memory is full. Erasure of card contents should be done using Portocal II.

1. For access to enable Procedure mode results to be downloaded to a SRAM memory card in the front panel PCMCIA SLOT 2, press the **RESULTS CARD** screen key on the 'Present Settings' screen.
2. The 'RESULTS CARD' screen key transfers to 'The result card requirement' menu screen.

The power-on default is **DISABLE**.

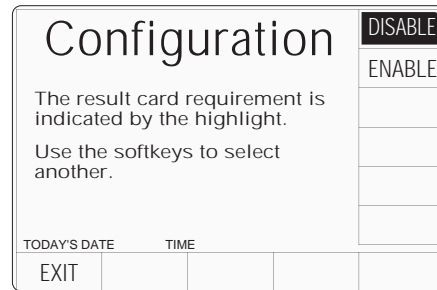

3. To enable or disable the facility, press the required screen key on the right of the screen. If enabled without a results card inserted in PCMCIA SLOT 2, the selected procedure will not run.
4. **EXIT** returns to the second 'Present Settings' menu screen.

### 3.4.3.18 'Engineers Notes'

#### Engineer's Notes

When a certificate is being prepared in Procedure mode, sometimes it will be desirable to insert additional information about special conditions, pertinent to the procedure which was carried out.

For instance: if the procedure was performed on a plug-in module of an oscilloscope, it may be desired to add the serial number of the oscilloscope mainframe, as well as the module's serial number.

If, in CONFIG mode, the 'Engineers Notes' are enabled, then an extra field will be added to the certificate entitled 'Additional Notes' in which any engineer's information can be entered. It will appear between the 'Calibration Standard' and 'Measurement Type' blocks.

The additional notes can be added on a screen which will be shown in Procedure mode when 'Engineers Notes' are enabled.

#### To Enable Engineers Notes

1. On the second 'Present Settings' menu screen, press the **ENG NOTES** screen key on the right. This transfers to the 'Eng notes requirement' screen:

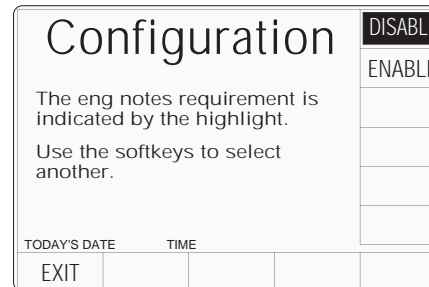

2. Press the **ENABLE** screen key on the right. The **DISABLE** key reverses the process.
3. The **EXIT** screen key reverts to the second 'Present Settings' screen.

### 3.4.3.19 'Certificate'

#### Results Certificates

In Procedure mode, three styles of printed certificate are available:

##### Style 1

This provides full information about each point tested, including applied and target values, spec limits and UUT error, % error pass/fail and test uncertainty ratio between 9500B and UUT.

##### Style 2

This is a shorter form of certificate, showing only the applied and target values, and the 9500B absolute uncertainty.

##### Style 3

This certificate is similar to Style 1, and has been added to accommodate the wider spec limits encountered during oscilloscope calibration, expressed in percentages rather than ppm.

Users are given the facility, in Configuration mode, to change the style of certificate to be printed.

1. For access to allow the certificate formatting to be altered, press the **CERT DETAILS** screen key on the second 'Present Settings' screen.
2. This transfers to what we shall refer to as a 'CERT DETAILS' screen:

Configuration		CERT STYLE
		PAGE SETUP
Present Settings:		PASS INDIC
Certificate	Style 1	APPEND MESSAGE
Start page number	1	LAB DETAILS
Page length	66	
Pass indicator	ON	
Appended message		
TODAY'S DATE      TIME		
EXIT		

**CERT DETAILS Screen Layout**

3. The 'CERT DETAILS' screen allows users to design a certificate by adjusting or selecting characteristics via screen keys on the right (refer to paras 3.4.3.20 to 3.4.3.28).
4. The **EXIT** screen key reverts to the second 'Present Settings' screen.

### 3.4.3.20 'CERT STYLE'

1. For access to select the certificate style, press the **CERT STYLE** screen key on the 'CERT DETAILS' screen. This transfers to 'The certificate type' screen, which allows the style of certificate to be selected:

Configuration		STYLE 1
		STYLE 2
The certificate type is indicated by the highlight.		STYLE 3
Use the softkeys to select another.		
TODAY'S DATE      TIME		
EXIT		

2. Press the key on the right which represents the required style of certificate.
3. Press the **EXIT** screen key to revert to the CERT DETAILS screen.

### 3.4.3.21 'PAGE SETUP'

1. To set up the certificate page, press the **PAGE SETUP** screen key on the 'CERT DETAILS' screen. This transfers to what we shall refer to as a 'PAGE SETUP' screen, which allows users to design the certificate page, using the keys on the right:

Configuration		START PAGE
		PAGE LENGTH
Present Settings:		HEADER SIZE
Start page number	1	FOOTER SIZE
Page length	66	
Header size	Ø	
Footer size	1	
TODAY'S DATE      TIME		
EXIT		

**PAGE SETUP Screen Layout**

2. Press the key on the right which describes the attribute to be changed.
3. The **EXIT** screen key to revert to the CERT DETAILS screen.

### 3.4.3.22 'Start page number'

1. To change the certificate start page number, press the **START PAGE** screen key on the 'PAGE SETUP' screen. This transfers to the 'Current start page' screen:

Configuration	
The current start page is 1	
Enter a new page :	
TODAY'S DATE      TIME	
EXIT	

2. Use Direct edit to enter the new start page number.
3. Press the ↵ screen key to confirm the new page number and return to the 'PAGE SETUP' menu screen. The new page number will appear on the 'Present settings' list.
4. The **EXIT** screen key reverts to the PAGE SETUP screen without changing the start page number.

### 3.4.3.23 Page length, header and footer sizes

'Page length', 'Header size' and 'Footer size' are changed by similar operations as for the 'Start page number' change. No further explanation is necessary.

After all the page setup characteristics are satisfactory, press EXIT on the 'PAGE SETUP' screen to return to the 'CERT DETAILS' screen.

### 3.4.3.24 'Pass indicator'

On the 'CERT DETAILS' screen, the 'PASS INDIC' soft key acts as a toggle to turn the pass indicator facility off and on. There is no transfer to another screen, The state of the pass indicator on the 'CERT DETAILS' screen merely toggles between off and on as the facility is altered.

### 3.4.3.25 'Appended message'

#### Message required for the Certificate

For the printed results certificates, users may wish to add a descriptive message.

1. To access the message screen, press the **APPEND MESSAGE** screen key on the 'CERT DETAILS' screen. This transfers to the 'Current appended message' screen:
2. Use Direct edit to enter the new message.

Configuration	
The current appended message is: <i>(The current message appears in this space)</i>	
Enter a new message:	
TODAY'S DATE	TIME
EXIT	

3. Press the  $\downarrow$  screen key to return to the 'CERT DETAILS' screen. The message appears on the 'Present settings' list.
4. The **EXIT** screen key reverts to the CERT DETAILS screen without changing the appended message.

### 3.4.3.26 'LAB DETAILS'

#### Laboratory Details required for the Certificate

For the printed results certificates, it is required to enter details of the laboratory at which the results were obtained.

Users should enter the name, temperature and relative humidity of their laboratory for the printed certificates.

1. To set up the Laboratory details, press the **LAB DETAILS** screen key on the 'CERT DETAILS' screen.  
This transfers to what we shall refer to as a 'LAB DETAILS' screen:
2. The lab name, temperature and humidity

Configuration		LAB NAME
Present Settings:		LAB TEMP
Lab name	Fluke L...	LAB HUMID
Lab temp.	23°C ±5°C	
Lab humid.	40% ±10%	
TODAY'S DATE	TIME	
EXIT		

#### LAB DETAILS Screen Layout

can be entered via the three screen keys on the right.

3. The **EXIT** key reverts to the CERT DETAILS screen.

### 3.4.3.27 'LAB NAME'

1. To enter the Laboratory name, press the **LAB NAME** screen key on the 'LAB DETAILS' screen. This transfers to the 'Current lab name' screen:

Configuration	
The current lab name is: <i>(The current name appears in this space)</i>	
Enter a new name:	
TODAY'S DATE	TIME
EXIT	

2. Use Direct edit to enter the new laboratory name.
3. Press the  $\downarrow$  screen key to return to the 'LAB DETAILS' screen: The new lab name will appear on the 'Present settings' list.
4. The **EXIT** screen key reverts to the LAB DETAILS screen without changing the lab name.

### 3.4.3.28 Laboratory Temperature and Humidity

'Lab temp' and 'Lab humid' are changed by similar operations as for the 'Lab name' change. No further explanation is necessary.

After all the laboratory details are satisfactory, press EXIT on the 'LAB DETAILS' screen to return to the 'CERT DETAILS' screen.

### 3.4.3.29 'CLEAR USER LIST'

#### Procedure Mode User List

A list of users is presented on the opening menu screen of Procedure mode, where the user's name can be selected to appear on the certificate. New names can be added to the screen at the same time.

Names cannot be removed from the list without knowing the Config mode password, which must be used to access the 'Clear user list' facility.

1. For access to allow the Procedure mode user list to be cleared, press the **CLEAR USER LIST** screen key on the second 'Present Settings' screen. This transfers to the confirmation screen:

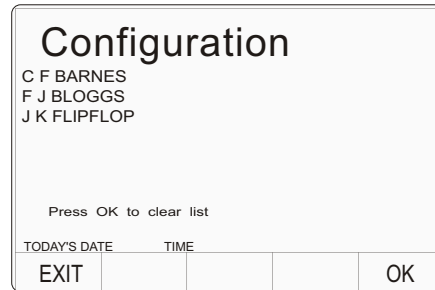

3. **OK** removes all names from the list and returns to the second 'Present Settings' menu screen.
4. **EXIT** returns to the second 'Present Settings' menu screen without removing the names.

Final Width = 215mm

### Sec 3.4.3.30 \*IDN? CONFIG

To retain compatibility with software applications that depend upon instrument response to the IEEE 488.2 common command \*IDN? it may be necessary to configure your "Fluke 9500B" to respond as a previous model "9500" from a previous manufacturer E.g. "Wavetek".

1. On the second "Present Settings" menu screen, press the IDN screen key on the bottom row of Softkeys. This transfers to the "\*IDN? Config" screen:

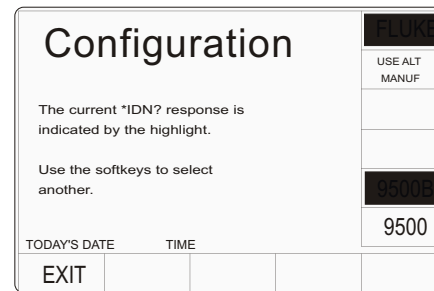
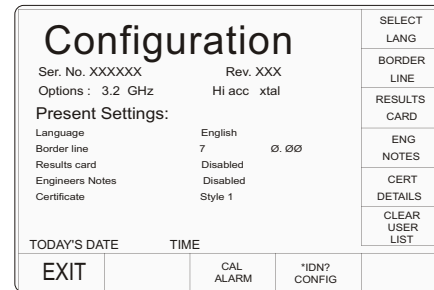

2. The EXIT screen key reverts to the second "Present Settings" menu screen.

### Sec 3.4.3.31 'CAL Alarms'

The default setting for calibration alarms is enabled. This configuration allows these alarms to be disabled.

1. On the second "Present Settings" menu screen, press the CAL Alarm key on the bottom row of Softkeys. This transfers to the "CAL Alarm" screen:

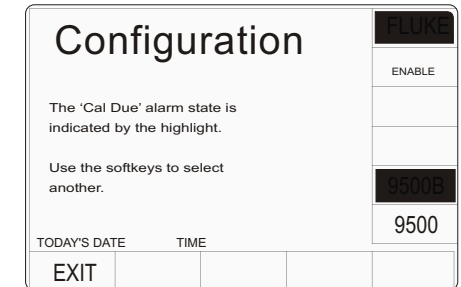
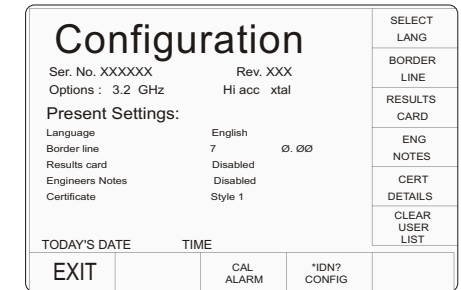

2. The EXIT screen key reverts to the second "Present Settings" menu screen.

# Section 4 Using the Model 9500B — Manual Mode

## 4.1 About Section 4

Section 4 is divided into the following sub-sections:

	page		page		page
4.1 About Section 4		4.8 Time Markers Function		4.13 Overload Pulse Function	
4.2 Interconnections		4.8.1 Introduction	4.8-1	4.13.1 Introduction	4.13-1
4.2.1 Introduction	4.2-1	4.8.2 Default Settings	4.8-1	4.13.2 Overload Protection Test	4.13-1
4.2.2 Active Head Technology™	4.2-1	4.8.3 Menu Selections	4.8-1	4.13.3 Default Settings	4.13-1
4.2.3 AUX IN	4.2-2	4.8.4 Time Markers Operation	4.8-2	4.13.4 Menu Selections	4.13-1
4.2.4 REF FREQUENCY INPUT	4.2-2	4.8.5 Using the 9500B Time Markers Function to Calibrate the Time Base of a UUT Oscilloscope	4.8-4	4.13.5 Overload Pulse Operation	4.13-1
4.2.5 REF FREQUENCY OUTPUT	4.2-2			4.13.6 Using the 9500B to Test the Overload Response of a UUT Oscilloscope	4.13-2
4.3 Manual Mode - Function Selection		4.9 Auxiliary Functions		4.14 Zero Skew Function	
4.3.1 Introduction	4.3-1	4.9.1 Introduction	4.9-1	4.14.1 Introduction	4.14-1
4.3.2 Selection of Manual Mode	4.3-1	4.9.2 Selection of Auxiliary Functions	4.9-1	4.14.2 Default Settings	4.14-1
4.3.3 Front Panel Function Keys	4.3-1			4.14.3 Menu Selections	4.14-1
4.4 Edit Facilities		4.10 Current Function		4.14.4 Zero Skew Operation	4.14-2
4.4.1 Introduction	4.4-1	4.10.1 Introduction	4.10-1	4.14.5 Measurement of UUT Oscilloscope Channel Skew	4.14-3
4.4.2 Direct Mode	4.4-1	4.10.2 Current Probe Accessory	4.10-1		
4.4.3 Scope Mode	4.4-4	4.10.3 Default Settings	4.10-1	4.15 Auxiliary Input	
4.5 DC/Square Function		4.10.4 Menu Selections	4.10-2	4.15.1 Introduction	4.15-1
4.5.1 Introduction	4.5-1	4.10.5 Current Operation	4.10-2	4.15.2 Automated Routing	4.15-1
4.5.2 Default Settings	4.5-1	4.10.6 Square Operation	4.10-3	4.15.3 Default Settings	4.15-1
4.5.3 Menu Selections	4.5-1	4.10.7 Using the 9500B Current (Square) Function to Calibrate the Pulse Response of a UUT Oscilloscope Current Probe	4.10-4	4.15.4 Menu Selections	4.15-1
4.5.4 DC/Square Operation	4.5-4	4.10.8 DCI Operation	4.10-5	4.15.5 Auxiliary Input Operation	4.15-1
4.5.5 Square Operation	4.5-4	4.10.9 Using the 9500B DCI Function to Calibrate the Amplitude Response of a UUT Oscilloscope Current Probe	4.10-6	4.15.6 Using the 9500B for Automated Routing of User-Specific Calibration Signals to UUT Oscilloscope Input Channels	4.15-2
4.5.6 Using the 9500B Square Function to Calibrate the Amplitude Response of a UUT Oscilloscope	4.5-6				
4.5.7 DC Operation	4.5-8	4.11 Composite Video Function		4.16 Load Resistance and Capacitance Measurement	
4.5.8 Using the 9500B DC Function to Calibrate the Amplitude Response of a UUT Oscilloscope	4.5-9	4.11.1 Introduction	4.11-1	4.16.1 Introduction	4.16-1
4.6 Sine Function		4.11.2 Signals and Triggers	4.11-1	4.16.2 Measurement Method	4.16-1
4.6.1 Introduction	4.6-1	4.11.3 Default Settings	4.11-1	4.16.3 Default Settings	4.16-1
4.6.2 Default Settings	4.6-1	4.11.4 Menu Selections	4.11-1	4.16.4 Menu Selections	4.16-1
4.6.3 Menu Selections	4.6-1	4.11.5 Composite Video Function Operation	4.11-2	4.16.5 Measurement Operation	4.16-1
4.6.4 Sinewave Operation	4.6-2	4.11.6 Using the Composite Video Function to Calibrate Video Trigger Sensitivity of a UUT Oscilloscope	4.11-2	4.16.6 Use the 9500B to Measure Load Resistance or Load Capacitance	4.16-2
4.6.5 Dual Channel Operation	4.6-4				
4.6.6 Using the 9500B Levelled Sine Function to Calibrate the Flatness/Bandwidth Response of a UUT Oscilloscope	4.6-5	4.12 Linear Ramp Function		4.17 Input Leakage Function	
4.7 Edge Function		4.12.1 Introduction	4.12-1	4.17.1 Introduction	4.17-1
4.7.1 Introduction	4.7-1	4.12.2 Default Settings	4.12-1	4.17.2 Input Leakage Test	4.17-1
4.7.2 Default Settings	4.7-1	4.12.3 Menu Selections	4.12-1	4.17.3 Default Settings	4.17-1
4.7.3 Menu Selections	4.7-1	4.12.4 Linear Ramp Operation	4.12-1	4.17.4 Menu Selections	4.17-1
4.7.4 Edge Function Operation	4.7-2	4.12.5 Using the 9500B Linear Ramp Function for Error Code Detection and Trigger Level Marker Checks	4.12-2	4.17.5 Input Leakage Operation	4.17-1
4.7.5 Using Active Head Models 9510/9520/9530	4.7-3			4.17.6 Using the 9500B to Test the Input Leakage Current of a UUT Oscilloscope	4.17-2
4.7.6 Using the 9500B Edge Function to Calibrate the Pulse Response of a UUT Oscilloscope	4.7-4			4.18 Pulse Width Function	
				4.18.1 Introduction	4.18-1
				4.18.2 Trigger Qualification Timer Tests	4.18-1
				4.18.3 Default Settings	4.18-1
				4.18.4 Menu Selections	4.18-1
				4.18.5 Pulse Width Operations	4.18-1

*Final Width = 215mm*

BLANK PAGE (LEFT-HAND)

## 4.2 Interconnections

### 4.2.1 Introduction

This sub-section deals with the Active Head Technology™ used to connect the 9500B to a UUT oscilloscope, and rear-panel signal inputs and outputs. Section 4.2 is divided into the following sub-sections:

	<i>page</i>
4.2.1 Introduction	4.2-1
4.2.2 Active Head Technology™	4.2-1
4.2.2.1 Connections to the 9500B and UUT Oscilloscope	4.2-1
4.2.2.2 Head Module Signal Processing	4.2-1
4.2.3 AUX IN (Rear Panel)	4.2-2
4.2.4 REF FREQUENCY INPUT	4.2-2
4.2.5 REF FREQUENCY OUTPUT	4.2-2
4.2.6 Single and Multiple Channel Outputs	4.2-2
4.2.6.1 Single-Channel Variants	4.2-2
4.2.6.2 Option 5	4.2-2

### 4.2.2 Active Head Technology

The main function of a head is to route the 9500B's output to the UUT oscilloscope input channel without intervening cables that could degrade the signal.

Each head contains output circuitry that generates and supports the transmission of pulses of very short rise and fall times with low distortion, and amplitude variable from  $\pm 5\text{mV}$  to  $\pm 3\text{V}$ , and good  $50\Omega$  matching. This is achieved by the use of low-loss substrate dielectrics, with wide-band components, attenuators and relays. The heads also perform the function of sinewave levelling.

Available head modules include:

- **Model 9510** — 1.1GHz Output Module with 500ps pulse edge capability.
- **Model 9530** — 3.2GHz Output Module with 150ps and 500ps pulse edge capability.
- **Model 9550** — Output Module with 25ps pulse edge capability only.
- **Model 9560** — 6.4GHz Output Module with 70ps pulse edge capability.

Electrical specifications apart, modules are interchangeable. The 9500B accepts any mix of types, up to five modules.

#### 4.2.2.1 Connections to the 9500B and UUT Oscilloscope

Two connections are used for each head. An 18-way connector and cable provides power supplies, control and sense signals, whereas a separate coaxial connector and cable carries the signal or clock. The output signal is delivered directly to the UUT oscilloscope's input channel through the single BNC or PC3.5 connection.

















#### Caution:

The  symbol, shown on the 9500B front panel and heads, draws attention to information contained in this handbook regarding maximum output voltages and currents.

For details, refer to *Section 7: Specifications*.

#### 4.2.2.2 Head Signal Processing

Signal processing in the head modules can be summarized by considering the 9500B functions:

-  **DC/Square**. The signal is routed directly via switched attenuators to the output BNC or PC3.5 socket. Sensing from the output is passed back to the mainframe, effectively providing a 4-wire delivery.
  -  **Sine**. The sinewave at its final frequency is passed through the input SMA coaxial cable. Sinewave amplitude is set in the mainframe, but sensing for sinewave levelling takes place in the head itself, returning the levelling control signal to the mainframe. The levelled signal is routed via attenuators to the output BNC or PC3.5 socket.
  -  **Edge**. Pulse levels and timing originate in the mainframe and pass to the head for control of the edge generating circuitry. Pulses with 500ps edge are routed via the LF/DC attenuators to the output BNC or PC3.5 socket (Models 9510/9530). Special attenuators in Model 9530/9560 are used for the 150ps or 70ps edge pulses.
-  **Markers**. Marker types:  Square/Sine,  Pulses or  Narrow Triangle waveform), timing and levels originate in the mainframe and pass directly via switched attenuators to the output BNC or PC3.5 socket. Line frequency markers are also included.
  - Aux**.
    -  **ADC/Square Current Source**. Current outputs between  $100\mu\text{A}$  and  $100\text{mA}$  are derived from the DC/Square voltage source via an external BNC current loop accessory ( $50\Omega$  load to 9500B output). The output calibrates current probes. NB. Not compatible with 9550 or 9560.
    -  **Composite Video**. Video voltage outputs are passed directly via the output BNC or PC3.5 to test TV sync separator functions.
    -  **Linear Ramp**. Symmetrical triangular  $1\text{Vp-p}$  waveforms of period 3ms to 3s are passed via the DC/Square voltage route to the output BNC or PC3.5. These calibrate trigger level markers and check DSOs for missing ADC codes.
    -  **Overload Pulse**. High energy pulses between 5V and 20V of limited duration are passed via the DC/Square voltage route to the output BNC or PC3.5, to test  $50\Omega$  terminator protection.
    -  **Zero Skew**. Permits 9500B channels/heads transit times to be harmonized, in order to test UUT input channel trigger synchronization.
    -  **AUX IN**. Routes external calibration waveforms to an active head's BNC or PC3.5 output.
    -  **Load Resistance**. Measures load resistance in the active head's output circuit.
    -  **Load Capacitance**. Measures load capacitance in the active head's output circuit.
    -  **UUT Input Leakage Tests**. Short/Open-circuit outputs directly to the output BNC or PC3.5 allow testing of oscilloscope input leakage current.

*continued overleaf* →

*Final Width = 215mm*

*Final Width = 215mm*

---

### **4.2.3 AUX IN (Rear Panel)**

Despite the huge flexibility of the 9500B, it is sometimes desirable to apply signals from user's equipment to the inputs of a UUT oscilloscope, for specific calibration or test purposes.

With the 9500B Auxiliary Input selected, wideband passive routing is available from a rear-panel 50Ω SMA input through to the selected 9500B channel output, using 9500B front panel controls.

No trigger pickoff is provided, and internal triggers are not available.

### **4.2.4 REF FREQUENCY INPUT**

A BNC connector on the 9500B rear panel accepts reference frequency inputs from 1MHz to 20MHz in 1MHz steps, from a TTL source, to enhance the 9500B internal clock.

### **4.2.5 REF FREQUENCY OUTPUT**

A BNC connector on the 9500B rear panel provides a reference frequency output at either 1MHz or 10MHz, from a 50Ω source (VSWR < 1.2 to 100MHz). This can use the 9500B internal clock to enhance the frequency accuracy of other devices.



## 4.3 Manual Mode — Function Selection

### 4.3.1 Introduction

This sub-section is a guide to selecting the functions in Manual mode. The following topics are covered:

4.3.1	Introduction .....	4.3-1
4.3.2	Selection of Manual Mode .....	4.3-1
4.3.3	Front Panel Function Keys .....	4.3-1
4.3.3.1	'Function' Keys .....	4.3-1
4.3.3.2	Default Settings .....	4.3-1
4.3.3.3	'OSCILLOSCOPE CALIBRATOR' Panel - Right Side Keys select Functions ...	4.3-1

### 4.3.2 Selection of Manual Mode

Whenever the 9500B is in another mode, Manual mode can be selected by pressing the front panel **Mode** key, followed by the **Manual** screen key at the left of the bottom row.

(N.B. The 9500B can be made to default to either Manual or Procedure mode at power-up (refer to para 3.4.3.6: 'Power-up mode').

### 4.3.3 Front Panel Function Keys

N.B. This description assumes that the 9500B is powered-up and that Manual mode is active.



Fig. 4.3.3.1 9500B Function Keys

#### 4.3.3.1 'Function' Keys

A function is accessed by pressing one of five keys at the right of the 'OSCILLOSCOPE CALIBRATOR' panel, as highlighted in Fig. 4.3.3.1.

#### 4.3.3.2 Default Settings

When entering Manual mode, the system selects DC/Square function. The system defaults to show the DC/Square menu screen:

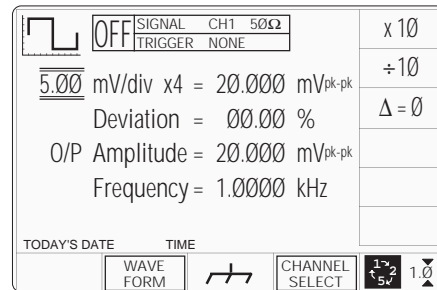



Fig. 4.3.3.2 Manual Mode Power-Up Screen — Multi-Channel

#### 4.3.3.3 'OSCILLOSCOPE CALIBRATOR' Panel — Right Side Function Keys

This panel carries the main controls used to select the operational functions and modes of the calibrator:

**Manual and Calibration Mode Function keys** are arranged down the right edge:

 : DC/Square function. Select Square with direction, or  $\pm$ DCV using screen keys. Select output channel, amplitudes and frequency using screen keys and cursor controls.

 : Levelled Sinewave function. Select output channel, amplitude and frequency using screen keys and cursor controls.

 : Edge. Select polarity, amplitude and frequency using screen keys.

 : Timing Markers. Select Waveform, Amplitude and Frequency/Period, using screen keys.

**Aux** : Auxiliary Functions. Select from

- Current,
- Composite Video,
- Linear Ramp,
- Overload Pulse,
- Zero Skew,
- Auxiliary Input,
- Load Resistance or Load Capacitance measurement,
- UUT Input Leakage Test using screen keys,
- Pulse Width.

As soon as a right-side screen key is pressed (other than ) the default menu screen will disappear, to be replaced by the default screen of the selected oscilloscope function.

For further details refer to subjects later in this section.

Final Width = 215mm

---

*Final Width = 215mm*  
PAGE LEFT BLANK

## 4.4 Edit Facilities

### 4.4.1 Introduction

#### 4.4.1.1 Subject Contents

Sub-section 4.4 is divided into the following paragraphs:



	Page
4.4.1 Introduction .....	4.4-1
4.4.1.1 Subject Contents .....	4.4-1
4.4.1.2 Methods of Adjustment .....	4.4-1
4.4.1.3 Adjustment Modes .....	4.4-1
4.4.1.4 Use of the Tab Key .....	4.4-1
4.4.1.5 Scope Mode is the Default .....	4.4-1
4.4.2 Direct Mode .....	4.4-1
4.4.2.1 Introduction .....	4.4-1
4.4.2.2 Cursor Control .....	4.4-1
4.4.2.3 Direct Mode - Digit Edit .....	4.4-2
4.4.2.4 Direct Mode - Numeric Entry .....	4.4-2
4.4.2.5 Return to Scope Mode .....	4.4-3
4.4.3 Scope Mode .....	4.4-4
4.4.3.1 Introduction .....	4.4-4
4.4.3.2 Cursor Controls .....	4.4-4
4.4.3.3 Use of Sequence Scroll .....	4.4-4

#### 4.4.1.2 Methods of Adjustment

Before looking at displays for the functions, we need to know how to alter the values displayed on the screen. There are three main methods used to change values:

- 'Digit Edit'; in which values can be scrolled digit by digit, using a 'triangular' cursor and associated controls.
- 'Sequence Scroll'; in which values can only be changed by scrolling through a sequence of values, using a 'barred' cursor and associated controls. One of two common sequences can be selected using the 'Pref' facility.
- 'Numeric Entry Edit'; where a complete new value is written in place of the existing selected value, using the 'triangular' cursor and the numeric keypad.

#### 4.4.1.3 Adjustment Modes

In addition to the three methods, there are two modes, selected by the right-most soft key on the bottom row beneath the screen, which toggles between 'Scope' mode  and 'Direct' mode . These are not major modes of the same magnitude as Manual mode, but identify specific means of making selections or entering changes on the screen.

1. 'Scope Mode'; which relates to the way that oscilloscopes are ranged in sequences. Scope mode mainly uses Sequence Scroll, but also includes limited use of Digit Edit and Numeric Entry Edit. This is indicated by the bottom right corner key label: .

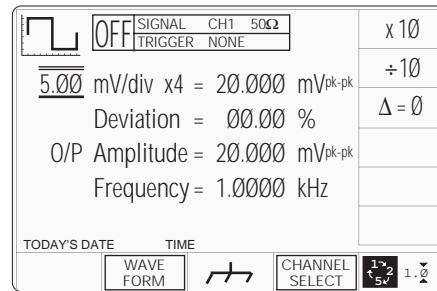



Fig. 4.4.1 Typical Screen in Scope Mode

2. 'Direct Mode'; which permits access to all contributing parameters using only Digit Edit and Numeric Entry Edit, indicated by the bottom right corner key label: .

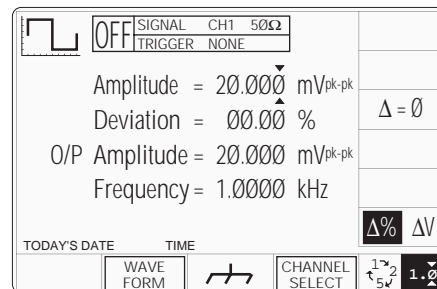



Fig. 4.4.2 Typical Screen in Direct Mode

#### 4.4.1.4 Use of the Tab Key

In all editing, the **Tab key**  is used to select the required variable for adjustment.

#### 4.4.1.5 Scope Mode is the Default

Scope Mode is the default mode, which will always be forced at power-on and when changing modes. However, we shall discuss Direct mode first because Sequence Scroll is excluded.

In order to enter Direct mode, the bottom right-most soft key must be toggled so that its label changes to: .

### 4.4.2 Direct Mode

#### 4.4.2.1 Introduction

In Direct mode, once the  key has selected the required variable, the cursor can take only one form: 'triangular'. A pair of triangles, pointing at a single digit, indicate that the digit's value can be scrolled continuously in integer increments.

Note that the Units/division and multiplier fields are not used, and the 'barred' cursor seen on the default screen is missing.

#### 4.4.2.2 Cursor Control

The cursor controls used in Direct mode are shown highlighted in Fig. 4.4.3.



continued overleaf →

*Final Width = 215mm*

Final Width = 215mm

#### 4.4.2 Direct Mode (Contd.)

##### 4.4.2.3 Direct Mode — Digit Edit

With the triangular cursor attached to a digit, the  $\uparrow/\downarrow$  keys and the spinwheel are used to increase or decrease the digit's value. The  $\leftarrow$  and  $\rightarrow$  keys move the cursor along the number to select the digit to be scrolled. Except for Deviation, where the resolution cannot be changed, movement of the cursor off the end of the number will cause the resolution to change to accommodate an extra digit, until no further resolution change is possible.

The two shift keys  $\blacktriangle$  or  $\blacksquare$  can be used as a short cut to change the number's resolution. Pressing either of the shift keys before a  $\leftarrow$  or  $\rightarrow$  key will effect the change, even if the digit may not be at the end of the number. The cursor will remain with its selected digit.

Note that after pressing a shift key, its image appears and remains on the bottom right of the screen until the  $\leftarrow$  or  $\rightarrow$  key is pressed. (for Deviation, the resolution cannot be changed, so use of a shift key is ineffective.)

##### 4.4.2.4 Direct Mode — Numeric Entry Introduction

Numeric Entry is not a default state. *Digit Edit* will always be forced at power-on, and when changing modes and functions.

Each method has its own advantages, which will become apparent with experience of using the front panel controls.

Numeric Entry facility employs the numeric keypad to enter whole values, where this is more convenient than operating on individual digits in 'Digit Edit' facility.

##### Cursor Control

The tab  $\rightarrow$  key is used to pass the cursor from one parameter to another, but the  $\uparrow$ ,  $\downarrow$ ,  $\leftarrow$ ,  $\rightarrow$  keys and spinwheel play no part in setting the value.

##### Form of Cursor

Numeric Entry can be used to alter only those parameter values which are accessed by the *triangular* form of cursor. The cursor can sit on any digit in the number, and Numeric Entry will have the same effect.

##### Value Editing

The controls for Numeric Entry to alter the value are the numeric keys of the alpha numeric keypad, highlighted in Fig. 4.4.4.

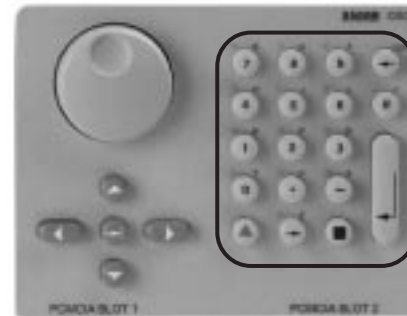

##### Value Entry Box

Once a numeric key is pressed, an enclosed area (box) will be provided on the screen, below a reduced-size version of the value to be changed. The box can be seen in Fig. 4.4.6.

##### Numeric Entry Action

Assume that the tab key has placed the cursor on the Deviation value, in this case 00.00%. The cursor can be seen in Fig. 4.4.5.

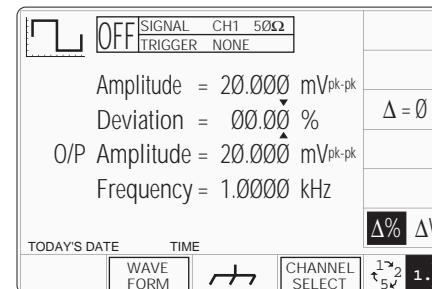

Fig. 4.4.5 Numeric Entry Starting Point

By typing the number '10' (for +10%) on the numeric keypad, the value entry box appears on the display as shown in Fig. 4.4.6.

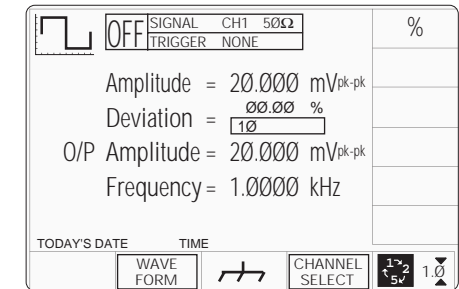

Fig. 4.4.6 Numeric Entry — Effect on Deviation Value and Screen Key Labels

The new value is implemented by pressing the  $\downarrow$  (Enter) key on the keypad, or '%' at the top of the right screen keys. The display then changes to that shown in Fig. 4.4.7.

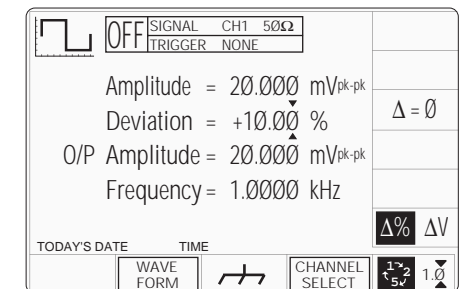
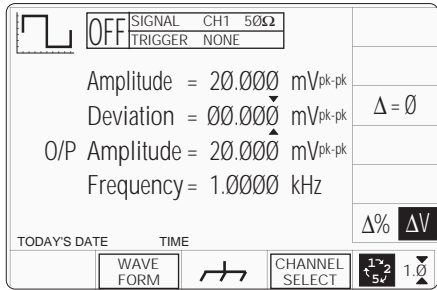

Fig. 4.4.7 Result of Pressing  $\downarrow$  (Enter)

Note that the 9500B has assumed that the typed characters '10' represent a deviation of +10.00% in this context. For a deviation of -10.00%, type the characters '-10' using the keypad hyphen as a negative symbol.

##### Parameter Context

If the Deviation units had been changed to ΔV (absolute voltage) instead of the relative Δ%, then instead of Fig. 4.4.5, this would be indicated as shown in Fig. 4.4.8



**Fig. 4.4.8 Deviation Selected as ΔV**

In this case by typing the number '.002', the 9500B respects this change of units. The result is shown in Fig. 4.4.9, also changing the available unit labels on the right screen keys to reflect the change.

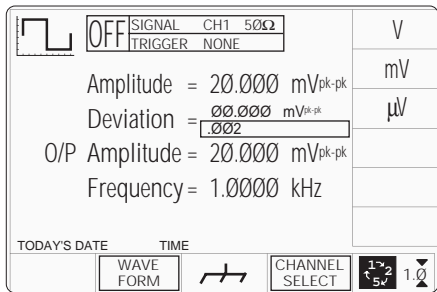

**Fig. 4.4.9 Option to Choose Units for Deviation Value**

Note that if the new value is implemented by pressing the ↵ (Enter) key on the keypad, then (in this case) the units will be Volts. If the number '2' had been typed followed by ↵, an error message would have appeared, as 2V is obviously outside the deviation range of ±10% for the set value of 20mV. This could have been avoided by typing '2', then pressing the 'mV' screen key to obtain the correct result (Fig.4.4.10):

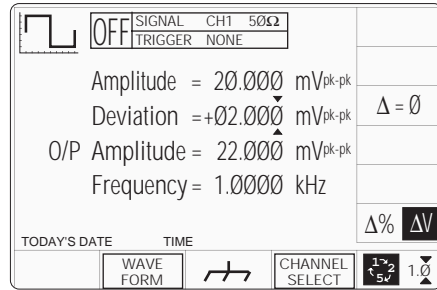

**Fig. 4.4.10 Voltage Deviation Applied**

The new deviation of +2mV is equivalent to +10% of the set value, which can be seen by pressing the right side key Δ%/ΔV.

#### Numeric Entry Result

The 9500B will comply with the instructions given in Numeric Entry, using the displayed value to set the output deviation, in the same way as for Digit Edit. This applies wherever it is possible to use Numeric Entry.

#### 4.4.2.5 Return to Scope Mode

The 9500B will always permit return from Direct mode to Scope mode, even if the values on the screen cannot be attained in Scope mode. The values will default to extremes if necessary. For example:

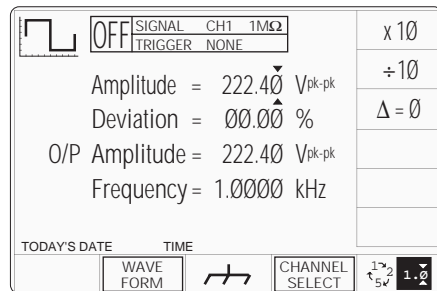

**Fig. 4.4.11 Direct Mode Starting Point**

In Fig. 4.4.11, the (maximum) O/P Amplitude has been set using Direct mode (as shown). An error message will result for any attempt to increase the Amplitude value or any positive Deviation percentage.

If the bottom right screen key (Editing Mode key) is pressed to return to Scope mode, the two contributors (Units/Div and Deviation) will be adjusted to achieve the same O/P Amplitude, as shown in Fig 4.4.12:

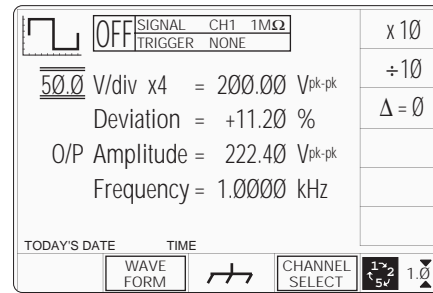

**Fig. 4.4.12 Transfer to Scope Mode**

For simplicity, the remainder of Manual mode is described in this handbook in terms of Scope mode, Digit Edit.

*continued overleaf →*

*Final Width = 215mm*

Final Width = 215mm

### 4.4.3 Scope Mode

#### 4.4.3.1 Introduction

In Scope mode, once the  $\rightarrow$  key has selected the required variable, the cursor can take one of two forms: 'triangular' and 'barred'. The triangular form operates in the same way as in Direct mode, and permits editing using Numeric Entry as well as Digit Edit.

Note that the Units/Division and Multiplier fields are used in Scope mode, corresponding to similar arrangements in UUT oscilloscopes.

#### 4.4.3.2 Cursor Controls

##### Triangular Cursor

For the triangular cursor, the main controls used to manipulate the cursor are the same as for Direct mode, except that the two keypad shift keys have no effect, as the only variable which uses the triangular cursor is 'Deviation', whose resolution is constant.

##### 'Barred' Cursor

Two pairs of horizontal lines, enclosing a value, indicate that for that value, neither Digit Edit nor Numeric Entry is available. The value can be adjusted only within a preferred step sequence. Numeric Entry editing is not available for numbers with a 'Barred' cursor:

$\overline{5.00}$  mV/div x4 = 20.000 mV<sub>pk-pk</sub>

With this form of cursor, the  $\leftarrow$  and  $\rightarrow$  keys are inactive. The  $\uparrow$  /  $\downarrow$  keys and the spinwheel increase or decrease the whole value, using the preferred sequence for that parameter (refer to Section 3, subsection 3.3). The controls used for the barred cursor are highlighted in Fig. 4.4.13:

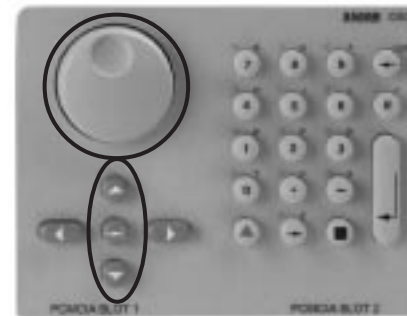

Fig. 4.4.13 Barred Cursor Control Keys

#### 4.4.3.3 Use of Sequence Scroll

Having already dealt with Digit Edit, Sequence Scroll is easy to understand. The default DC/Square screen of Fig. 4.4.1 is repeated in Fig 4.4.14 as an example:

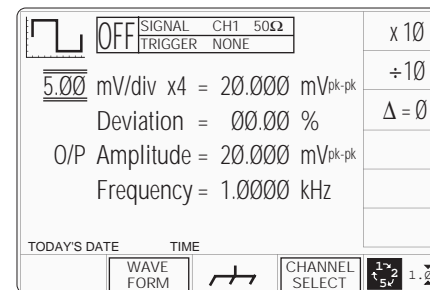

Fig. 4.4.14 DC/Square Default Screen

Using the Tab  $\rightarrow$  key to transfer through the four available fields in turn, it can be seen that the 'mV/div', the Multiplier and the Frequency fields use barred cursors, with the Deviation field using a triangular cursor.

Returning to the mV/div field, pressing the  $\uparrow$  key will increase the whole value to 10.0mV, or pressing the  $\downarrow$  key will reduce the whole value to 2.00mV (always assuming that the sequence 1 $\rightarrow$ 2 $\rightarrow$ 5 has been selected in 'Pref' facility). All other values with barred cursors will also be incremented in the preferred sequence.

## 4.5 DC/Square Function

### 4.5.1 Introduction

This sub-section is a guide to the use of the 9500B for generating square waves and DC voltages for use for amplitude calibration of oscilloscopes.

For those users who require more detailed instructions for interconnections, and manipulating the front panel controls, refer to *sub-sections 4.2, 4.3 and 4.4*. Section 4.5 is divided into the following sub-sections:

4.5.1	Introduction .....	4.5-1
4.5.2	Default Settings .....	4.5-1
4.5.3	Menu Selections .....	4.5-1
4.5.3.1	Signal Channels .....	4.5-1
4.5.3.2	UUT Triggers .....	4.5-2
4.5.3.3	Trigger Channel Selection .....	4.5-2
4.5.3.4	Cable Selection .....	4.5-2
4.5.3.5	Trigger Ratio .....	4.5-3
4.5.3.6	Retained Channel Memory .....	4.5-3
4.5.3.7	Choosing a Waveshape .....	4.5-3
4.5.3.8	DC Selection .....	4.5-3
4.5.3.9	DC/Square Selection Summary .....	4.5-3
4.5.4	DC/Square Operation .....	4.5-4
4.5.4.1	Right Side Screen Keys - Digit Edit/ Sequence Scroll .....	4.5-4
4.5.4.2	Right Side Screen Keys - Numeric Entry .....	4.5-4
4.5.4.3	Bottom Screen Keys - Digit Edit, Sequence Scroll and Numeric Entry .....	4.5-4
4.5.5	Square Operation .....	4.5-4
4.5.5.1	Value Editing .....	4.5-4
4.5.5.2	Output Voltage Editing .....	4.5-5
4.5.5.3	Low Voltage (LV) and High Voltage (HV) States .....	4.5-5
4.5.6	Using the 9500B Square Function to Calibrate the Amplitude Response of a UUT Oscilloscope ...	4.5-6
4.5.6.1	Introduction .....	4.5-6
4.5.6.2	Interconnections .....	4.5-6
4.5.6.3	UUT Scope - Amplitude Calibration using the 9500B as a Fixed Source .....	4.5-6
4.5.6.4	UUT Scope - Amplitude Calibration using the 9500B as an Adjustable Source .....	4.5-7
4.5.7	DC Operation .....	4.5-8
4.5.7.1	Polarity .....	4.5-8
4.5.7.2	Value Editing .....	4.5-8
4.5.7.3	Output Voltage Editing .....	4.5-8
4.5.7.4	Low Voltage (LV) and High Voltage (HV) States .....	4.5-8
4.5.7.5	Multi Channel DC Operation .....	4.5-8
4.5.8	Using the 9500B DC Function to Calibrate the Amplitude Response of a UUT Oscilloscope ...	4.5-9
4.5.8.1	Introduction .....	4.5-9
4.5.8.2	Interconnections .....	4.5-9
4.5.8.3	UUT Scope — Amplitude Calibration using the 9500B as a Fixed Source of DC Voltage .....	4.5-9
4.5.8.4	UUT Scope — Amplitude Calibration using the 9500B as an Adjustable Source of DC Voltage .....	4.5-10

### 4.5.2 Default Settings

When Manual mode is selected the system defaults into DC/Square function and shows the DC/Square function initial menu screen. Otherwise, the function is accessed by pressing the  function key at the top right of the 'OSCILLOSCOPE CALIBRATOR' panel.

Whenever the DC/Square menu screen is opened, except on recovery from a standby period, it may appear with the following default settings, although some settings may have been made non-volatile (*refer to para 4.5.3.6*):

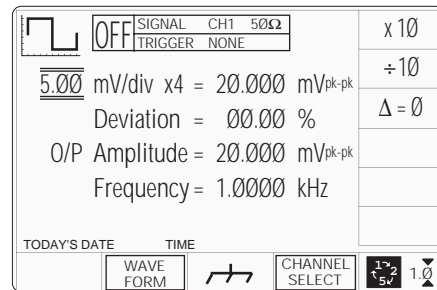

The above default screen has auto-selected the positive square waveform, as indicated by the icon in the top left corner. Frequency is variable between 10.000Hz and 100.00kHz. Frequency has defaulted to 1kHz, deviation 'Δ' to zero, and output voltage to 20.000mVp-p. The Duty Cycle is fixed at a nominal 50%.

### 4.5.3 Menu Selections

#### 4.5.3.1 Signal Channels

Each channel leads to specified pair of active head connectors, and a head (if fitted). The required channel can be selected on a second menu screen. This is activated by pressing the 'CHANNEL SELECT' screen key on the bottom row. The screen changes to show the available channels (the presence of a head is detected when fitted):

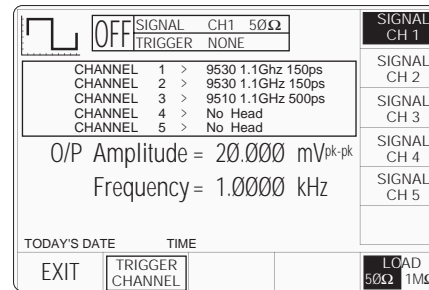

As can be seen from the screen, Model 9530 heads are fitted to channels 1 and 2, a Model 9510 head is fitted to channel 3, and no heads are fitted to channels 4 and 5.

The highlight on channel 1 indicates that this channel is selected for signal output, (confirmed by the legend in the top central box). Pressing any one of the right side soft keys selects that channel for the signal output.

Expected load is confirmed as 50Ω (once selected, the selection applies to all signal channels). The right-most key on the bottom row toggles between expected loads of 50Ω and 1MΩ. The presence of 'TRIGGER NONE' in the top central box indicates that no trigger channel has been nominated.

Pressing the 'EXIT' key will revert back to the standard DC/Square screen of *para 4.5.2*.

#### Note:

When a channel's head is finally connected to the UUT oscilloscope, and the 9500B output is turned on, the 9500B will measure the UUT load. If the measured load is outside the specification for the expected load, then an error message will appear on the screen:

'Load Mismatch Detected UUT >150Ω' for 50Ω selected;

'Load Mismatch Detected UUT <50kΩ' for 1MΩ selected.

*continued overleaf →*

*Final Width = 215mm*

Final Width = 215mm

#### 4.5.3.2 UUT Triggers

The trigger can be routed via any head (except 9550), but a standard SMA to BNC coaxial cable can be used instead, to save the cost of an extra head. The reason for establishing five channels is to permit use of four signal heads to carry a full range of signals, plus an extra channel to accommodate the trigger input, if necessary. When a cable is fitted instead of a head, it cannot carry the full range of signals. Pressing the **'TRIGGER CHANNEL'** soft key provides a screen which permits a user to assign a channel to trigger outputs:

As the screen shows, as yet no channel has

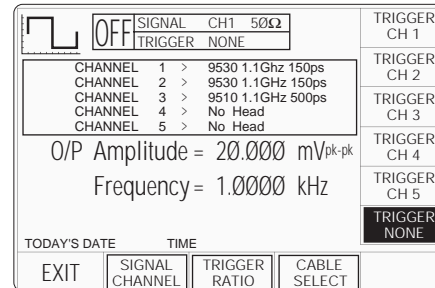

been allocated to triggers. This is confirmed by the legend in the top central box and the right side screen keys.

On the screen, the **'TRIGGER CHANNEL'** label has changed to **'SIGNAL CHANNEL'**, and pressing this will revert to the previous screen of *para 4.5.3.1*. so this key toggles between the signal and trigger selection screens.

Pressing the **'EXIT'** key will revert back to the standard DC/Square screen of *para 4.5.2*.

Note that in the bottom right corner of the screen, the expected load selection label has disappeared, because as yet no trigger channel has been selected. The label will be reinstated if an active head is chosen to carry the trigger, but if a cable is used a trigger load of 50Ω will always be expected.

#### 4.5.3.3 Trigger Channel Selection

Any of the channels can be selected for trigger, so long as it is not already allocated as a signal channel. In the screen of *para 4.5.3.2*, the top central box shows Channel 1 as the signal channel, and unavailable for trigger. Attempting to use an occupied channel will result in a 'bleep' and an error message.

If it is necessary to use an occupied channel for triggers, its allocation as a signal channel must be de-selected. Similarly, a channel already occupied as a trigger channel cannot also be used as a signal channel. The first use to be allocated to a channel is dominant, and must be first de-selected to change its use.

Pressing an unoccupied channel key will highlight the key's label and change the legend in the top central box. For instance, pressing the **'TRIGGER CH 3'** key has the following effect:

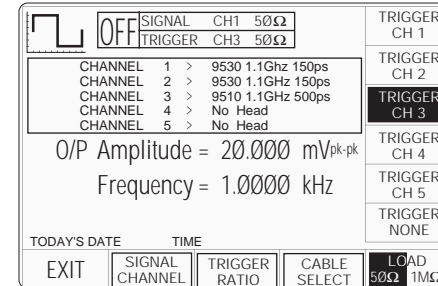

The expected load value can be changed from 50Ω to 1MΩ using the bottom left corner toggle key.

#### 4.5.3.4 Cable Selection

If it is intended to use a cable instead of a full head to convey the trigger, then a channel with no head fitted must be selected. In this case, for example, pressing the **'TRIGGER CH 5'** key has the following effect:

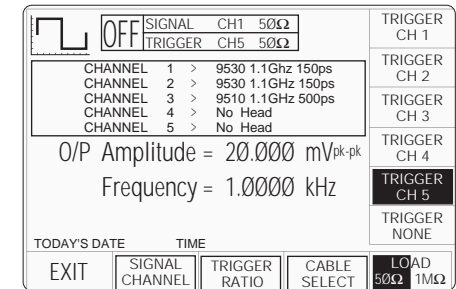

This channel must be allocated as a 'cable' channel; accessed by pressing the **'CABLE SELECT'** key. A new screen is presented:

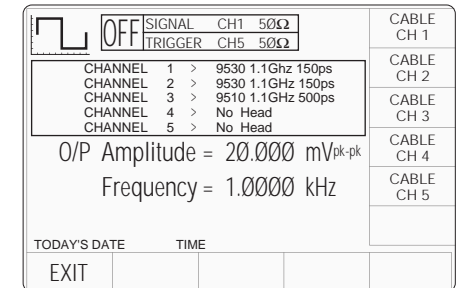

Pressing the **'CABLE CH 5'** key has the following effect:

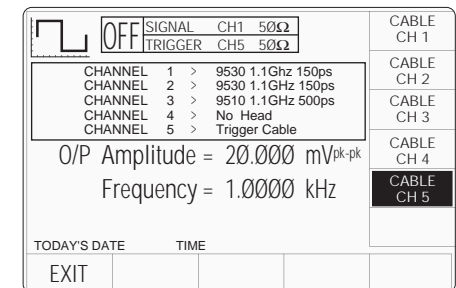

Having made the selection, pressing **'EXIT'** returns to the trigger selection screen:



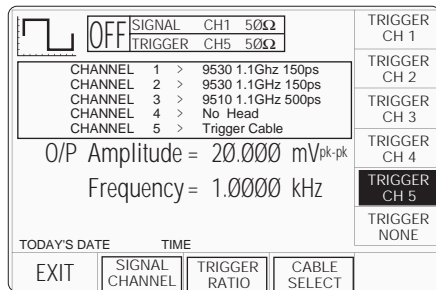

Note that the expected load key in the bottom right corner is now de-activated, and the trigger state legend in the top central box is fixed on 50Ω. A further selection is available, to choose the trigger ratio.

#### 4.5.3.5 Trigger Ratio

The 'Trigger Ratio' is the ratio of the trigger frequency to the that of the waveform itself. Three ratios are available: '+1', '+10' and '+100'. Pressing the 'TRIGGER RATIO' key presents the following screen:

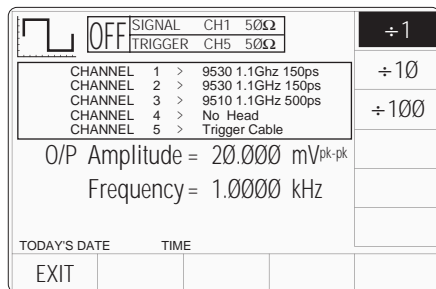

Pressing first the required ratio, then 'EXIT' returns to the trigger selection screen. On this screen, no indication of the trigger ratio is given.

**Note:** Beware that a low frequency subdivided in this way could lead to a very long delay before a trigger occurs.

#### 4.5.3.6 Retained Channel Memory

All selections made for Signal Channel, Trigger Channel, Cable Select and Trigger Ratio are retained in non-volatile memory within the 9500B. Changing modes and functions; and powering the instrument on and off will not alter these selections.

For this reason, there are no true defaults for these parameters, although on receipt from manufacture you should find the following selections are already made:

Signal Channel: 1  
 Trigger Channel: NONE  
 Cable Select: Not selected  
 Trigger Ratio: +1

#### 4.5.3.7 Choosing a Waveshape

All waveshapes in this function can be selected on a second menu screen. This is activated by pressing the 'WAVEFORM' screen key on the bottom row. The screen changes to show the available waveshapes:

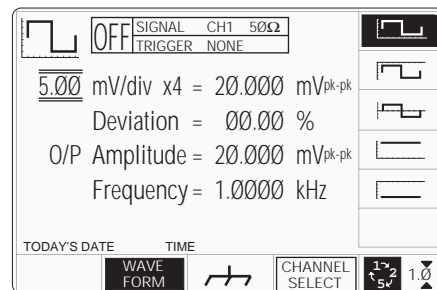

The WAVEFORM key label is highlighted to indicate that waveform selection is available, as is the presently-selected waveform icon.

Pressing one of the waveform keys (for example: the  key) to select a different waveform will return to the previous screen, with the icon of the selected waveform showing in the top left corner:

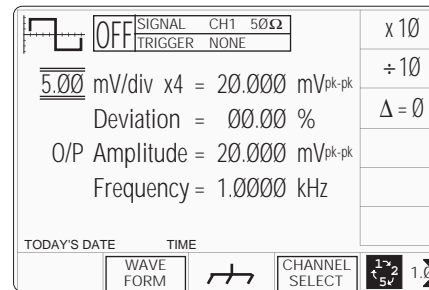

#### 4.5.3.8 DC Selection

Pressing one of the two DC keys, for example: the  (DC Negative) key, will return to the previous screen, with the DC Negative icon showing in the top left corner. The parameters listed on the screen will be changed to reflect DC instead of Square:

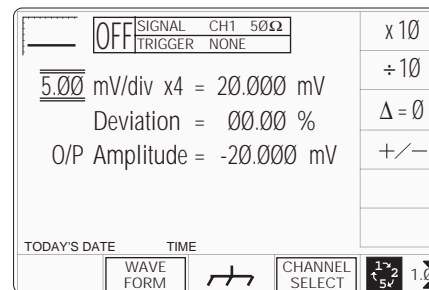

#### 4.5.3.9 DC/Square Selection Summary

'DC' and 'Square' can be regarded as a combined dual function, as each has a similar purpose, and switching between the two is accomplished by selection in a common 'Waveform' menu. The parametric differences are evident once the appropriate waveform soft key has been pressed.

Detailed operation follows below:

- paras 4.5.4 (DC/Square Operation)*
- paras 4.5.5/6 (Square Operation)*
- paras 4.5.7/8 (DC Operation).*





*Final Width = 215mm*

Final Width = 215mm

#### 4.5.4 DC/Square Operation

##### 4.5.4.1 Right Side Screen Keys — Digit Edit / Sequence Scroll

Keys operate on the value marked by the cursor. The key labels will change depending on the cursor position, as indicated.:



- i. Cursor on Units/div:**
  - X10 Multiplies the Units/div by ten.
  - +10 Divides the Units/div by ten.
  - $\Delta = \emptyset$  Toggles the Deviation value between the marked value and zero.
  - +/- Toggles the value between positive and negative (DC only).
- ii. Cursor on Multiplier:**
  - $\Delta = \emptyset$  Toggles the Deviation value between the marked value and zero.
  - +/- Toggles the value between positive and negative (DC only).
- iii. Cursor on Deviation:**
  - $\Delta = \emptyset$  Toggles the Deviation value between the marked value and zero.
  -   $\Delta\%$  Press to set Deviation value in absolute units.
  - $\Delta\%$   Press to set Deviation value in percent of set value.
- iv. Cursor on Frequency/Period:**
  - X10 Multiplies the marked value by ten.
  - +10 Divides the marked value by ten.
  - $\Delta = \emptyset$  Toggles the Deviation value between the marked value and zero.
  -   $\frac{1}{f}$  Press to change display from Frequency to Period (not DC).
  - $\frac{1}{f}$   Press to change display from Period to Frequency (not DC).

##### 4.5.4.2 Right Side Screen Keys — Numeric Entry

Right side screen keys operate on the value in the edit box, and acting in place of the  $\downarrow$  key, exit from Numeric Entry back to Digit Edit/Sequence Scroll; then set the value as evaluated in the box:

- Cursor on Deviation:**
  - % Evaluates the number in the box in **Deviation Percentage**.
  - V Evaluates the number in the box in **Volts**.
  - mV Evaluates the number in the box in **Millivolts**.
  - $\mu$ V Evaluates the number in the box in **Microvolts**.

##### 4.5.4.3 Bottom Screen Keys — Digit Edit, Sequence Scroll and Numeric Entry

- WAVE FORM Provides a second menu screen for selection between three Square waveshapes or  $\pm$ DC. (*paras 4.5.3.7-9*).
-  With output on, the output to the UUT is grounded, for any waveform or DC selection.
- CHANNEL SELECT Permits the screen signal setup to be routed to any of the five heads, allowing selection of trigger channel, trigger ratio and cable channel (*paras 4.5.3*).
-  1.2 Press to select Direct Mode (*paras 4.4.3/4*).
-  1.2 1.0 Press to select Scope Mode (setting the step sequence to '1, 2, 5' or '1, 2, 2.5, 4, 5' as chosen using the Preferences key) (*paras 4.4.1/2*).

#### 4.5.5 Square Operation

##### 4.5.5.1 Value Editing

###### Amplitude

At maximum and minimum output voltages, the screen settings of the contributors' values (units/division, scaling multiplier and deviation) are limited by the output voltage itself. For example:

Contributor	$\Omega_{LOAD} = 1M\Omega$		$\Omega_{LOAD} = 50\Omega$	
	Minimum	Maximum	Minimum	Maximum
Output Voltage Limit	35.52 $\mu$ V p-p	222.4V p-p	35.52 $\mu$ V p-p	5.56V p-p
Units/Division	10 $\mu$ V/div	50V/div	10 $\mu$ V/div	2V/div
Scaling Multiplier	1	10	1	10
Deviation	-11.20%	+11.20%	-11.20%	+11.20%

Provided they do not exceed the output voltage limits shown, the contributors have the following adjustments (Scope mode):

- Units/Division in Volts/division (adjustable sequence: 1-2-5 or 1-2-2.5-4-5; default 5mV).
- Scaling Multiplier (adjustable through integers 1 to 10; default 4).
- Percentage Deviation (a maximum range of  $\pm 11.20\%$  about the value of (a)  $\times$  (b), at a resolution of four significant digits, with two decimal places; default zero). Digit Edit or Numeric Entry can be used.
- Output Voltage (adjustable only by manipulation of (a), (b) and (c); default 20.000mV).

#### 4.5.5.2 Output Voltage Editing

The editing processes follow the same general rules as for editing voltages described in *paras 4.4*.

#### Tab $\rightarrow$ Key and Cursors (Scope Mode)

Repeatedly pressing this key moves the cursor from the default units/division to the Multiplier, then to the Deviation and back to the units/division. The type of cursor at each position indicates the type of adjustment possible.

#### Units/Division (Scope Mode)

The type of cursor (barred) used for the units/division signifies that the value can be adjusted only as a step-sequence value using the  $\uparrow$  and  $\downarrow$  keys. The  $\leftarrow$  and  $\rightarrow$  keys are inactive.

From the default '5mV/div', the value can be raised using the  $\uparrow$  key by increments through 10mV/div, 20mV/div, 50mV/div and so on up to 50V/div, providing that the other contributors will not take the output voltage value above 5.56V p-p (50 $\Omega$  load) or 222.40V p-p (1M $\Omega$  load). Similarly, the  $\downarrow$  key will reduce the Units/Division down to 10 $\mu$ V/div, unless the output voltage would fall below 35.52 $\mu$ V p-p (both 50 $\Omega$  and 1M $\Omega$  loads).

#### Multiplier (Scope Mode)

Again the  $\leftarrow$  and  $\rightarrow$  keys are inactive.

From the default 'x 4', the value can be changed using the  $\uparrow$  and  $\downarrow$  keys, by single integer increments to values between 1 and 10, providing that the other contributors do not take the output voltage value out of its limits. The product of the units/division and multiplier are shown on the right side of the '=' sign.

#### Deviation (Scope and Direct Mode)

The triangular type of cursor indicates that all the cursor keys can be used.

From the default 00.00%, the deviation percentage can be changed to any value within its resolution between -11.20% and +11.20%, providing that the other contributors do not take the output voltage value out of its limits. The result of combining the units/division, multiplier and deviation are shown as the value of 'O/P Volts p-p'.

#### Output Voltage (Scope and Direct Mode)

The O/P Amplitude is only adjustable by means of its contributors.

From the default 20.000mV p-p, the output voltage can be changed to any value within its resolution between 35.52 $\mu$ V p-p (both 50 $\Omega$  and 1M $\Omega$  loads) and 5.56V p-p (50 $\Omega$  load) or 222.40V p-p (1M $\Omega$  load).

#### Frequency (Scope and Direct Mode)

From the default 1kHz, the output frequency can be changed to any value within its resolution between 10Hz and 100kHz.

#### 4.5.5.3 Low Voltage (LV) and High Voltage (HV) States

In the interests of safety, to avoid electric shock, the 9500B incorporates a high-voltage interlock system for DC/Square and High Edge functions. The interlock threshold voltage can be chosen by the user between 10V and 110V, otherwise a default threshold value of 100V is set. The active threshold value is stored in non-volatile memory.

Any voltage below the threshold can be output without hindrance, but voltages on or above the threshold cannot be output without deliberate action being taken to enter the high voltage (HV) state. Once entered, a continuous audible signal acts as a reminder that HV state is active.

The system exits from HV state when the output voltage is brought down below HV state's lower limit. This is always 10% less than the active threshold value, allowing some adjustment of output without the irritation of having to change states.

Each threshold value is related to the output value set on the screen, including Deviation. The default state boundaries are shown in *Fig. 4.5.1*. The values given in the figure translate to DC volts in DCV function, and pk-pk volts in Square and High Edge functions.

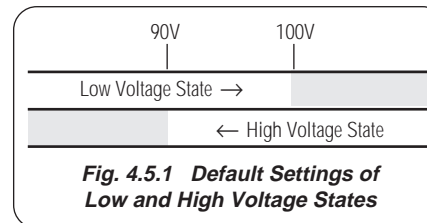

*Final Width = 215mm*

*continued overleaf →*

Final Width = 215mm

#### 4.5.5 Square Operation (Contd.)

##### 4.5.5.3 Low Voltage (LV) and High Voltage (HV) States (Contd.)

###### Increasing Output Voltage into High Voltage State

When increasing output value using any method; if the new value will be at or greater than the upper threshold and OUTPUT is OFF, HV state will be activated but no effect will be observed. If OUTPUT is ON, it will remain ON at its latest value. The operator will be prompted, by audible warning, and error message: 'Confirm with ON', that HV State is required. This is done by pressing the OUTPUT ON key again; then, after a short delay, the output voltage will be raised to the new voltage in HV state.

While OUTPUT is ON in HV state, a distinctive, pulsing tone is emitted. Once in HV state, OUTPUT can be turned ON and OFF with no need to confirm.

###### Decreasing Output Voltage out of High Voltage State

When decreasing output value using any method; if the new value will be less than the lower limit of HV State, then the LV state will be activated. No warning will be given, except that the pulsing tone will cease. This rule applies whether OUTPUT is OFF or ON.

###### Applicability to Square Function

In Square Function, the output voltage can only rise above the minimum threshold setting of 10V, when the expected load setting is 1M $\Omega$ . High Voltage State cannot be entered when the expected load setting is 50 $\Omega$ .

#### 4.5.6 Using the 9500B Square Function to Calibrate the Amplitude Response of a UUT Oscilloscope

##### 4.5.6.1 Introduction

Two types of procedures for amplitude calibration are given:

- Using the 9500B as a fixed source, where the oscilloscope can be adjusted;
- Using the 9500B as an adjustable source, reading oscilloscope deviations via the 9500B screen.

##### 4.5.6.2 Interconnections

- Use the appropriate active head to connect from the required 9500B channel output to the input of the UUT Signal Channel to be calibrated.
- If a trigger is required, use an active head (or trigger cable) to connect from the required 9500B channel output to the input of the UUT Trigger for the Channel to be calibrated.

##### 4.5.6.3 UUT Scope — Amplitude Calibration using the 9500B as a Fixed Source

The following procedure assumes that the 9500B instrument is in Manual Mode. It is also assumed that the user will be familiar with the methods of editing screen values. In the case of difficulty, re-read the *paragraphs earlier in this Section 4*.

###### 9500B and UUT Oscilloscope Setup

###### 1. Preparation

Ensure that both instruments are powered ON and warmed up.

###### 2. UUT 'Scope

Select the required function for amplitude calibration.

###### 3. 9500B

Ensure that the 9500B is in Square Function with Output OFF. If in any other function, press the  soft key at the top right of the screen.

##### Sequence of Operations

Refer to the table or list of UUT Oscilloscope amplitude calibration points in the *UUT Oscilloscope Manufacturer's Calibration Guide*.

Follow the sequence of calibration stages as directed by the guide, and carry out the following operations (1) to (6) at each stage.

###### 1. 9500B

Use the front panel controls to set the 9500B Output to the required square wave p-p voltage, polarity, frequency and load impedance for the UUT 'Scope amplitude cal point:

###### 2. UUT 'Scope

- Select the correct channel for the cal point.
- Select the correct range for the cal point.

###### 3. 9500B Set Output ON.

###### 4. UUT 'Scope

- Adjust the sweep speed and trigger level for a stable display.
- Observe and note the amplitude response.

###### 5. Calibration

- If a calibration adjustment is provided, adjust the UUT's response to be appropriate to the settings on the 9500B screen, as detailed in the *UUT Oscilloscope Manufacturer's Calibration Guide*.
- If no adjustment is provided on the UUT 'Scope, record its response at the calibration point as detailed in the *UUT Oscilloscope Manufacturer's Calibration Guide*.

###### 6. 9500B Set Output OFF.

---

#### 4.5.6.4 UUT Oscilloscope — Amplitude Calibration using the 9500B as an Adjustable Source

The following procedure assumes that the 9500B instrument is in Manual Mode. It is also assumed that the user will be familiar with the methods of editing screen values. In the case of difficulty, re-read the *paragraphs earlier in this Section 4*.

##### 9500B and UUT Oscilloscope Setup

###### 1. Preparation

Ensure that both instruments are powered ON and warmed up.

###### 2. UUT 'Scope

Select the required function for amplitude calibration.

###### 3. 9500B

Ensure that the 9500B is in Square Function with Output OFF. If in any other function, press the  soft key at the top right of the screen.

##### Sequence of Operations

Refer to the table or list of UUT Oscilloscope amplitude calibration points in the *UUT Oscilloscope Manufacturer's Calibration Guide*.

Follow the sequence of calibration stages as directed by the guide, and carry out the following operations (1) to (6) at each stage.

###### 1. 9500B

Use the front panel controls to set the 9500B Output to the required square wave p-p voltage, polarity, frequency and load impedance for the UUT 'Scope amplitude cal point:

###### 2. UUT 'Scope

- a. Select the correct channel for the cal point.
- b. Select the correct range for the cal point.

###### 3. 9500B Set Output ON.

###### 4. UUT 'Scope

- a. Adjust the sweep speed and trigger level for a stable display.
- b. Observe and note the amplitude response.

###### 5. Calibration

- a. Use the 9500B Deviation control to slew the 9500B Output voltage until the UUT's response is appropriate to the 9500B settings, as detailed in the *UUT Oscilloscope Manufacturer's Calibration Guide*.

- b. Record the 9500B screen output voltage as detailed in the *UUT Oscilloscope Manufacturer's Calibration Guide*.

###### 6. 9500B Set Output OFF.

*Final Width = 215mm*

## 4.5.7 DC Operation

### 4.5.7.1 Polarity

#### Waveform Selection Screen

From the power-on default, pressing the **WAVEFORM** screen key transfers to the waveform menu screen:

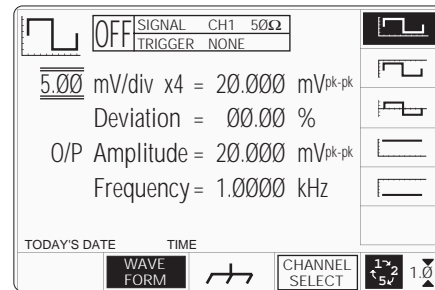

Both polarities of DC Voltage output are listed merely as different waveforms. As an example, pressing the  key from the setup shown above will present the DC function screen, showing negative values selected (of course, the frequency parameter has disappeared from the screen):

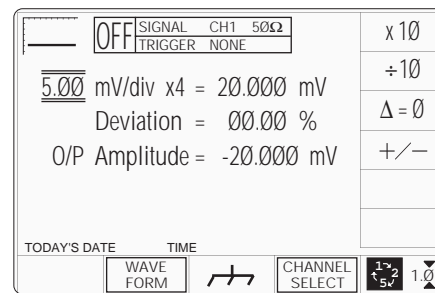

Once into DC function, it is not necessary to change the waveform to change polarity. Pressing the **+/-** screen key toggles between positive and negative DC Voltage. The polarity selection is shown by the function icon in the top left corner, confirmed by the **+** or **-** sign on the O/P Amplitude value.

### 4.5.7.2 Value Editing

#### Amplitude

At maximum and minimum output voltages, the screen settings of the contributors' values (units/division, scaling multiplier and deviation) are limited by the output voltage itself. For example:

Contributor	$\Omega_{LOAD} = 1M\Omega$		$\Omega_{LOAD} = 50\Omega$	
	Minimum	Maximum	Minimum	Maximum
Output Voltage Limit	$\pm 888.00\mu VDC$	$\pm 222.4V$ p-p	$\pm 888.00\mu VDC$	$\pm 5.56V$
Units/Division	0.20mV/div	50V/div	0.20mV/div	2V/div
Scaling Multiplier	1	10	1	10
Deviation	-11.20%	+11.20%	-11.20%	+11.20%

Provided they do not exceed the output voltage limits shown, the contributors have the following adjustments (Scope mode):

- Units/Division in Volts/division (adjustable sequence: 1-2-5 or 1-2-2.5-4-5; default 5mV).
- Scaling Multiplier (adjustable through integers 1 to 10; default 4).
- Percentage Deviation (a maximum range of  $\pm 11.20\%$  about the value of (a) x (b), at a resolution of four significant digits, with two decimal places; default zero). Digit or Numeric Entry can be used.
- Output Voltage (adjustable in Digit Edit/Sequence Scroll only, by manipulation of (a), (b) and (c); default 20.000mV).

### 4.5.7.3 Output Voltage Editing

The editing processes follow the same rules as for editing square waves (refer to *para 4.5.5.2*). Obviously no frequency adjustment is present, and polarity is changed as described in *para*

### 4.5.7.4 Low Voltage (LV) and High Voltage (HV) States

Entering and leaving High Voltage state in DC Function is governed by the same rules as for Square function (refer to *para 4.5.5.3*). In this case the threshold-setting limits are  $\pm 10VDC$  and  $\pm 110VDC$ , not pk-pk.

### 4.5.7.5 Multi Channel DC Operation

The 9500B is capable of simultaneous DC Output from all channels that have a 9510, 9520, 9530 or 9560 Active Head fitted.

Primarily to accelerate the Calibration of voltage linearity under automated remote control, the feature is also available to manual operators via the 9500B front panel controls and display.

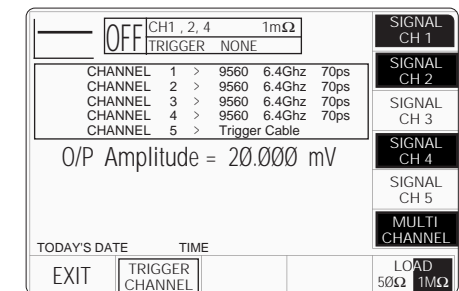

Final Width = 215mm

Whenever the DC waveform is selected within the DC/Square function an extra Soft Key is available in the CHANNEL SELECT sub menu.

Please note that Multi Channel DC Output may only be configured to drive a UUT input impedance of  $1M\Omega$

This key toggles Multi Channel capability ON and OFF. Whilst OFF, the operation of Channel Selection is unchanged and is as previously described. Refer *para 4.5.3.1.* Whilst ON (highlighted) each of the above Softkeys may be toggled ON or OFF, to select Output from any or all channels.

## 4.5.8 Using the 9500B DC Function to Calibrate the Amplitude Response of a UUT Oscilloscope

### 4.5.8.1 Introduction

Two types of procedures for amplitude calibration are given:

- a. Using the 9500B as a fixed source, where the oscilloscope can be adjusted;
- b. Using the 9500B as an adjustable source, reading oscilloscope deviations via the 9500B screen.

### 4.5.8.2 Interconnections

- a. Use the appropriate active head to connect from the required 9500B channel output to the input of the UUT Signal Channel to be calibrated.
- b. If a trigger is required, use the appropriate active head (or trigger cable) to connect from the required 9500B channel output to the input of the UUT Trigger for the Channel to be calibrated.

### 4.5.8.3 UUT Scope: Amplitude Calibration using the 9500B as a Fixed Source of DC Voltage

The following procedure assumes that the 9500B instrument is in Manual Mode. It is also assumed that the user will be familiar with the methods of editing screen values. In the case of difficulty, re-read *earlier paragraphs*.

#### 9500B and UUT Oscilloscope Setup



##### 1. Preparation

Ensure that both instruments are powered ON and warmed up.

##### 2. UUT 'Scope

Select the required function for amplitude calibration.

##### 3. 9500B

Ensure that the 9500B is in DC Function with Output OFF. If in any other function, press the  soft key at the top right of the screen, then press the **WAVEFORM** screen key. Select  or  as required.

#### Sequence of Operations

Refer to the table or list of UUT Oscilloscope amplitude calibration points in the *UUT Oscilloscope Manufacturer's Calibration Guide*.

Follow the sequence of calibration stages as directed by the guide, and carry out the following operations (1) to (8) at each stage.

*Final Width = 215mm*

*continued overleaf →*

Final Width = 215mm

#### 4.5.8 Using the 9500B DC Function to Calibrate the Amplitude Response of a UUT Oscilloscope (Contd.)

##### 1. 9500B

Use the front panel controls to set the 9500B Output to the required DC voltage, polarity and load impedance for the UUT 'Scope amplitude cal point:

2. **UUT 'Scope**
  - a. Select the correct channel for the cal point.
  - b. Select 'DC-Coupled', if required.
  - c. Select the correct range for the cal point.

##### 3. 9500B

- a. Press the  $\swarrow$  screen key on the bottom row to provide a zero reference.
- b. Set Output **ON**.

##### 4. UUT 'Scope

- a. Set the Y controls to place the trace on graticule zero.

##### 5. 9500B

Repress the  $\swarrow$  screen key on the bottom row to remove a zero reference.

##### 6. UUT 'Scope

- a. Auto-trigger the oscilloscope or use the 100Hz Trigger from the 9500B. Adjust the UUT for a stable display.
- b. Observe and note the DC level change from graticule zero.

##### 7. Calibration

- a. If a calibration adjustment is provided, adjust the UUT's response to be appropriate to the settings on the 9500B screen, as detailed in the *UUT Oscilloscope Manufacturer's Calibration Guide*.
- b. If no adjustment is provided on the UUT 'Scope, record its response at the calibration point as detailed in the *UUT Oscilloscope Manufacturer's Calibration Guide*.

8. **9500B** Set Output **OFF**.

##### 4.5.8.4 UUT Scope — Amplitude Calibration using the 9500B as an Adjustable Source of DC Voltage

The following procedure assumes that the 9500B instrument is in Manual Mode. It is also assumed that the user will be familiar with the methods of editing screen values. In the case of difficulty, re-read the *paragraphs earlier in this Section 4*.

##### 9500B and UUT Oscilloscope Setup



###### 1. Preparation

Ensure that both instruments are powered ON and warmed up.

###### 2. UUT 'Scope

Select the required function for amplitude calibration.

###### 3. 9500B

Ensure that the 9500B is in DC Function with Output OFF. If in any other function, press the  soft key at the top right of the screen, then press the **WAVEFORM** screen key. Select  or  as required.

###### Sequence of Operations

Refer to the table or list of UUT Oscilloscope amplitude calibration points in the *UUT Oscilloscope Manufacturer's Calibration Guide*.

Follow the sequence of calibration stages as directed by the guide, and carry out the following operations (1) to (8) at each stage.

##### 1. 9500B

Use the front panel controls to set the 9500B Output to the required DC voltage, polarity and load impedance for the UUT 'Scope amplitude cal point:

##### 2. UUT 'Scope

- a. Select the correct channel for the cal point.
- b. Select 'DC-Coupled', if required.
- c. Select the correct range for the cal point.

##### 3. 9500B

- a. Press the  $\swarrow$  screen key on the bottom row to provide a zero reference.
- b. Set Output **ON**.

##### 4. UUT 'Scope

- a. Set the Y controls to place the trace on graticule zero.

##### 5. 9500B

Repress the  $\swarrow$  screen key on the bottom row to remove a zero reference.

##### 6. UUT 'Scope

- a. Auto-trigger the oscilloscope or use the 100Hz Trigger from the 9500B. Adjust the UUT for a stable display.
- b. Observe and note the DC level change from graticule zero.

##### 7. Calibration

- a. Use the 9500B Deviation control to slew the 9500B Output voltage until the UUT's response is appropriate to the 9500B settings, as detailed in the *UUT Oscilloscope Manufacturer's Calibration Guide*.
- b. Record the 9500B screen output voltage as detailed in the *UUT Oscilloscope Manufacturer's Calibration Guide*.

8. **9500B** Set Output **OFF**.



## 4.6 Sine Function

### 4.6.1 Introduction

This sub-section is a guide to the use of the 9500B to generate sine waves for flatness and bandwidth calibration of oscilloscopes.

For those users who require more detailed instructions for interconnections, and manipulating the front panel controls, refer to *sub-sections 4.2, 4.3 and 4.4*. Section 4.6 is divided into the following sub-sections:

4.6.1	Introduction .....	4.6-1
4.6.2	Default Settings .....	4.6-1
4.6.3	Menu Selections .....	4.6-1
4.6.3.1	Retained Channel Memory .....	4.6-1
4.6.3.2	Right Side Screen Keys - Digit Edit/ Sequence Scroll .....	4.6-1
4.6.3.3	Right Side Screen Keys - Numeric Entry .....	4.6-2
4.6.3.4	Bottom Screen Keys - Digit Edit/Sequence Scroll and Numeric Entry .....	4.6-2
4.6.4	Sinewave Operation .....	4.6-2
4.6.4.1	Value Editing .....	4.6-2
4.6.4.2	Output Voltage Editing .....	4.6-2
4.6.5	Dual Channel Operation .....	4.6-3
4.6.5.1	Dual Channel Selection .....	4.6-3
4.6.6	Using the 9500B Levelled Sine Function to Calibrate the Flatness/Bandwidth Response of a UUT Oscilloscope .....	4.6-4
4.6.6.1	Introduction .....	4.6-4
4.6.6.2	Interconnections .....	4.6-4
4.6.6.3	Common Setup .....	4.6-4
4.6.6.4	UUT Scope - Flatness Calibration using the 9500B as a Fixed Source .....	4.6-4
4.6.6.5	UUT Scope - Flatness Calibration using the 9500B as an Adjustable Source .....	4.6-4

### 4.6.2 Default Settings

When Manual mode is selected the system defaults into DC/Square function and shows the DC/Square function initial menu screen. Sine function can be accessed by pressing the  function key on the right of the 'OSCILLOSCOPE CALIBRATOR' panel.

Whenever the  menu screen is opened, except on recovery from a standby period, it will appear with the following default settings:

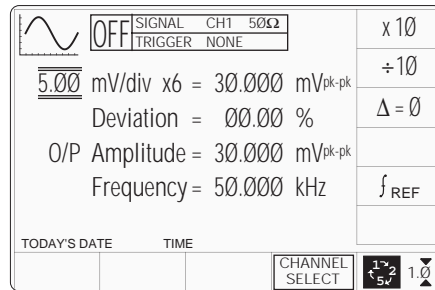

The above default screen has auto-selected the frequency of 50kHz. Deviation has defaulted to zero, and output voltage to 30.000mVp-p. Frequency is variable between 0.1Hz and 1.1GHz (variant 9500B/1100 — for other variants refer to specifications in *Section 7*).

### 4.6.3 Menu Selections





Except for Dual Channel operation (*paras 4.6.5*), all Signal Channel selection, Trigger Channel selection, Cable selection and Trigger Ratio operate in the same way as in DC/Square function. Refer to *paras 4.5.3*.

#### 4.6.3.1 Retained Channel Memory

Refer to *para 4.5.3.6*.

#### 4.6.3.2 Right Side Screen Keys — Digit Edit/Sequence Scroll

Keys operate on the value marked by the cursor. The key labels will change depending on the cursor position, as indicated in the next column:

- |   |   |  |
|---|---|--|
| <b>i.</b>   | <b>Cursor on Units/div:</b>                                       |  |
| X10   | Multiplies the Units/div by ten.                                  |  |
| ÷10   | Divides the Units/div by ten.                                     |  |
| Δ = 0   | Toggles the Deviation value between the marked value and zero.    |  |
| f REF   | Toggles between the marked frequency and the reference frequency. |  |
| <b>ii.</b>  | <b>Cursor on Multiplier:</b>                                      |  |
| Δ = 0   | Toggles the Deviation value between the marked value and zero.    |  |
| f REF   | Toggles between the marked frequency and the reference frequency. |  |
| <b>iii.</b>   | <b>Cursor on Deviation:</b>                                       |  |
| Δ = 0   | Toggles the Deviation value between the marked value and zero.    |  |
|    | Press to set Deviation value in absolute units.                   |  |
|    | Press to set Deviation value in percent of set value.             |  |
| f REF   | Toggles between the marked frequency and the reference frequency. |  |
| <b>iv.</b>  | <b>Cursor on Frequency/Period:</b>                                |  |
| X10   | Multiplies the marked value by ten.                               |  |
| ÷10   | Divides the marked value by ten.                                  |  |
| Δ = 0   | Toggles the Deviation value between the marked value and zero.    |  |
| f REF   | Toggles between the marked frequency and the reference frequency. |  |
|  | Press to change display from Frequency to Period.                 |  |
|  | Press to change display from Period to Frequency.                 |  |

*Final Width = 215mm*

Final Width = 215mm

### 4.6.3 Menu Selections (Contd.)

#### 4.6.3.3 Right Side Screen Keys — Numeric Entry

Right side screen keys operate on the value in the edit box, and acting in place of the ↵ key, exit from Numeric Entry back to Digit Edit/Sequence Scroll; then set the value as evaluated in the box:

##### Cursor on Deviation:

- % Evaluates the number in the box in **Deviation Percentage.**
- V Evaluates the number in the box in **Volts.**
- mV Evaluates the number in the box in **Millivolts.**

##### Cursor on Frequency:

- Hz Evaluates the number in the box in **Hertz.**
- KHz Evaluates the number in the box in **Kilohertz.**
- MHz Evaluates the number in the box in **Megahertz.**
- GHz Evaluates the number in the box in **Gigahertz.**

#### 4.6.3.4 Bottom Screen Keys — Digit Edit/Sequence Scroll and Numeric Entry

CHANNEL SELECT Permits the screen signal setup to be routed to any of the five heads, allowing selection of trigger channel, trigger ratio and cable channel (*paras 4.5.3*).

 Currently in Scope mode. Press to select Direct Mode (*paras 4.4.3/4*).

 Currently in Direct mode. Press to select Scope Mode (setting the step sequence to '1, 2, 5' or '1, 2, 2.5, 4, 5' as chosen using the Preferences key) (*paras 4.4.1/2*).

### 4.6.4 Sine Function Operation

#### 4.6.4.1 Value Editing

##### Amplitude

At maximum and minimum output voltages, the screen settings of the contributors' values (units/division, scaling multiplier and deviation) are limited by the output voltage itself (*refer to Table 4.6.4.1*).

	Frequency: 100mHz - 550.00MHz		Frequency: 550.01MHz - 1.1GHz	
	Minimum	Maximum	Minimum	Maximum
Output Voltage Limit	4.44mV p-p	5.56V p-p	4.44mV p-p	3.336V p-p
Units/Division	1mV/div	2V/div	1mV/div	2V/div
Scaling Multiplier	1	10	1	10
Deviation	-11.20%	+11.20%	-11.20%	+11.20%

**Table 4.6.4.1 Sine Function — Output Voltage Limits and Contributors Limits**

Provided they do not exceed the output voltage limits shown, the contributors have the following adjustments (Scope mode):

- a. Units/Division in Volts/division in the adjustable sequence: 1 - 2 - 5 or (using 'Pref') 1 - 2 - 2.5 - 4 - 5; default 5mV/div.
- b. Scaling Multiplier (adjustable through integers 1 to 10; default 6).
- c. Percentage Deviation (a maximum range of  $\pm 11.20\%$  about the value of (a)  $\times$  (b), at a resolution of four significant digits, with two decimal places; default zero). Digit Edit, Sequence Scroll or Numeric Entry can be used.
- d. Output Voltage (adjustable in Digit Edit/Sequence Scroll only, by manipulation of (a), (b) and (c); default 30.000mV).





#### 4.6.4.2 Output Voltage Editing



Editing follows the same general rules as for editing voltages described in *paras 4.4*.

##### Tab Key and Cursors (Scope Mode)





Repeatedly pressing this key moves the cursor from the default Units/Division to the Multiplier, then Deviation, finally to the Frequency and back to the Units/Division. The type of cursor at each position indicates the type of adjustment possible to that value.

##### Units/Division (Scope Mode)

The type of cursor (barred) used for the units/division signifies that the value can be adjusted only as a step-sequence value using the  and  keys. The  and  keys are inactive.

From the default '5mV/div', the value can be raised using the  key by increments through 10mV/div, 20mV/div, 50mV/div and so on up to 2V/div, providing that the other contributors will not take the output voltage value above 5.56Vp-p ( $\leq 550\text{MHz}$ ) or 3.336Vp-p ( $> 550\text{MHz}$ ). Similarly, the  key will reduce the Units/Division down to 1mV/div, unless the output voltage would fall below 4.44mVp-p (all frequencies).

##### Multiplier (Scope Mode)

Again the  and  keys are inactive. From the default 'x 6', the value can be changed using the  and  keys, by single integer increments to values between 1 and 10, providing that the other contributors do not take the output voltage value out of its limits. The product of the units/division and multiplier are shown on the right side of the '=' sign.

---

**Deviation (Scope and Direct Mode)**

The triangular type of cursor indicates that all the cursor keys can be used as in other functions. From the default 00.00%, the deviation percentage can be changed to any value within its resolution between -11.20% and +11.20%. The result of combining the units/division, multiplier and deviation are shown as the p-p value of 'O/P Amplitude'.

**Output Voltage (Scope and Direct Mode)**

The O/P Amplitude is only adjustable by means of its contributors.

**Frequency (Scope and Direct Mode)**

The triangular type of cursor indicates that all the cursor keys can be used.

From the default 50kHz, the output frequency can be changed to any value within its resolution between 100mHz and 1.1GHz (O/P Amplitude  $\leq 3.336\text{Vp-p}$ ) or between 100mHz and 550MHz (any valid O/P Amplitude).

**4.6.4.3 Limitations for UUT Scope input impedance of  $1\text{M}\Omega$** 

The selection of UUT Oscilloscope input impedance of  $50\Omega$  is strongly recommended when using the Sine Function at high frequency (e.g.  $>100\text{MHz}$ ). This ensures that the 9500B output signal is correctly terminated within the UUT.

There are however many Oscilloscopes that do not feature an input  $50\Omega$  terminator. To address these instruments the 9500B, when configured to drive 1MW, applies its own  $50\Omega$  terminator within the Active Head (9510, 9520, 9530 only). However the effectiveness of this approach is limited by short but finite signal path length to the UUT input amplifiers and their input capacitance. Substantial Sine amplitude errors may result from this unterminated transmission line.

Error magnitude and the frequency at which it becomes significant may vary as UUT input attenuators are selected (V/div adjustment) and are highly dependent upon UUT design and construction.

Errors due to signal path length may be reduced slightly by using a BNC 50W thru termination between the 9500 output and the UUT input. Again effectiveness will be limited by remaining path length and capacitance within the UUT.

In all cases frequencies above 500MHz are not recommended for use into UUT input

*Final Width = 215mm*

## 4.6.5 Dual Channel Operation

### 4.6.5.1 Dual Channel Selection (Two channels/heads activated)

For certain oscilloscope test and calibration procedures, such as 'channel trigger sensitivity' and 'X/Y test', it is necessary to provide the oscilloscope with two identical sinewave signals. Dual Channel Sine function allows the 9500B and UUT oscilloscope to remain connected, without the need to insert physical cable couplers. This is particularly useful during automated calibration and test.

**N.B.** For this function two heads must be connected and activated.

When two channels are used, it is necessary to choose one of the channels as 'Master', and one as 'Slave'. The Master channel controls the feedback, whereas the Slave repeats the signal. To select two channels, press the CHANNEL SELECT soft key to select the Master channel, in this case Signal Channel 3:

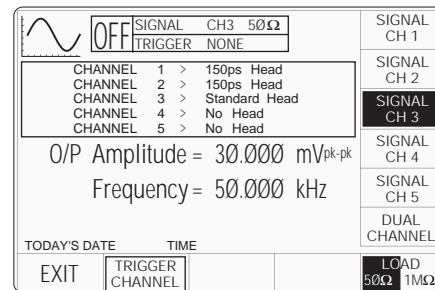

Now press the DUAL CHANNEL soft key, and the Dual Channel screen icon will appear.

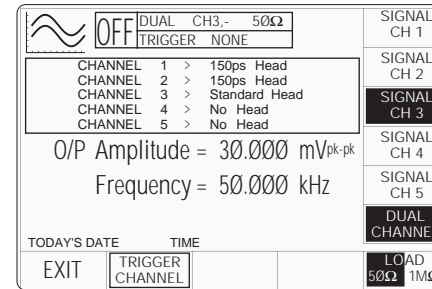

Next select the Slave channel, in this case Signal Channel 2:

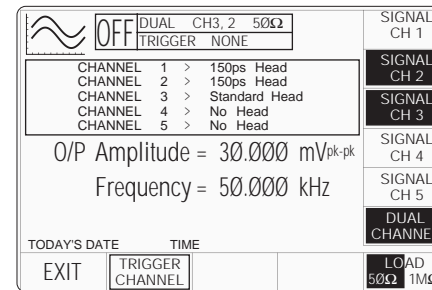

Both channel key labels and the Dual channel label are highlighted, and the legend in the box at the top of the screen shows the two channels selected, the Master written first.

Pressing EXIT will return to the main Dual Channel Sine screen, so that other parameters can be set:

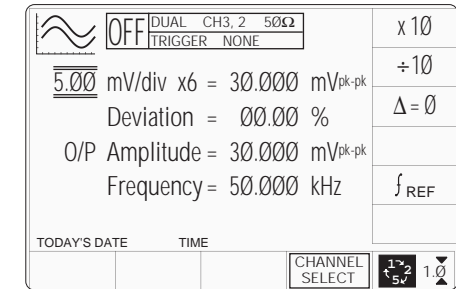

Note that the upper sinewave amplitude range limits are halved by invoking Dual Channel Sine function.

*Final Width = 215mm*

## 4.6.6 Using the 9500B Levelled Sine Function to Calibrate the Flatness/Bandwidth Response of a UUT Oscilloscope

### 4.6.6.1 Introduction

Two types of procedures for flatness and bandwidth calibration are given:

- a. Using the 9500B as a fixed source, where the oscilloscope can be adjusted;
- b. Using the 9500B as an adjustable source, reading oscilloscope deviations via the 9500B screen.

### 4.6.6.2 Interconnections

- a. Use an active head to connect from the required 9500B channel output to the input of the UUT Signal Channel to be calibrated.
- b. If a trigger is required, use an active head (or trigger cable) to connect from the required 9500B channel output to the input of the UUT Trigger.

### 4.6.6.3 Common Setup

The following procedures assume that the 9500B instrument is in Manual Mode. It is also assumed that the user will be familiar with the methods of editing screen values. In the case of difficulty, re-read the *paragraphs earlier in this Section 4*.

#### 9500B and UUT Oscilloscope Setup

##### 1. Preparation

Ensure that both instruments are powered ON and warmed up.

##### 2. UUT 'Scope

Select the required function for flatness calibration.

##### 3. 9500B

Ensure that the 9500B is in Sine Function with Output OFF. If in any other function, press the  key at the right of the front panel.

### 4.6.6.4

#### UUT Scope — Flatness Calibration using the 9500B as a Fixed Source

##### Sequence of Operations

Refer to the table or list of UUT Oscilloscope flatness calibration points in the *UUT Oscilloscope Manufacturer's Calibration Guide*.

Follow the sequence of calibration stages as directed by the guide, and carry out the following operations (1) to (6) at each stage.

##### 1. 9500B

Use the front panel controls to set the 9500B Output to the required sine wave p-p voltage, frequency and load impedance for the UUT 'Scope flatness cal point:

##### 2. UUT 'Scope

- a. Select the correct channel for the cal point.
- b. Select the correct range for the cal point.

##### 3. 9500B Set Output ON.

##### 4. UUT 'Scope

- a. Adjust the sweep speed and trigger level for a stable display.
- b. Observe and note the amplitude response.

##### 5. Calibration

- a. If a calibration adjustment is provided, adjust the UUT's response to be appropriate to the settings on the 9500B screen, as detailed in the *UUT Oscilloscope Manufacturer's Calibration Guide*.
- b. If no adjustment is provided on the UUT 'Scope, record its response at the calibration point as detailed in the *UUT Oscilloscope Manufacturer's Calibration Guide*.

##### 6. 9500B Set Output OFF.

### 4.6.6.5

#### UUT Oscilloscope — Flatness Calibration using the 9500B as an Adjustable Source

##### Sequence of Operations

Refer to the table or list of UUT Oscilloscope amplitude calibration points in the *UUT Oscilloscope Manufacturer's Calibration Guide*.

Follow the sequence of calibration stages as directed by the guide, and carry out the following operations (1) to (6) at each stage.

##### 1. 9500B

Use the front panel controls to set the 9500B Output to the required sine wave p-p voltage, frequency and load impedance for the UUT 'Scope flatness cal point:

##### 2. UUT 'Scope

- a. Select the correct channel for the cal point.
- b. Select the correct range for the cal point.

##### 3. 9500B Set Output ON.

##### 4. UUT 'Scope

- a. Adjust the sweep speed and trigger level for a stable display.
- b. Observe and note the amplitude response.

##### 5. Calibration

- a. Use the 9500B Deviation control to slew the 9500B Output voltage until the UUT's response is appropriate to the 9500B settings, as detailed in the *UUT Oscilloscope Manufacturer's Calibration Guide*.
- b. Record the 9500B screen output voltage as detailed in the *UUT Oscilloscope Manufacturer's Calibration Guide*.

##### 6. 9500B Set Output OFF.

*Final Width = 215mm*

---

*Final Width = 215mm*

## 4.7 Edge Function

### 4.7.1 Introduction

This sub-section is a guide to the use of the 9500B for generating defined pulse edges to examine oscilloscope pulse response.

For those users who require more detailed instructions for interconnections, and manipulating the front panel controls, refer to *sub-sections 4.2, 4.3 and 4.4.*

4.7.1	Introduction .....	4.7-1
4.7.2	Default Settings .....	4.7-1
4.7.3	Menu Selections .....	4.7-1
4.7.3.1	Retained Channel Memory .....	4.7-1
4.7.3.2	Right Side Screen Keys - Digit Edit .....	4.7-1
4.7.3.3	Right Side Screen Keys - Direct Edit .....	4.7-2
4.7.3.4	Bottom Screen Keys - Digit and Direct Edit .....	4.7-2
4.7.4	Edge Function Operation .....	4.7-2
4.7.4.1	Value Editing .....	4.7-2
4.7.4.2	Output Voltage Editing .....	4.7-2
4.7.4.3	Low Voltage (LV) and High Voltage (HV) States .....	4.7-3
4.7.5	Using Active Head Models 9510, 9520, 9530 .....	4.7-3
4.7.5.1	Introduction .....	4.7-3
4.7.6	Using the 9500B Edge Function to Calibrate the Pulse Response of a UUT Oscilloscope .....	4.7-4
4.7.6.1	Introduction .....	4.7-4
4.7.6.2	Interconnections .....	4.7-4
4.7.6.3	Common Setup .....	4.7-4
4.7.6.4	UUT Scope - Pulse Response Calibration using the 9500B as a Fixed Source .....	4.7-4

### 4.7.2 Default Settings

When Manual mode is selected the system defaults into DC/Square function and shows the DC/Square function initial menu screen. Edge function can be accessed by pressing the  function key on the right of the 'OSCILLOSCOPE CALIBRATOR' panel.

Whenever the Edge menu screen is opened, except on recovery from a standby period, it will appear with the following default settings:

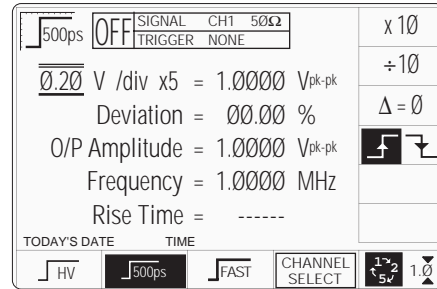

The above default screen has auto-selected a frequency of 1MHz, a rise time of 500ps, zero deviation and an output level of 1Vpk-pk.

### 4.7.3 Menu Selections



Signal Channel selection, Trigger Channel selection, Cable selection and Trigger Ratio all operate in the same way as in DC/Square function. Refer to *paras 4.5.3.*











#### 4.7.3.1 Retained Channel Memory

Refer to *para 4.5.3.6.*

#### 4.7.3.2 Right Side Screen Keys — Digit Edit

Keys operate on the value marked by the cursor. The key labels will change depending on the cursor position, as indicated.:

- i. **Cursor on Units/div:**
  - X10 Multiplies the Units/div by ten.
  - ÷10 Divides the Units/div by ten.
  - Δ = 0 Toggles the Deviation value between the marked value and zero.
  -  Press to select falling edge (Function icon follows).
  -  Press to select rising edge (Function icon follows).

- ii. **Cursor on Multiplier:**
  - Δ = 0 Toggles the Deviation value between the marked value and zero.
  -  Press to select falling edge (Function icon follows).
  -  Press to select rising edge (Function icon follows).
- iii. **Cursor on Deviation:**
  - Δ = 0 Toggles the Deviation value between the marked value and zero.
  -  Press to select falling edge (Function icon follows).
  -  Press to select rising edge (Function icon follows).
  - Δ% ΔV Press to set Deviation value in absolute units.
  - Δ% ΔV Press to set Deviation value in percent of set value.
- iv. **Cursor on Frequency/Period:**
  - X10 Multiplies the marked value by ten.
  - ÷10 Divides the marked value by ten.
  - Δ = 0 Toggles the Deviation value between the marked value and zero.
  -  Press to select falling edge (Function icon follows).
  -  Press to select rising edge (Function icon follows).
  -  Press to change display from Frequency to Period.
  -  Press to change display from Period to Frequency.
- v. **Cursor on Fast:**
  -  Press to select 150ps pulse function. (Function icon follows).
  -  Press to select 70ps pulse function. (Function icon follows).
  -  Press to select 25ps pulse function. (Function icon follows).

*Final Width = 215mm*

*continued overleaf →*

Final Width = 215mm

### 4.7.3 Menu Selections (Contd.)





#### 4.7.3.3 Right Side Screen Keys — Direct Edit

Right side screen keys operate on the value in the edit box, and acting in place of the ↵ key, exit from Direct Edit back to Digit Edit; then set the value as evaluated in the box:

##### Cursor on Deviation:

- % Evaluates the number in the box in **Deviation Percentage**.
- V Evaluates the number in the box in **Volts**.
- mV Evaluates the number in the box in **Millivolts**.

#### 4.7.3.4 Bottom Screen Keys — Digit and Direct Edit

-  HV Selects High-Edge pulse (highlighted when selected).
-  500ps Selects 500ps-Edge pulse (highlighted when selected).
-  Fast Selects Fast Edge pulse (highlighted when selected).
- CHANNEL SELECT Permits the screen signal setup to be routed to any of the five heads, allowing selection of trigger channel, trigger ratio and cable channel (paras 4.5.3).
-  1. 2. 5. Press to select Direct Mode (paras 4.4.3/4).
-  1. 2. 5. Press to select Scope Mode (setting the step sequence to '1, 2, 5' or '1, 2, 2.5, 4, 5' as chosen using the Preferences key) (paras 4.4.1/2).

### 4.7.4 Edge Function Operation

#### 4.7.4.1 Value Editing

The section below assumes the use of a 9510 or 9530 Active Head. Operating output level and frequency boundaries vary for other Head types, Refer *para 7.4.1*.

##### Amplitude

At maximum and minimum output voltages, the screen settings of the contributors' values (units/division, scaling multiplier and deviation) are limited by the output voltage itself (refer to Table 4.7.4.1).

	9510 or 9530 Heads (High Edge) Frequency: 10Hz - 100kHz		500ps Edge & Fast Edge Frequency: 10Hz - 2MHz	
	Minimum	Maximum	Minimum	Maximum
Output Voltage Limit	888mV p-p	5.56V p-p	4.44mV p-p	3.10V p-p
Units/Division	0.2V/div	2V/div	1mV/div	1V/div
Scaling Multiplier	1	5	1	10
Deviation	-11.20%	+11.20%	-11.20%	+11.20%

Table 4.7.4.1 Edge Function — Output Voltage Limits and Contributors Limits

Provided they do not exceed the output voltage limits shown, the contributors have the following adjustments (Scope mode):

- a. Units/Division in Volts/division (adjustable sequence: 1-2-5 or 1-2-2.5-4-5; defaults: High Edge: 1V, others: 0.2V).
- b. Scaling Multiplier (adjustable through integers - High Edge: 1 to 5; default 5, others 1 to 10; default 5).
- c. Percentage Deviation (a maximum range of  $\pm 11.20\%$  about the value of (a) x (b), at a resolution of four significant digits, with two decimal places; default zero). Digit or direct edit can be used.
- d. Output Voltage (adjustable in digit edit only, by manipulation of (a), (b) and (c); defaults: High Edge: 5V, others: 1V).





#### 4.7.4.2 Output Voltage Editing

The 'Digit' and 'Direct' editing processes follow the same general rules as for editing voltages described in *paras 4.4*.

##### Tab Key and Cursors (Scope Mode)

Repeatedly pressing this key moves the cursor from the default Units/Division to the Multiplier, then Deviation, finally to the Frequency and back to the Units/Division. The type of cursor at each position indicates the type of adjustment possible to that value.

##### Units/Division (Scope Mode)

The type of cursor (barred) used for the units/division signifies that the value can be adjusted only as a step-sequence value using the  and  keys. The  and  keys are inactive.



#### 500ps Edge and Fast Edge

From the default '0.2V/div', the value can be raised using the  $\odot$  key up through 0.5V/div and so on to 1V/div, providing that the other contributors will not take the output voltage value above 3.00Vp-p. Similarly, the  $\ominus$  key will reduce the Units/Division down through 0.1V/div and so on to 1mV/div, unless the output voltage would fall below 4.44mVp-p (all frequencies).

#### High Edge

For High Edge the default is '1V/div', the upper limit is 2V/div (O/P Ampl. limit for 1M $\Omega$  load 5.56Vp-p). The lower limit is 0.2V/div to 1mV/div, (O/P Ampl. limit 888mVp-p).

#### Multiplier (Scope Mode)

##### 500ps Edge, Fast Edge and High Edge

Again the  $\leftarrow$  and  $\rightarrow$  keys are inactive.

From the default 'x5', the value can be changed using the  $\odot$  and  $\ominus$  keys, by single integer increments to values between 1 and 10, within output voltage value limits. The product of the units/division and multiplier are shown on the right side of the '=' sign.

#### Deviation (Scope and Direct Mode)

The triangular type of cursor indicates that all the cursor keys can be used as in other functions.

From the default 00.00%, the deviation percentage can be changed to any value within its resolution between -11.20% and +11.20%, within output voltage value limits. The result of combining the units/division, multiplier and deviation are shown as the p-p value of 'O/P Amplitude'.

#### Output Voltage (Scope and Direct Mode)

The O/P Amplitude is only adjustable by means of its contributors.

#### 500ps Edge and Fast Edge

From the default 1.0000V p-p, the output voltage can be changed to any value within its resolution between 4.44mVp-p and 3.0000Vp-p. The software ensures that the contributors' values remain within their limits.

#### High Edge

From the default 5.0000V p-p, the output voltage can be changed to any value within its resolution between 888mVp-p and 5.56Vp-p (1M $\Omega$  expected load only). The software ensures that the contributors' values remain within their limits.

#### Frequency (Scope and Direct Mode)

##### 500ps Edge and Fast Edge

From the default 1MHz, the output frequency can be changed to any value within its resolution between 10Hz and 2MHz.

#### High Edge

From the default 1kHz, the output frequency can be changed to any value within its resolution between 10Hz and 100kHz.

#### Rise (Fall) Time (Scope and Direct Mode)

When each head is calibrated, its measured (10% to 90%) transition times for each type of edge are stored in non-volatile memory. During normal use, this figure is recalled and presented on the 'Rise Time' field for the selected head (channel) and selected type of edge.

#### 4.7.4.3 Low Voltage (LV) and High Voltage (HV) States

Entering and leaving High Voltage state in High Edge Function is governed by the same rules as for Square function (refer to *para 4.5.5.3*). The threshold-setting limits are  $\pm 10$ Vpk-pk and  $\pm 110$ Vpk-pk.

## 4.7.5 Using Active Heads

### 4.7.5.1 Introduction

Active heads are introduced briefly in *paras 4.2.2 (Interconnections)*.

The front panel operations of Signal Channel selection, Trigger Channel selection, Cable selection and Trigger Ratio are described earlier in *paras 4.5.3 (DC/Square function)*.

*Final Width = 215mm*

Final Width = 215mm

## 4.7.6 Using the 9500B Edge Function to Calibrate the Pulse Response of a UUT Oscilloscope

### 4.7.6.1 Introduction

Two types of procedures for pulse response calibration use the 9500B as a fixed source, where the oscilloscope can or cannot be adjusted.

### 4.7.6.2 Interconnections

- a. Use the appropriate active head to connect from the required 9500B channel output to the input of the UUT Signal Channel to be calibrated.
- b. If a trigger is required, use the appropriate active head (or trigger cable) to connect from the required 9500B channel output to the input of the UUT Trigger for the Channel to be calibrated.

### 4.7.6.3 Common Setup

The following procedures assume that the 9500B instrument is in Manual Mode. It is also assumed that the user will be familiar with the methods of editing screen values. In the case of difficulty, re-read the *paragraphs earlier in this Section 4*.

#### 9500B and UUT Oscilloscope Setup

##### 1. Preparation

Ensure that both instruments are powered ON and warmed up.

##### 2. UUT 'Scope

Select the required function for pulse response calibration.

##### 3. 9500B

Ensure that the 9500B is in Edge Function with Output OFF. If in any other function, press the  key at the right of the front panel.

### 4.7.6.4 UUT Scope — Pulse Response Calibration using the 9500B as a Fixed Source

#### Sequence of Operations

Refer to the table or list of UUT Oscilloscope flatness calibration points in the *UUT Oscilloscope Manufacturer's Calibration Guide*.

Follow the sequence of calibration stages as directed by the guide, and carry out the following operations (1) to (6) at each stage.

##### 1. 9500B

Use the front panel controls to set the 9500B Output to the required edge p-p voltage, frequency and load impedance for the UUT 'Scope pulse response cal point:

##### 2. UUT 'Scope

- a. Select the correct channel for the cal point.
- b. Select the correct range for the cal point.

##### 3. 9500B Set Output ON.

##### 4. UUT 'Scope

- a. Adjust the sweep speed and trigger level for a stable display.
- b. Observe and note the pulse shape response.

##### 5. Calibration

- a. If a calibration adjustment is provided, adjust the UUT's pulse shape. Note rise time and aberration, as detailed in the *UUT Oscilloscope Manufacturer's Calibration Guide*.
- b. If no adjustment is provided on the UUT 'Scope, note rise time and aberration, as detailed in the *UUT Oscilloscope Manufacturer's Calibration Guide*.

##### 6. 9500B Set Output OFF.

## 4.8 Time Markers Function

### 4.8.1 Introduction

This sub-section is a guide to the use of the 9500B for generating square waves and DC voltages for use for amplitude calibration of oscilloscopes.

For those users who require more detailed instructions for interconnections, and manipulating the front panel controls, refer to *sub-sections 4.2, 4.3 and 4.4*. Section 4.8 is divided into the following sub-sections:

4.8.1	Introduction .....	4.8-1
4.8.2	Default Settings .....	4.8-1
4.8.3	Menu Selections .....	4.8-1
4.8.3.1	Retained Channel Memory .....	4.8-1
4.8.3.2	Choosing a Waveshape .....	4.8-1
4.8.3.3	Right Side Screen Keys - Digit Edit .....	4.8-2
4.8.3.4	Right Side Screen Keys - Direct Edit .....	4.8-2
4.8.3.5	Bottom Screen Keys - Digit and Direct Edit .....	4.8-2
4.8.4	Time Markers Operation .....	4.8-2
4.8.4.1	Value Editing .....	4.8-2
4.8.4.2	Output Period Editing .....	4.8-3
4.8.4.3	Highlighted Marker Styles .....	4.8-3
4.8.5	Using the 9500B Time Markers Function to Calibrate the Time Base of a UUT Oscilloscope .....	4.8-4
4.8.5.1	Introduction .....	4.8-4
4.8.5.2	Interconnections .....	4.8-4
4.8.5.3	Common Setup .....	4.8-4
4.8.5.4	UUT Scope - Time Base Calibration using the 9500B as a Fixed Source .....	4.8-4
4.8.5.5	UUT Scope - Time Base Calibration using the 9500B as an Adjustable Source .....	4.8-4

### 4.8.2 Default Settings

When Manual mode is selected the system defaults into DC/Square function and shows the DC/Square function initial menu screen. Time Markers function can be accessed by pressing the **TIME** function key on the right of the 'OSCILLOSCOPE CALIBRATOR' panel. Whenever the **TIME** menu screen is opened, except on recovery from a standby period, it will appear with the following default settings, although some settings may have been made non-volatile (*refer to para 4.5.3.6*):

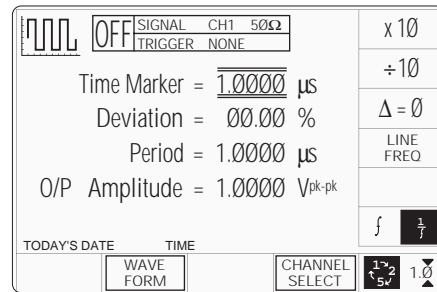

The above default screen has auto-selected the square waveform, as indicated by the icon in the top left corner. Square waveform Period is variable between 10ns and 50s (sine waveform is used above approx. 100MHz). Sine waveform Period is variable between 500ps and 10ns (variant 9500B/1100 — for other variants refer to specifications in *Section 7*). Period has defaulted to 1μs (square), deviation 'Δ' to zero, and output voltage to 1.0000Vp-p. The Duty Cycle is fixed at a nominal 50%.

### 4.8.3 Menu Selections

Signal Channel selection, Trigger Channel selection, Cable selection and Trigger Ratio all operate in the same way as in DC/Square function. Refer to *paras 4.5.3*.

### 4.8.3.1 Retained Channel Memory

Refer to *para 4.5.3.6*.

### 4.8.3.2 Choosing a Waveshape

All waveshapes (Marker Styles) in this function can be selected on a second menu screen. This is activated by pressing the 'WAVEFORM' screen key on the bottom row. The screen changes to show the available waveforms:

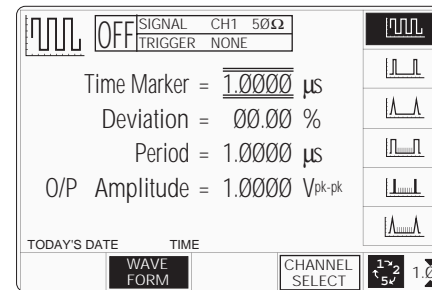

The WAVEFORM key label is highlighted to indicate that waveform selection is available, as is the presently-selected waveform icon.

Pressing one of the waveform keys (for example: the **WAVEFORM** key) to select a different waveform will return to the previous screen (providing that the frequency is appropriate), with the icon of the selected waveform showing in the top left corner:

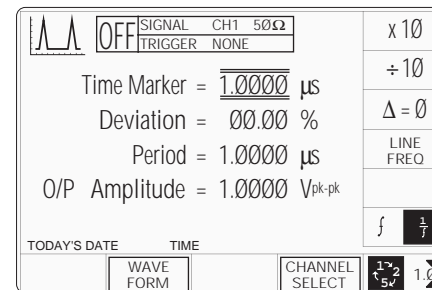

*Final Width = 215mm*

Final Width = 215mm

#### 4.8.3.3 Right Side Screen Keys — Digit Edit

Keys operate on the value marked by the cursor. The key labels will change depending on the cursor position, as indicated.:

- i. Cursor on any parameter:**
  - $\Delta = \emptyset$  Toggles the Deviation value between the marked value and zero.
  - LINE FREQ Line frequency output is available only for 'Square' waveform selection. The key toggles between internal Period/Frequency and the Line input Frequency.
- ii. Cursor on Time Marker:**
  - X10 Multiplies the displayed value by ten.
  - +10 Divides the displayed value by ten.
  - Press to change display from Period to Frequency.
  - Press to change display from Frequency to Period.
- iii. Cursor on Deviation:**
  - $\Delta\%$   $\Delta S$  Press to set Time Marker Deviation value in absolute units.
  - $\Delta\%$   $\Delta S$  Press to set Time Marker Period Deviation value in percent of Time Marker Period value.
- iv. Cursor on O/P Amplitude:**

See (i) above.

#### 4.8.3.4 Right Side Screen Keys — Direct Edit

Right side screen keys operate on the value in the edit box, and acting in place of the  $\downarrow$  key, exit from Direct Edit back to Digit Edit; then set the value as evaluated in the box:

- Cursor on Deviation:**
- % Evaluates the number in the box in **Period Deviation Percentage**.
  - s Evaluates the number in the box in **Seconds**.
  - ms Evaluates the number in the box in **Milliseconds**.
  - $\mu$ s Evaluates the number in the box in **Microseconds**.
  - ns Evaluates the number in the box in **Nanoseconds**.

#### 4.8.3.5 Bottom Screen Keys — Digit and Direct Edit

- WAVE FORM Provides a second menu screen for selection between three Time Marker waveshapes or their highlighted versions. (*paras 4.8.4.3*).  
With output on, the output to the UUT is grounded, for any waveform or DC selection.
- CHANNEL SELECT Permits the screen signal setup to be routed to any of the five heads, allowing selection of trigger channel, trigger ratio and cable channel (*paras 4.5.3*).
- Press to select Direct Mode (*paras 4.4.3/4*).
- Press to select Scope Mode (setting the step sequence to '1, 2, 5' or '1, 2, 2.5, 4, 5' as chosen using the Preferences key) (*paras 4.4.1/2*).

### 4.8.4 Time Markers Operation

#### 4.8.4.1 Value Editing

##### Output Period/Frequency

At maximum and minimum output period, the screen settings of the contributors' values (Time Marker and Deviation) are limited by both the output period/frequency and the output voltage. For example:

Marker Style	O/P Amplitude	Time Marker Period		Deviation		O/P Period	
		Min	Max	Min	Max	Min	Max
	100mV - 500mV	450.46ps	50s	-45%	+45%	450.46ps	55s
	1V	626.96ps	50s	-45%	+45%	909.10ps	55s
	100mV - 1V	621.32ns	50s	-45%	+45%	900.91ns	55s
	100mV - 1V	621.32ns	50s	-45%	+45%	900.91ns	55s
	100mV - 1V	13.794ns	50s	-45%	+45%	20.000ns	55s
	100mV - 1V	621.32ns	50s	-45%	+45%	20.000ns	55s
	100mV - 1V	621.32ns	50s	-45%	+45%	20.000ns	55s

Provided they do not exceed the O/P Period limits shown, the contributors have the following adjustments (Scope mode):

- Time Marker Period (adjustable sequence: 1-2-5 or 1-2-2.5-4-5; default 1.0000 $\mu$ s).
- Percentage Deviation (a maximum range of  $\pm 45.00\%$  about the value of (a), at a resolution of four significant digits, with two decimal places; default zero). Digit or direct edit can be used.
- Output Voltage (directly adjustable only by preferred sequence between 100mV and 1V; default 1.0000V).





#### 4.8.4.2 Output Period Editing



The 'Digit' and 'Direct' editing processes follow the same general rules as for editing voltages described in *paras 4.4*.

#### Tab Key and Cursors (Scope Mode)

Repeatedly pressing this key moves the cursor from the default 'Time Marker' (period) to the Deviation, then to the O/P Amplitude and back to the 'Time Marker' position. The type of cursor at each position indicates the type of adjustment possible.

#### Time Marker (Scope Mode)

The type of cursor (barred) used for the 'Time Marker' signifies that the value can be adjusted only as a step-sequence value using the  and  keys. The  and  keys are inactive.

From the default '1 $\mu$ s', the 'Time Marker' period can be raised using the  key by increments through 2 $\mu$ s, 5 $\mu$ s, 10 $\mu$ s and so on up to 50s, providing that the other contributors will not make the output period longer than 55s. Similarly, the  key will reduce the 'Time Marker' period down to 500ps, unless the output voltage is greater than 500mV.

#### Square/Sine Waveform Changeover

The changeover from square to sine occurs at a frequency of 111.101MHz (Period = 9.000819ns), chosen to avoid normal calibration points.

#### Frequency Parameter Resolution Conflict

Due to resolution and the step sequence, some periods cannot be converted exactly into frequencies. In order to direct attention towards **period** at any point at which its reciprocal cannot be defined exactly, the 'Frequency' parameter display is given an 'approximately equal to' symbol ( $\approx$ ).

#### Deviation (Scope and Direct Mode)

**Note:** In **Time Markers** function, the **Deviation** operates on the **Time Marker** interval, to modify the output **'Period'** or **'Frequency'**, and **not** modify the O/P Amplitude, as in the other functions.

The triangular type of cursor indicates that all the cursor keys can be used.

The result of combining the Time Marker interval and Deviation are shown as the value of the output 'Period' or 'Frequency'. From the default 00.00%, the deviation percentage can be changed to any value within its resolution between -45% and +45%, providing that the Time Marker interval does not take the output 'Period' or 'Frequency' value out of its limits.

#### Output Voltage Amplitude (Scope and Direct Mode)

The O/P Amplitude is directly adjustable, but only in the step sequence defined by the preferences (**Pref**) facility. For this reason the O/P Amplitude has a 'barred' cursor in both Scope and Direct modes.







The default 1.0000Vp-p is the maximum output available. The output voltage can be changed to any step value between 100mV p-p and 1V p-p. With Marker Style , for sinewave periods less than 909.09ps, the maximum output voltage available is 500mVp-p.

#### Output Period/Frequency

From the default 1 $\mu$ s/1MHz, the output period/frequency can be changed to any value within its limits as shown in the table for the Marker Styles.

#### 4.8.4.3 Highlighted Marker Styles

Each marker style is available in a version where each tenth marker is raised to higher amplitude (highlighted) for Output Periods of 1 $\mu$ s and longer:

-  Square/Sine: symbol for highlighted style is  (does not extend into Sine frequency band).
-  Pulse: symbol for highlighted style is .
-  Narrow Triangle: symbol for highlighted style is .

Limits for these highlighted versions are shown in the table.

*Final Width = 215mm*

Final Width = 215mm

## 4.8.5 Using the 9500B Time Markers Function to Calibrate the Time Base of a UUT Oscilloscope

### 4.8.5.1 Introduction

Two types of procedures for time base calibration are given:

- a. Using the 9500B as a fixed source, where the oscilloscope can be adjusted or a measurement can be taken;
- b. Using the 9500B as an adjustable source, reading oscilloscope deviations via the 9500B screen.

### 4.8.5.2 Interconnections

- a. Use an active head to connect from the required 9500B channel output to the input of the UUT Signal Channel to be calibrated.
- b. If a trigger is required, use an active head (or trigger cable) to connect from the required 9500B channel output to the input of the UUT Trigger for the Channel to be calibrated.

### 4.8.5.3 Common Setup

The following procedures assume that the 9500B instrument is in Manual Mode. It is also assumed that the user will be familiar with the methods of editing screen values. In the case of difficulty, re-read the *paragraphs earlier in this Section 4*.

#### 9500B and UUT Oscilloscope Setup

##### 1. Preparation

Ensure that both instruments are powered ON and warmed up.

##### 2. UUT 'Scope

Select the required function for time base calibration.

##### 3. 9500B

Ensure that the 9500B is in Time Markers Function with Output OFF. If in any other function, press the **||||** key at the right of the front panel.

### 4.8.5.4

#### UUT Scope — Time Base Calibration using the 9500B as a Fixed Source

##### Sequence of Operations

Refer to the table or list of UUT Scope time base calibration points in the *UUT Oscilloscope Manufacturer's Calibration Guide*.

Follow the sequence of calibration stages as directed by the guide, and carry out the following operations (1) to (6) at each stage.

##### 1. 9500B

Use the front panel controls to set the 9500B output to the required channel, expected load impedance, trigger channel, waveshape, period and p-p voltage for the UUT 'Scope time base cal point:

##### 2. UUT 'Scope

- a. Select the correct channel for the cal point.
- b. Select the correct time base speed for the cal point.
- c. Select the correct amplitude range for the cal point.

##### 3. 9500B Set Output ON.

##### 4. UUT 'Scope

- a. Adjust the sweep speed and trigger level for a stated display.
- b. Observe and note the accuracy of marker alignment, indicating any misadjustment in the UUT's time base speed or linearity.

##### 5. Calibration

- a. If calibration adjustments for time base speed and linearity are provided, adjust the UUT's time base to be appropriate to the settings on the 9500B screen, as detailed in the *UUT Oscilloscope Manufacturer's Calibration Guide*.
- b. If no adjustment is provided on the UUT 'Scope, record the timebase condition at the calibration point as detailed in the *UUT Oscilloscope Manufacturer's Calibration Guide*.

##### 6. 9500B Set Output OFF.

### 4.8.5.5

#### UUT Scope — Time Base Calibration, the 9500B as an Adjustable Source

##### Sequence of Operations

Refer to the table or list of UUT Scope time base calibration points in the *UUT Oscilloscope Manufacturer's Calibration Guide*.

Follow the sequence of calibration stages as directed by the guide, and carry out the following operations (1) to (6) at each stage.

##### 1. 9500B

Use the front panel controls to set the 9500B output to the required channel, expected load impedance, trigger channel, waveshape, period and p-p voltage for the UUT 'Scope time base cal point:

##### 2. UUT 'Scope

- a. Select the correct channel for the cal point.
- b. Select the correct time base speed for the cal point.
- c. Select the correct amplitude range for the cal point.

##### 3. 9500B Set Output ON.

##### 4. UUT 'Scope

- a. Adjust the sweep speed and trigger level for a stated display.
- b. Observe and note the accuracy of marker alignment, indicating any misadjustment in the UUT's time base speed or linearity.

##### 5. Calibration

- a. Use the 9500B Deviation control to slew the 9500B Output period/frequency until the UUT's alignment is appropriate to the 9500B settings, as detailed in the *UUT Scope Manufacturer's Calibration Guide*.
- b. Record the 9500B screen output voltage and period/frequency as detailed in the *UUT Oscilloscope Manufacturer's Calibration Guide*.

##### 6. 9500B Set Output OFF.

## 4.9 Auxiliary Functions

### 4.9.1 Introduction

This sub-section is a guide to selecting the Auxiliary Functions. Eight functions are available.

### 4.9.2 Selection of Auxiliary Functions

#### 4.9.2.1 'Aux' Key

Auxiliary functions are accessed by pressing the 'Aux' key at the right of the 'OSCILLOSCOPE CALIBRATOR' panel.





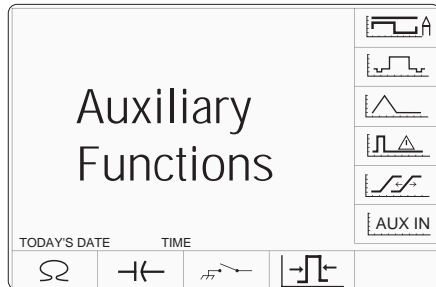





#### 4.9.2.2 Default Settings

At power-on, the system defaults into DC/Square function and shows the DC/Square function initial menu screen.. Each time the 'Aux' key is pressed, the system defaults to show the Auxiliary menu screen:



#### 4.9.2.3 Function Icons

The following icons are used to access the functions listed:

		<i>Sub Sect:</i>
	Current;	4.10
	Composite Video;	4.11
	LF Linear Ramp;	4.12
	Overload Pulse;	4.13
	Zero Skew;	4.14
	(Without Option 5, only one signal channel and one trigger channel is available, so Zero Skew operation is not possible.)	
	Auxiliary Input;	4.15
	Input Resistance Measurement;	4.16
	Input Capacitance Measurement;	4.16
	Short/Open Output.	4.17
	Pulse Width	4.18

*Final Width = 215mm*

BLANK PAGE (LEFT-HAND)



## 4.10 Current Function

### 4.10.1 Introduction

This sub-section is a guide to the use of the 9500B for generating square waves and DC currents for use in calibrating oscilloscope current probes.

For those users who require more detailed instructions for interconnections, and manipulating the front panel controls, refer to *sub-sections 4.2, 4.3 and 4.4*. Section 4.10 is divided into the following sub-sections:

4.10.1	Introduction .....	4.10-1
4.10.2	Current Probe Accessory .....	4.10-1
4.10.3	Default Settings .....	4.10-1
4.10.4	Menu Selections .....	4.10-2
4.10.4.1	Retained Channel Memory .....	4.10-2
4.10.4.2	Choosing a Waveshape .....	4.10-2
4.10.4.3	DCI Selection .....	4.10-2
4.10.4.4	Current Selection Summary .....	4.10-2
4.10.5	Current Operation .....	4.10-2
4.10.5.1	Right Side Screen Keys - Digit Edit .....	4.10-2
4.10.5.2	Right Side Screen Keys - Direct Edit .....	4.10-3
4.10.5.3	Bottom Screen Keys - Digit and Direct Edit .....	4.10-3
4.10.6	Square Operation .....	4.10-3
4.10.6.1	Value Editing .....	4.10-3
4.10.6.2	Output Current Editing .....	4.10-3
4.10.7	Using the 9500B Current (Square) Function to Calibrate the Amplitude Response of a UUT Oscilloscope .....	4.10-4
4.10.7.1	Introduction .....	4.10-4
4.10.7.2	Interconnections .....	4.10-4
4.10.7.3	Common Setup .....	4.10-4
4.10.7.4	UUT Scope - Amplitude Calibration using the 9500B as a Fixed Source .....	4.10-4
4.10.7.5	UUT Scope - Amplitude Calibration using the 9500B as an Adjustable Source .....	4.10-5
4.10.8	DCI Operation .....	4.10-5
4.10.8.1	Polarity .....	4.10-5
4.10.8.2	Value Editing .....	4.10-5
4.10.8.3	Output Current Editing .....	4.10-5
4.10.9	Using the 9500B DCI Function to Calibrate the DC-Coupled Amplitude Response of a UUT Oscilloscope .....	4.10-6
4.10.9.1	Introduction .....	4.10-6
4.10.9.2	Interconnections .....	4.10-6
4.10.9.3	Common Setup .....	4.10-6
4.10.9.4	UUT Scope - DC-Coupled Amplitude Calibration using the 9500B as a Fixed Source .....	4.10-6
4.10.9.5	UUT Scope - DC-Coupled Amplitude Calibration using the 9500B as an Adjustable Source .....	4.10-7

### 4.10.2 Current Probe Accessory

This sub-section describes the accessory which is used to terminate the 9500B output, and activate UUT Oscilloscope current probe.

The accessory consists of a BNC male connector which is plugged into the BNC output female socket on any model head. A loop is connected between the BNC center and shell, which is available for insertion into the recess of an oscilloscope current probe. The loop presents 50Ω loading to the head:

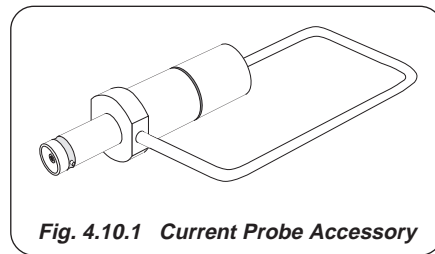



Fig. 4.10.1 Current Probe Accessory

With the 9500B 'Auxiliary' Current function selected and output on, the output current in the loop can be set to the UUT oscilloscope's current probe calibration points, using 9500B front panel controls.

### 4.10.3 Default Settings

When Manual mode is selected the system defaults into DC/Square function and shows the DC/Square function initial menu screen. The Current function is accessed by first pressing the 'Aux' key on the right of the 'OSCILLOSCOPE CALIBRATOR' panel, then pressing the  soft key on the top right of the screen.

Whenever the Current menu screen is opened, except on recovery from a standby period, it will appear with the following default settings:

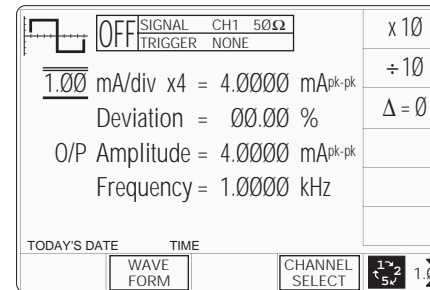

The above default screen has auto-selected the symmetrical square waveform, as indicated by the icon in the top left corner. Frequency is variable between 10.000Hz and 100.00kHz. Frequency has defaulted to 1kHz, deviation 'Δ' to zero, and output current to 4.0000mA<sub>p-p</sub>. The Duty Cycle is fixed at a nominal 50%.

Final Width = 215mm

#### 4.10.4 Menu Selections

Signal Channel selection, Trigger Channel selection, Cable selection and Trigger Ratio all operate in the same way as in DC/Square function. Refer to *paras 4.5.3*.

**Note:** Without Option 5, only one signal channel and one trigger channel is available.

##### 4.10.4.1 Retained Channel Memory

Refer to *para 4.5.3.6*.

##### 4.10.4.2 Choosing a Waveshape

All waveshapes in this function can be selected on a second menu screen. This is activated by pressing the 'WAVEFORM' screen key on the bottom row. The screen changes to show the available waveforms:

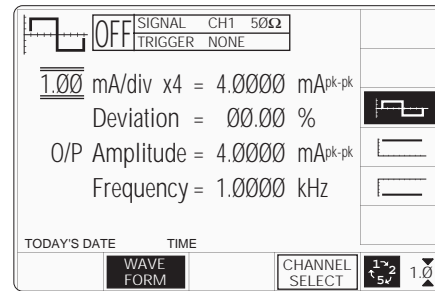

The WAVEFORM key label is highlighted to indicate that waveform selection is available, as is the presently-selected waveform icon.

The only *square* current waveform available is the symmetrical version, so the others shown on this screen are for *DC* current. Selecting any of these three will return to the previous screen, with the icon of the selected waveform showing in the top left corner:

Final Width = 215mm

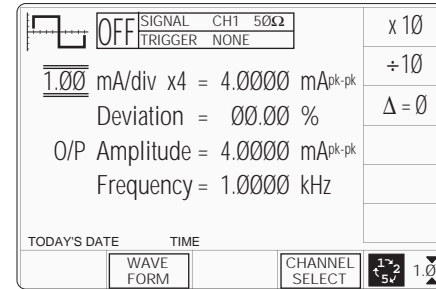

##### 4.10.4.3 DCI Selection

Pressing one of the two DC keys, for example: the  (DC Negative) key, will return to the previous screen, with the DC Negative icon showing in the top left corner. The parameters listed on the screen will be changed to reflect DC instead of Square:

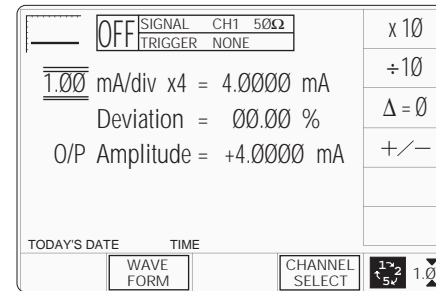

##### 4.10.4.4 Current Selection Summary

'DC' and 'Square' can be regarded as a combined dual function, as each has a similar purpose, and switching between the two is accomplished by selection in a common 'Waveform' menu.

The parametric differences are evident once the appropriate waveform soft key has been pressed.





Detailed operation follows below:

- paras 4.10.5 (Current Operation)*
- paras 4.10.6/7 (Square Operation)*
- paras 4.10.8/9 (DCI Operation).*

#### 4.10.5 Current Operation

##### 4.10.5.1 Right Side Screen Keys — Digit Edit

Keys operate on the value marked by the cursor. The key labels will change depending on the cursor position, as indicated.:

- i. Cursor on Units/div:**
  - X10 Multiplies the Units/div by ten.
  - ÷10 Divides the Units/div by ten.
  - Δ = 0 Toggles the Deviation value between the marked value and zero.
  - +/- Toggles the value between positive and negative (DC only).
- ii. Cursor on Multiplier:**
  - Δ = 0 Toggles the Deviation value between the marked value and zero.
  - +/- Toggles the value between positive and negative (DC only).
- iii. Cursor on Deviation:**
  - Δ = 0 Toggles the Deviation value between the marked value and zero.
  -  ΔA Press to set Deviation value in absolute units.
  -  ΔA Press to set Deviation value in percent of set value.
- iv. Cursor on Frequency/Period:**
  - X10 Multiplies the marked value by ten.
  - ÷10 Divides the marked value by ten.
  - Δ = 0 Toggles the Deviation value between the marked value and zero.
  -   $\frac{1}{T}$  Press to change display from Frequency to Period (not DC).
  -   $\frac{1}{T}$  Press to change display from Period to Frequency (not DC).

#### 4.10.5.2 Right Side Screen Keys — Direct Edit

Right side screen keys operate on the value in the edit box, and acting in place of the ↵ key, exit from Direct Edit back to Digit Edit; then set the value as evaluated in the box:

##### Cursor on Deviation:

%	Evaluates the number in the box in <b>Deviation Percentage</b> .
A	Evaluates the number in the box in <b>Amps</b> .
mA	Evaluates the number in the box in <b>Milliamps</b> .
µA	Evaluates the number in the box in <b>Microamps</b> .

#### 4.10.5.3 Bottom Screen Keys — Digit and Direct Edit

WAVE FORM Provides a second menu screen for selection between three Square waveshapes or ±DC. (*paras 4.10.4.2-3*).

CHANNEL SELECT Permits the screen signal setup to be routed to any of the five heads, allowing selection of trigger channel, trigger ratio and cable channel (*paras 4.5.3*).

 Press to select Direct Mode (*paras 4.4.4/5*).

 Press to select Scope Mode (setting the step sequence to '1, 2, 5' or '1, 2, 2.5, 4, 5' as chosen using the Preferences key) (*paras 4.4.1/2*).

### 4.10.6 Square Operation

#### 4.10.6.1 Value Editing

##### Amplitude

At maximum and minimum output currents, the screen settings of the contributors' values (units/division, scaling multiplier and deviation) are limited by the output current itself. For example:

Contributor	Limits	
	Minimum	Maximum
Output Current Limit	88.8µA p-p	111.2mA p-p
Units/Division	20µA/div	50mA/div
Scaling Multiplier	1	10
Deviation	-11.20%	+11.20%

Provided they do not exceed the output current limits shown, the contributors have the following adjustments (Scope mode):

- Units/Division in Amps/division (adjustable sequence: 1-2-5 or 1-2-2.5-4-5; default 1mA).
- Scaling Multiplier (adjustable through integers 1 to 10; default 4).
- Percentage Deviation (a maximum range of ±11.20% about the value of (a) x (b), at a resolution of four significant digits, with two decimal places; default zero). Digit or direct edit can be used.
- Output Current (adjustable only by manipulation of (a), (b) and (c); default 4.0000mA).





#### 4.10.6.2 Output Current Editing



The 'Digit' and 'Direct' editing processes follow the same general rules as for editing currents described in *paras 4.4*.

##### Tab Key and Cursors (Scope Mode)





Repeatedly pressing this key moves the cursor from the default units/division to the Multiplier, then to the Deviation and back to the units/division. The type of cursor at each position indicates the type of adjustment possible.

##### Units/Division (Scope Mode)

The type of cursor (barred) used for the units/division signifies that the value can be adjusted only as a step-sequence value using the  and  keys. The  and  keys are inactive.

From the default '1mA/div', the value can be raised using the  key by increments through 2mA/div, 5mA/div, 10mA/div and so on up to 50mA/div, providing that the other contributors will not take the output current value above 111.2mA p-p. Similarly, the  key will reduce the Units/Division down to 20µA/div, unless the output current would fall below 88.8µA p-p.

##### Multiplier (Scope Mode)

Again the  and  keys are inactive. From the default 'x 4', the value can be changed using the  and  keys, by single integer increments to values between 1 and 10, providing that the other contributors do not take the output current value out of its limits. The product of the units/division and multiplier are shown on the right side of the '=' sign.

*Final Width = 215mm*

*continued overleaf →*

Final Width = 215mm

#### 4.10.6 Square Operation (Contd.)

##### 4.10.6.2 Output Current Editing (Contd.)

###### Deviation (Scope and Direct Mode)

The triangular type of cursor indicates that all the cursor keys can be used.

From the default 00.00%, the deviation percentage can be changed to any value within its resolution between -11.20% and +11.20%, providing that the other contributors do not take the output current value out of its limits. The result of combining the units/division, multiplier and deviation are shown as the value of 'O/P Amplitude p-p'.

###### Output Current (Scope and Direct Mode)

The O/P Amplitude is only adjustable by means of its contributors.

From the default 4.0000mA p-p, the output current can be changed to any value within its resolution from 88.8µA p-p to 111.2mA p-p.

###### Frequency (Scope and Direct Mode)

From the default 1kHz, the output frequency can be changed to any value within its resolution between 10Hz and 100kHz.

#### 4.10.7 Using the 9500B Current (Square) Function to Calibrate the Pulse Response of a UUT Oscilloscope Current Probe

##### 4.10.7.1 Introduction

Two types of procedures for amplitude calibration are given:

- Using the 9500B as a fixed source, where the oscilloscope can be adjusted;
- Using the 9500B as an adjustable source, reading oscilloscope deviations via the 9500B screen.

##### 4.10.7.2 Interconnections

- Use the appropriate active head and current probe accessory to connect from the required 9500B signal output channel to the UUT current probe.
- If a trigger is required, use the appropriate active head (or trigger cable) to connect from the required 9500B channel output to the scope input.

##### 4.10.7.3 Common Setup

The following procedures assume that the 9500B instrument is in Manual Mode. It is also assumed that the user will be familiar with the methods of editing screen values. In the case of difficulty, re-read the *paragraphs earlier in this Section 4*.

##### 9500B and UUT Oscilloscope Setup

###### 1. Preparation

Ensure that both instruments are powered ON and warmed up.

###### 2. UUT Probe

Select the required function for probe pulse response calibration.

###### 3. 9500B

Ensure that the 9500B is in Current Function with Output OFF. If in any other function, press the 'Aux' key on the right of the 'OSCILLOSCOPE CALIBRATOR' panel, then the  soft key on the top right of the screen.

##### 4.10.7.4

##### UUT Current Probe — Pulse Response Calibration using the 9500B as a Fixed Source

###### Sequence of Operations

Refer to the table or list of UUT Oscilloscope amplitude calibration points in the *UUT Oscilloscope Manufacturer's Calibration Guide*.

Follow the sequence of calibration stages as directed by the guide, and carry out the following operations (1) to (6) at each stage.

###### 1. 9500B

Use the front panel controls to set the 9500B Output to the required square wave p-p current and frequency for the UUT 'Scope amplitude cal point:

###### 2. UUT 'Scope

- Select the correct channel for the cal point.
- Select the correct range for the cal point.

###### 3. 9500B Set Output ON.

###### 4. UUT 'Scope

- Adjust the sweep speed and trigger level for a stable display.
- Observe and note the amplitude response.

###### 5. Calibration

- If a calibration adjustment is provided, adjust the probe's response to be appropriate to the settings on the 9500B screen, as detailed in the *UUT Oscilloscope Manufacturer's Calibration Guide*.
- If no adjustment is provided, record the probe's response at the calibration point as detailed in the *UUT Oscilloscope Manufacturer's Calibration Guide*.

###### 6. 9500B Set Output OFF.

#### 4.10.7.5

### UUT Current Probe — Pulse Response Calibration using the 9500B as an Adjustable Source

#### Sequence of Operations

Refer to the table or list of UUT Oscilloscope amplitude calibration points in the *UUT Oscilloscope Manufacturer's Calibration Guide*.

Follow the sequence of calibration stages as directed by the guide, and carry out the following operations (1) to (6) at each stage.

#### 1. 9500B

Use the front panel controls to set the 9500B Output to the required square wave p-p current and frequency for the UUT 'Scope amplitude cal point:

#### 2. UUT 'Scope

- Select the correct channel for the cal point.
- Select the correct range for the cal point.

#### 3. 9500B Set Output ON.

#### 4. UUT 'Scope

- Adjust the sweep speed and trigger level for a stable display.
- Observe and note the amplitude response.

#### 5. Calibration

- Use the 9500B Deviation control to slew the 9500B Output current until the UUT's response is appropriate to the 9500B settings, as detailed in the *UUT Oscilloscope Manufacturer's Calibration Guide*.
  - Record the 9500B screen output current as detailed in the *UUT Oscilloscope Manufacturer's Calibration Guide*.
6. **9500B** Set Output **OFF**.

### 4.10.8 DCI Operation

#### 4.10.8.1 Polarity

##### Waveform Selection Screen

From the power-on default, pressing the **WAVEFORM** screen key transfers to the waveform menu screen:

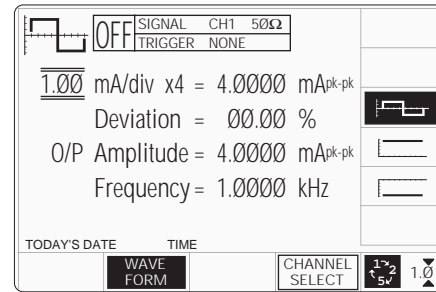

Both polarities of DC Current output are listed merely as different waveforms. As an example, pressing the  key from the setup shown above will present the DC function screen, showing negative values selected (of course, the frequency parameter has disappeared from the screen):

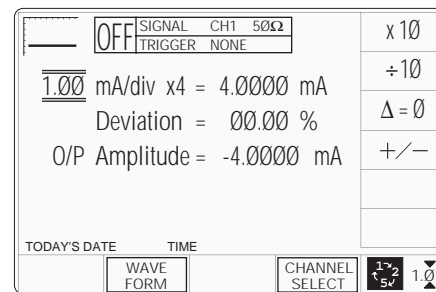

Once into DC function, it is not necessary to change the waveform to change polarity. Pressing the **+/-** screen key toggles between positive and negative DC Current. The polarity selection is shown by the function icon in the top left corner, confirmed by the **+** or **-** sign on the O/P Amplitude value.

#### 4.10.8.2 Value Editing

##### Amplitude

At maximum and minimum output currents, the screen settings of the contributors' values (units/division, scaling multiplier and deviation) are limited by the output current itself. For example:

Contributor	Limits	
	Minimum	Maximum
Output Current Limit	±88.8µA p-p	±11.2mA p-p
Units/Division	20µA/div	50mA/div
Scaling Multiplier	1	10
Deviation	-11.20%	+11.20%

Provided they do not exceed the output current limits shown, the contributors have the following adjustments (Scope mode):

- Units/Division in Volts/division (adjustable sequence: 1-2-5 or 1-2-2.5-4-5; default 1mA).
- Scaling Multiplier (adjustable through integers 1 to 10; default 4).
- Percentage Deviation (a maximum range of ±11.20% about the value of (a) x (b), at a resolution of four significant digits, with two decimal places; default zero). Digit or direct edit can be used.
- Output Current (adjustable in digit edit only, by manipulation of (a), (b) and (c); default 4.000mA).

#### 4.10.8.3 Output Current Editing

The 'Digit' and 'Direct' editing processes follow the same rules as for editing square waves (refer to *para 4.10.6.2*). Obviously no frequency adjustment is present, and polarity is changed as described in *para 4.10.8.1*.

*Final Width = 215mm*

Final Width = 215mm

## 4.10.9

### Using the 9500B DCI Function to Calibrate the Amplitude Response of a UUT Oscilloscope Current Probe

#### 4.10.9.1 Introduction

Two types of procedures for amplitude calibration are given:

- a. Using the 9500B as a fixed source, where the oscilloscope can be adjusted;
- b. Using the 9500B as an adjustable source, reading oscilloscope deviations via the 9500B screen.

#### 4.10.9.2 Interconnections

- a. Use the appropriate active head and current probe accessory to connect from the required 9500B signal output channel to the current probe at the UUT input.
- b. If a trigger is required, use the appropriate active head (or trigger cable) to connect from the required 9500B channel output to the UUT Trigger input.

#### 4.10.9.3 Common Setup

The following procedures assume that the 9500B instrument is in Manual Mode. It is also assumed that the user will be familiar with the methods of editing screen values. In the case of difficulty, re-read the *paragraphs earlier in this Section 4*.

#### 9500B and UUT Oscilloscope Setup



##### 1. Preparation

Ensure that both instruments are powered ON and warmed up.

##### 2. UUT Probe

Select the required function for pulse response calibration.

##### 3. 9500B

Ensure that the 9500B is in Current Function with Output OFF. If in any other function, press the 'Aux' key on the right of the 'OSCILLOSCOPE CALIBRATOR' panel, then the  soft key on the top right of the screen. Select  or  as required.

#### 4.10.9.4

#### UUT Current Probe — Amplitude Calibration using the 9500B as a Fixed Source

##### Sequence of Operations

Refer to the table or list of UUT Oscilloscope amplitude calibration points in the *UUT Scope Manufacturer's Calibration Guide*.

Follow the sequence of calibration stages as directed by the guide, and carry out the following operations (1) to (8) at each stage.

##### 1. 9500B

Use the front panel controls to set the 9500B Output to the required DC current and polarity for the UUT Probe amplitude cal point:

##### 2. UUT 'Scope

- a. Select the correct channel for the cal point.
- b. Select 'DC-Coupled', if required.
- c. Select the correct range for the cal point.

##### 3. 9500B

Ensure that Output is OFF.

##### 4. UUT 'Scope

- a. Set the Y controls to place the trace on graticule zero.

##### 5. 9500B

Set Output ON.

##### 6. UUT 'Scope

- a. Auto-trigger the oscilloscope or use the 100Hz Trigger from the 9500B. Adjust the UUT for a stable display.
- b. Observe and note the DC level change from graticule zero.

#### 7. Calibration

- a. If a calibration adjustment is provided, adjust the UUT probe's amplitude response to be appropriate to the settings on the 9500B screen, as detailed in the *UUT Scope Manufacturer's Calibration Guide*.
- b. If no adjustment is provided, record the probe's amplitude response at the calibration point as detailed in the *UUT Scope Manufacturer's Calibration Guide*.

8. **9500B** Set Output OFF.

---

#### 4.10.9.5

### UUT Current Probe — Amplitude Calibration using the 9500B as an Adjustable Source

#### Sequence of Operations

Refer to the table or list of UUT Oscilloscope amplitude calibration points in the *UUT Scope Manufacturer's Calibration Guide*.

Follow the sequence of calibration stages as directed by the guide, and carry out the following operations (1) to (8) at each stage.

#### 1. 9500B

Use the front panel controls to set the 9500B Output to the required DC current and polarity for the UUT Probe amplitude cal point:

#### 2. UUT 'Scope

- a. Select the correct channel for the cal point.
- b. Select 'DC-Coupled', if required.
- c. Select the correct range for the cal point.

#### 3. 9500B

Ensure that Output is **OFF**.

#### 4. UUT 'Scope

- a. Set the Y controls to place the trace on graticule zero.

#### 5. 9500B

Set Output **ON**.

#### 6. UUT 'Scope

- a. Auto-trigger the oscilloscope or use the 100Hz Trigger from the 9500B. Adjust the UUT for a stable display.
- b. Observe and note the DC level change from graticule zero.

#### 7. Calibration

- a. Use the 9500B Deviation control to slew the 9500B Output current until the UUT probe's response is appropriate to the 9500B settings, as detailed in the *UUT Scope Manufacturer's Calibration Guide*.
  - b. Record the 9500B screen output current as detailed in the *UUT Scope Manufacturer's Calibration Guide*.
8. **9500B** Set Output **OFF**.

*Final Width = 215mm*

BLANK PAGE (LEFT-HAND)



## 4.11 Composite Video Function

### 4.11.1 Introduction

This sub-section is a guide to the use of the 9500B to generate composite video for video trigger sensitivity calibration of oscilloscopes. For those users who require more detailed instructions for interconnections, and manipulating the front panel controls, refer to *sub-sections 4.2, 4.3 and 4.4*. Section 4.11 is divided into the following sub-sections:

4.11.1 Introduction .....	4.11-1
4.11.2 Signals and Triggers .....	4.11-1
4.11.3 Default Settings .....	4.11-1
4.11.4 Menu Selections .....	4.11-1
4.11.4.1 Retained Channel Memory .....	4.11-1
4.11.4.2 Right Side Screen Keys .....	4.11-1
4.11.4.3 Bottom Screen Keys .....	4.11-1
4.11.5 Composite Video Function Operation .....	4.11-2
4.11.5.1 Value Editing .....	4.11-2
4.11.6 Using the 9500B Composite Video Function to Calibrate Video Trigger Sensitivity of a UUT Oscilloscope .....	4.11-2
4.11.6.1 Introduction .....	4.11-2
4.11.6.2 Interconnections .....	4.11-2
4.11.6.3 Calibration Procedure .....	4.11-2

### 4.11.2 Signals and Triggers

The composite video signal generated by the 9500B is standard 625 line or 525 line video with both frame and composite synch pulses, and an inverted version of the composite waveform is available. As shown by the screen icon, three luminance levels are available.

The 9500B trigger channel can output either composite or frame synchronizing pulses, without the video. All variants can be selected from the front panel.

### 4.11.3 Default Settings

When Manual mode is selected the system defaults into DC/Square function and shows the DC/Square function initial menu screen. The Composite Video function is accessed by first pressing the 'Aux' key on the right of the 'OSCILLOSCOPE CALIBRATOR' panel, then pressing the  soft key on the right of the screen.

Whenever the  menu screen is opened, except on recovery from a standby period, it will appear with the following default settings:

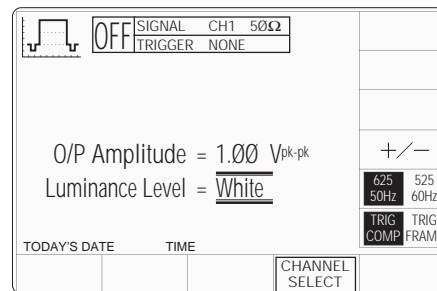

The above default screen has auto-selected 625 lines / 50Hz and triggers will be from composite video. Amplitude has defaulted to a luminance level of 'White' at 1.0V p-p.

### 4.11.4 Menu Selections

Signal Channel selection, Trigger Channel selection and Cable selection all operate in the same way as in DC/Square function. Trigger Ratio is not available in Composite Video function. Refer to *paras 4.5.3*.

**Note:** Without Option 5, only one signal channel and one trigger channel is available.

#### 4.11.4.1 Retained Channel Memory

Refer to *para 4.5.3.6*.

#### 4.11.4.2 Right Side Screen Keys

The cursor is available only on the Luminance Level parameter (Scope mode). Three luminance levels are defined (*para 4.11.5.1*). The key labels will change depending on other key selections:

##### Default Screen:

 Toggles between upright and inverted composite video.

 Currently 50Hz line supply with 625 raster lines. Press to select for 60Hz line supply with 525 raster lines.

 Currently 60Hz line supply with 525 raster lines. Press to select for 50Hz line supply with 625 raster lines.

 Currently Composite synch pulses on the Trigger channel. Press to output Frame synch pulses on the Trigger channel.

 Currently Frame synch pulses on the Trigger channel. Press to output Composite synch pulses on the Trigger channel.

#### 4.11.4.3 Bottom Screen Keys

 Permits the screen signal setup to be routed to any of the five heads, allowing selection of trigger channel and cable channel (*paras 4.5.3*).

*Final Width = 215mm*

Final Width = 215mm

## 4.11.5 Composite Video Function Operation

### 4.11.5.1 Value Editing

#### Amplitude

The three luminance levels give amplitudes as follows:

White	(1.0Vp-p),
Mid-grey	(0.7Vp-p)
Black	(0.3Vp-p).

#### Video Inversion

Composite Video can be toggled between upright and inverse, using the +/- screen key. No further adjustment is available.

#### Video Standards

Composite Video can be switched between 625 lines/50Hz and 525 lines/60Hz, using the  screen key.

#### Trigger Interval Selection

Either composite or frame synch can be selected as trigger on the assigned trigger channel, using the  screen key. The +/- key toggles the synch polarity as part of the composite video.

## 4.11.6 Using the 9500B Levelled Composite Video Function to Calibrate Video Trigger Sensitivity of a UUT Oscilloscope

### 4.11.6.1 Introduction

As the 9500B composite video amplitude variation is limited, and trigger outputs are not variable, except as described in *paras 4.11.5.1*, procedures for operating the 9500B are essentially simple:

### 4.11.6.2 Interconnections

- Use an active head to connect from the required 9500B channel output to the video input of the UUT Signal Channel to be calibrated.
- If a trigger is required, use an active head (or trigger cable) to connect from the required 9500B channel output to the input of the UUT Trigger for the Channel to be calibrated.

### 4.11.6.3 Calibration Procedure

The following procedure assumes that the 9500B instrument is in Manual Mode. It is also assumed that the user will be familiar with the methods of using front panel controls. In the case of difficulty, re-read the *paragraphs earlier in this Section 4*.

#### 9500B and UUT Oscilloscope Setup

##### 1. Preparation

Ensure that both instruments are powered ON and warmed up.

##### 2. UUT 'Scope

Select the required function for video and trigger calibration.

##### 3. 9500B

Ensure that the 9500B is in Composite Video Function with Output OFF. If in any other function, press the 'Aux' key on the right of the 'OSCILLOSCOPE CALIBRATOR' panel, then the  soft key on the right of the screen.

### Sequence of Operations

Refer to the table or list of UUT Oscilloscope calibration points in the *UUT Oscilloscope Manufacturer's Calibration Guide*.

Follow the sequence of calibration stages as directed by the guide, and carry out the following operations (1) to (6) at each stage.

#### 1. 9500B

Use the front panel controls to set the 9500B to output the required Luminance level, Composite Video and line standard for the UUT 'Scope cal point:

#### 2. UUT 'Scope

- Select the correct channel for the cal point.
- Select the correct range for the cal point.
- Select the correct presentation setup for the cal point.

#### 3. 9500B Set Output ON.

#### 4. UUT 'Scope

Verify stable display from TV trigger in accordance with the *UUT Oscilloscope Manufacturer's Calibration Guide*.

#### 6. 9500B Set Output OFF.

## 4.12 Linear Ramp Function

### 4.12.1 Introduction

This sub-section is a guide to the use of the 9500B for generating Linear Ramps for error code detection and trigger level marker calibrations.

For those users who require more detailed instructions for interconnections, and manipulating the front panel controls, refer to *sub-sections 4.2, 4.3 and 4.4*. Section 4.12 is divided into the following sub-sections:

4.12.1	Introduction .....	4.12-1
4.12.2	Default Settings .....	4.12-1
4.12.3	Menu Selections .....	4.12-1
4.12.3.1	Retained Channel Memory .....	4.12-1
4.12.3.2	Scope Mode Only .....	4.12-1
4.12.3.3	Right Side Screen Keys .....	4.12-1
4.12.3.4	Bottom Screen Keys .....	4.12-1
4.12.4	Linear Ramp Operation .....	4.12-1
4.12.4.1	Value Editing .....	4.12-1
4.12.5	Using the 9500B Linear Ramp Function for Error Code Detection and Trigger Level Marker Checks .....	4.12-2
4.12.5.1	Introduction .....	4.12-2
4.12.5.2	Interconnections .....	4.12-2
4.12.5.3	9500B and UUT Oscilloscope Setup .....	4.12-2
4.12.5.4	Error Code Detection — Sequence of Operations .....	4.12-2
4.12.5.5	Trigger Level — Sequence of Operations .....	4.12-2

### 4.12.2 Default Settings

When Manual mode is selected the system defaults into DC/Square function and shows the DC/Square function initial menu screen. The Linear Ramp function is accessed by first pressing the 'Aux' key on the right of the 'OSCILLOSCOPE CALIBRATOR' panel, then pressing the  soft key on the right of the screen.

Whenever the Linear Ramp menu screen is opened, except on recovery from a standby period, it will appear with the following default settings:

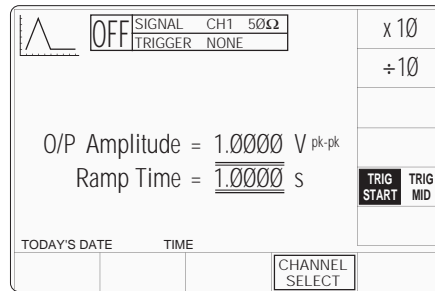

The 9500B has auto-selected a Ramp Time of 1.0000s. Trigger is auto-selected: 'TRIG START', not 'TRIG MID'. O/P Amplitude is fixed at 1.0000V.

### 4.12.3 Menu Selections

Signal Channel selection, Trigger Channel selection, Cable selection and Trigger Ratio all operate in the same way as in DC/Square function. Refer to *paras 4.5.3*.

**Note:** Without Option 5, only one signal channel and one trigger channel is available.

#### 4.12.3.1 Retained Channel Memory

Refer to *para 4.5.3.6*.

#### 4.12.3.2 Scope Mode Only

The function operates only in Scope mode. Ramp Time is the only signal variable, operating on a step sequence as selected in 'Pref'. Refer to *Section 3, sub-section 3.3*.

### 4.12.3.3 Right Side Screen Keys

**x 10** Increases Ramp Time by a factor of 10 within max. and min. limits.

**÷ 10** Decreases Ramp Time by a factor of 10 within max. and min. limits.

**TRIG START** UUT Scope trigger currently at start code. Press to provide trigger at center code.

**TRIG MID** UUT Scope trigger currently at center code. Press to provide trigger at start code.

### 4.12.3.4 Bottom Screen Keys

**CHANNEL SELECT** Permits the screen signal setup to be routed to any of the five heads, allowing selection of trigger channel, trigger ratio, cable channel and expected load (*paras 4.5.3*).

### 4.12.4 Linear Ramp Operation

#### 4.12.4.1 Value Editing

##### Amplitude

Amplitude is fixed at 1.0000V pk-pk and cannot be edited.

##### Bias

The waveform is symmetrical about ground.

##### Ramp Time

From the default 1s, the ramp time can be changed in decades from 1ms to 1s.

##### Waveform Period

The ramp times are part of waveforms with the following periods:

Ramp Time	Waveform Period
1s	3s
100ms	300ms
10ms	30ms
1ms	3ms

*Final Width = 215mm*

*Final Width = 215mm*

## 4.12.5 Using the 9500B Linear Ramp Function for Error Code Detection and Trigger Level Marker Checks

### 4.12.5.1 Introduction

The type of procedure, for generating Linear Ramps for error code detection and trigger level marker calibrations, uses the 9500B as a fixed source.

### 4.12.7.2 Interconnections

- a. Use an active head to connect from the required 9500B signal output channel to the UUT signal input channel.
- b. If a trigger is required, use an active head (or trigger cable) to connect from the required 9500B channel output to the UUT Trigger input.

### 4.12.5.3 9500B and UUT Oscilloscope Setup

The following procedures assume that the 9500B instrument is in Manual Mode. It is also assumed that the user will be familiar with the methods of editing screen values. In the case of difficulty, re-read the *paragraphs earlier in this Section 4*.

#### 1. Preparation

Ensure that both instruments are powered ON and warmed up.

#### 2. UUT 'Scope

Select the required function for pulse response calibration.

#### 3. 9500B

Ensure that the 9500B is in Linear Ramp function with Output OFF. If in any other function, press the 'Aux' key on the right of the 'OSCILLOSCOPE CALIBRATOR' panel, then the  soft key on the right of the screen.

### 4.12.5.4 Error Code Detection — Sequence of Operations

Refer to the table or list of UUT Oscilloscope test points in the *UUT Oscilloscope Manufacturer's Test Guide*.

Follow the sequence of test stages as directed by the guide, and carry out the following operations (1) to (6) at each stage.

#### 1. 9500B

Select the required channel and use the front panel controls to set the 9500B Output to the required trigger point, ramp time and expected load for the UUT 'Scope test point:

#### 2. UUT 'Scope

- a. Select the correct channel for the test point.
- b. Select the correct range for the test point.

#### 3. 9500B Set Output ON.

#### 4. UUT 'Scope

- a. Adjust the sweep speed and trigger level for a stable display.

#### 5. Error Code Check

- b. Observe and record the UUT response to the codes at the test point, as detailed in the *UUT Oscilloscope Manufacturer's Test/Calibration Guide*.

#### 6. 9500B Set Output OFF.

### 4.12.5.5 Trigger Level — Sequence of Operations

Refer to the table or list of UUT Oscilloscope test/calibration points in the *UUT Oscilloscope Manufacturer's Test Guide*.

Follow the sequence of test stages as directed by the guide, and carry out the following operations (1) to (6) at each stage.

#### 1. 9500B

Select the required channel and use the front panel controls to set the 9500B Output to the required trigger point, ramp time and expected load for the UUT 'Scope test point:

#### 2. UUT 'Scope

- a. Select the correct channel for the test point.
- b. Select the correct range for the test point.

#### 3. 9500B Set Output ON.

#### 4. UUT 'Scope

- a. Adjust the sweep speed and trigger level for a stable display.

#### 5. Trigger Level Marker Check

- a. If a trigger level calibration is provided, adjust the UUT's trigger response to the ramp to be appropriate to the settings on the 9500B screen, as detailed in the *UUT Oscilloscope Manufacturer's Test Guide*.
- b. If no adjustment is provided on the UUT 'Scope, record its trigger response at the test point as detailed in the *UUT Oscilloscope Manufacturer's Test Guide*.

#### 6. 9500B Set Output OFF.

## 4.13 Overload Pulse Function

### 4.13.1 Introduction

This sub-section is a guide to the use of the 9500B for generating Overload Pulses for use in testing oscilloscope 50Ω terminator Protection.

For those users who require more detailed instructions for interconnections, and manipulating the front panel controls, refer to *sub-sections 4.2, 4.3 and 4.4*. Section 4.13 is divided into the following sub-sections:

4.13.1	Introduction .....	4.13-1
4.13.2	Overload Protection Test .....	4.13-1
4.13.3	Default Settings .....	4.13-1
4.13.4	Menu Selections .....	4.13-1
4.13.4.1	Retained Channel Memory .....	4.13-1
4.13.5	Overload Pulse Operation .....	4.13-1
4.13.5.1	Right Side Screen Keys - Digit Edit .....	4.13-1
4.13.5.2	Right Side Screen Keys - Direct Edit .....	4.13-1
4.13.5.3	Bottom Screen Keys - Digit and Direct Edit .....	4.13-1
4.13.5.4	Value Editing .....	4.13-2
4.13.5.5	Overload Pulse Editing .....	4.13-2
4.13.6	Using the 9500B to Test the Overload Response of a UUT Oscilloscope .....	4.13-2
4.13.6.1	Introduction .....	4.13-2
4.13.6.2	Interconnections .....	4.13-2
4.13.6.3	9500B and UUT Scope Setup .....	4.13-2
4.13.6.4	Sequence of Operations .....	4.13-2

### 4.13.2 Overload Protection Test

Some oscilloscope manufacturers protect the internal 50Ω terminator with a voltage or thermal detector.

Verification of the protection function requires limited-duration application of overload, during which the protection should react and open-circuit the 50Ω terminator.

With the 9500B 'Auxiliary' Overload Pulse function selected, the Overload Pulse can be set to the UUT oscilloscope's overload test requirements, using 9500B front panel controls.

The pulse is triggered as a single event, and cannot be repeated at intervals less than 3 seconds. Sync or 100Hz triggers are provided if required.

### 4.13.3 Default Settings

When Manual mode is selected the system defaults into DC/Square function and shows the DC/Square function initial menu screen. The Overload Pulse function is accessed by first pressing the 'Aux' key on the right of the 'OSCILLOSCOPE CALIBRATOR' panel, then pressing the  soft key on the right of the screen.

**Caution:** The  symbol indicates that care must be taken when applying the overload pulse to UUT oscilloscope inputs.

Whenever the Overload Pulse menu screen is opened, except on recovery from a standby period, it will appear with the following default settings:

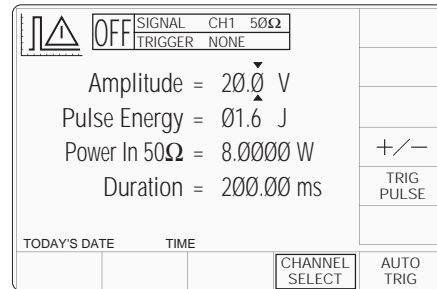

The above default screen has auto-selected the positive pulse waveform, as indicated by the icon in the top left corner. Amplitude is variable between 5 Volts and 20 Volts (default). Pulse Energy is variable between 1.6 Joules (default) and 50 Joules. Power into 50Ω and Pulse Duration are calculated from the voltage and energy settings.

### 4.13.4 Menu Selections

Signal Channel selection, Trigger Channel selection, Cable selection and Trigger Ratio all operate in the same way as in DC/Square function. Refer to *paras 4.5.3*.

**Note:** Without Option 5, only one signal channel and one trigger channel is available.

#### 4.13.4.1 Retained Channel Memory

Refer to *para 4.5.3.6*.

### 4.13.5 Overload Pulse Operation

#### 4.13.5.1 Right Side Screen Keys — Digit Edit

Keys operate on the value marked by the cursor. The key labels do not change, regardless of the cursor position.:

+/- Toggles the value between positive and negative pulses.

TRIG PULSE Press to trigger a single shot of the specified pulse output.

No further pulse can be triggered within three seconds, otherwise a screen message will appear.

#### 4.13.5.2 Right Side Screen Keys — Direct Edit

Right side screen keys operate on the value in the edit box, and acting in place of the  key, exit from Direct Edit back to Digit Edit; then set the value as evaluated in the box:

##### a. Cursor on Amplitude:

V Evaluates the number in the box in Volts.

##### b. Cursor on Pulse Energy:

J Evaluates the number in the box in Joules.

#### 4.13.5.3 Bottom Screen Keys — Digit and Direct Edit

CHANNEL SELECT Permits the screen signal setup to be routed to any of the five heads, allowing selection of trigger channel, trigger ratio and cable channel (*paras 4.5.3*).

AUTO TRIG Produces a train of triggers at 100Hz to trigger the UUT oscilloscope continuously.

*continued overleaf →*

*Final Width = 215mm*

Final Width = 215mm

#### 4.13.5 Overload Pulse Operation (Contd.)

##### 4.13.5.4 Value Editing

###### Overload Protection

Different oscilloscope manufacturers have different ways of defining the overload which will activate their protection system.

For example, into  $50\Omega$ , the two specifications  $\pm 20V$  for 200ms and 1.6J at a power of 8W are equivalent.

Normally, where voltage and time are specified, the voltage will be set and the energy adjusted to achieve the specified time.

The 9500B can output single pulses whose two adjustable constituents are Amplitude and Pulse Energy. The limits on these parameters are:

Amplitude	$\pm 5V$ to $\pm 20V$
Pulse Energy	1.6J to 50J

For a fixed Pulse Amplitude the power into  $50\Omega$  will remain constant, regardless of pulse duration. Adjusting the Pulse Energy operates on the pulse duration at fixed amplitude. Controlling these two parameters can adapt to all specifications between the above limits.

Maximum and minimum power values into  $50\Omega$  are:

Power	0.5W to 8W
Amplitude	$\pm 5V$ to $\pm 20V$

Maximum and minimum pulse durations, with corresponding parameters, are:

Duration	200ms to 100s
Amplitude	$\pm 20V$ to 5V
Pulse Energy	1.6J to 50J
Power	8W to 0.5W

##### 4.13.5.5 Overload Pulse Editing

The 'Digit' and 'Direct' editing processes follow the same general rules as for editing DC/Square described in *paras 4.4*.

#### 4.13.6 Using the 9500B to Test the Overload Response of a UUT Oscilloscope

##### 4.13.6.1 Introduction

The test procedure consists of inputting a single pulse as specified in the oscilloscope manufacturer's overload protection test, and checking that the protection reacts to open-circuit the  $50\Omega$  input termination.

The form of input overload indication will vary between oscilloscopes.

##### 4.13.6.2 Interconnections

- a. Use an active head to connect from the required 9500B signal output channel to the UUT input channel.
- b. If a UUT trigger is required, use an active head (or trigger cable) to connect from the required 9500B channel output to the UUT Trigger input.

##### 4.13.6.3 9500B and UUT Scope Setup

The following procedures assume that the 9500B instrument is in Manual Mode. It is also assumed that the user will be familiar with the methods of editing screen values. In the case of difficulty, re-read the *paragraphs earlier in this Section 4*.

###### 1. Preparation

Ensure that both instruments are powered ON and warmed up.

###### 2. UUT 'Scope

Select the required function for overload pulse protection test.

###### 3. 9500B

Ensure that the 9500B is in Overload Pulse Function with Output OFF. If in any other function, press the 'Aux' key on the right of the 'OSCILLOSCOPE CALIBRATOR' panel, then the  soft key on the right of the screen.

##### 4.13.6.4 Sequence of Operations

Refer to the table or list of UUT Oscilloscope Overload Test points in the *UUT Oscilloscope Manufacturer's Test Guide*.

Follow the sequence of test stages as directed by the guide, and carry out the following operations (1) to (5) at each stage.

###### 1. 9500B

- a. Use the front panel controls to set the 9500B Output to the required Overload Pulse and polarity for the UUT 'Scope test point.
- b. If the scope requires a repetitive trigger, press the 'AUTO TRIG' soft key at the bottom right corner of the screen.

###### 2. UUT 'Scope

- a. Select the correct channel for the test point.
- b. Select the correct range for the test point.
- c. If required, adjust the sweep speed and trigger level for a stable display.

###### 3. 9500B

- a. Set Output ON.
- b. Press the 'TRIG PULSE' screen key once; observe and note the UUT scope response.
- c. If required, repeat pressing the 'TRIG PULSE' screen key as detailed in the *UUT Oscilloscope Manufacturer's Test Guide*; observe and note the UUT scope responses.

###### 4. UUT Response

Record the UUT 'Scope response at the test point as detailed in the *UUT Oscilloscope Manufacturer's Test Guide*. If required, reset the scope protection circuit.

5. 9500B Set Output OFF.

## 4.14 Zero Skew Function

### 4.14.1 Introduction

'Skew' is defined as the relative delay between two or more selected channels. If the channel delays are equalized, then the condition is known as 'Zero Skew'. This sub-section is a guide to using the 9500B Zero Skew function to:

- Adjust selected 9500B channels to equalize their delays.
- Use the same channels as sources for measuring the skew between input channels of a UUT oscilloscope.
- Also, two cable channels can be precision-aligned.

For those users who require more detailed instructions for interconnections, and manipulating the front panel controls, refer to sub-sections 4.2, 4.3 and 4.4.

Section 4.14 is divided into the following sub-sections:

4.14.1	Introduction .....	4.14-1
4.14.2	Default Settings .....	4.14-1
4.14.3	Menu Selections .....	4.14-1
4.14.3.1	Signal Channel Selection .....	4.14-1
4.14.3.2	Right Side Screen Keys — Digit Edit/Sequence Scroll .....	4.14-2
4.14.3.3	Right Side Screen Keys — Numeric Entry .....	4.14-2
4.14.3.4	Bottom Screen Keys .....	4.14-2
4.14.4	Zero Skew Operation .....	4.14-2
4.14.4.1	Precision Alignment of 9500B Channel Outputs .....	4.14-2
4.14.4.2	Preservation of Alignment .....	4.14-2
4.14.5	Measurement of UUT Oscilloscope Channel Skew .....	4.14-3
4.14.5.1	Introduction .....	4.14-3
4.14.5.2	Interconnections .....	4.14-3
4.14.5.3	9500B and UUT Scope Setup .....	4.14-3
4.14.5.4	Sequence of Operations .....	4.14-3

### 4.14.2 Default Settings

When Manual mode is selected the system defaults into DC/Square function and shows the DC/Square function initial menu screen. The Zero Skew function is accessed by first pressing the 'Aux' key on the right of the 'OSCILLOSCOPE CALIBRATOR' panel, then pressing the  soft key on the right of the screen.

Whenever the Zero Skew menu screen is opened, except on recovery from a standby period, it will appear with the following default settings:

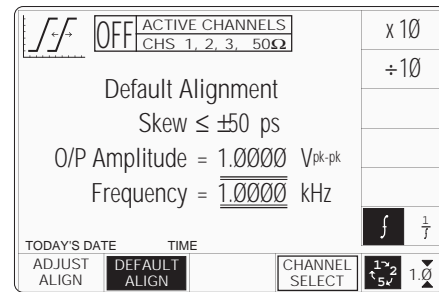

The above default screen has auto-selected 'Default Alignment', as indicated by the top line of text and the highlighted screen key on the bottom row. The unequallized (default) alignment has a maximum skew of  $\pm 50$ ps between channels. The amplitude and default frequency are also shown on the screen.

The selected output channels are listed in the central box at the top of the screen.

### 4.14.3 Menu Selections

#### 4.14.3.1 Signal Channel Selection

Signal Channel selection differs from other functions in that all channels fitted with an active head will be selected on entering the function. In the unit used for this description, channels 1, 2 and 3 had heads attached, nothing was fitted to channel 4, and a trigger cable was fitted to channel 5.

The required channels can be selected on a second menu screen. This is activated by pressing the 'CHANNEL SELECT' screen key on the bottom row. The screen changes to show the available channels, which are already selected:

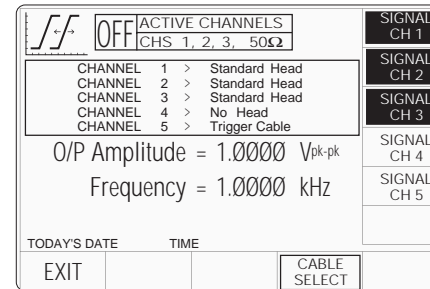

Neither channel 4 nor 5 has an active head fitted. The highlights on channels 1, 2 and 3 indicate that only these channels have heads active (confirmed by the legend in the top central box), and for these zero skew can be used. Toggling any one of these soft keys deselects and reselects that channel. Note that the function cannot operate with only one channel selected, which will cause an error message to appear on the screen.

In Zero Skew function, expected load is fixed at  $50\Omega$  on all signal channels, so the  $50\Omega/1M\Omega$  switching soft key is absent.

In this function, the 'trigger channel' soft key is absent.

When the Channel Select screen is presented, adjustment of Frequency/Period is inhibited.

Pressing the 'EXIT' key will revert back to the standard Zero Skew screen of para 4.14.2, the top central box showing the channels which have been selected.

*Final Width = 215mm*



*continued overleaf →*

Final Width = 215mm

#### 4.14.3 Menu Selections (Contd.)

##### 4.14.3.2 Right Side Screen Keys — Digit Edit/Sequence Scroll

Keys operate only on the value of Frequency/Period:

- X10 Multiplies the marked value by ten.
- +10 Divides the marked value by ten.
-  Press to change display from Frequency to Period.
-  Press to change display from Period to Frequency.

##### 4.14.3.3 Right Side Screen Keys — Numeric Entry

Right side screen keys operate on the value in the edit box, and acting in place of the ↵ key, exit from Numeric Entry back to Digit Edit/Sequence Scroll; then set the value as evaluated in the box:

Keys operate only on the value of Frequency/Period:

- X10 Multiplies the marked value by ten.
- +10 Divides the marked value by ten.
- Hz Evaluates the number in the box in **Hertz**.
- kHz Evaluates the number in the box in **Kilohertz**.
- MHz Evaluates the number in the box in **Megahertz**.
- GHz Evaluates the number in the box in **Gigahertz**.

##### 4.14.3.4 Bottom Screen Keys

- ADJUST ALIGN Press to select Precision Alignment to adjust the alignment on each active channel, and store the result.
- DEFAULT ALIGN After Precision Alignment has been stored, toggles between Default and Precision Alignment.
- CHANNEL SELECT Permits Zero Skew to be selected for any two or more of the five channels, providing that active heads are fitted to those channels (*para 4.14.3.1*).

 Press to select Direct Mode (*paras 4.4.3/4*).

 Press to select Scope Mode (sets the step sequence to '1, 2, 5' or '1, 2, 2.5, 4, 5' as chosen using the **Preferences** key) (*paras 4.4.1/2*).

#### 4.14.4 Zero Skew Operation

##### 4.14.4.1 Precision Alignment of 9500B Channel Outputs

The 9500B is set into Zero Skew function. Two or more channel heads are aligned, in turn, on the same input channel of an oscilloscope (can be the UUT oscilloscope), while triggering from another channel or external trigger.

##### Precision Alignment

Using Zero Skew function, 'CHANNEL SELECT' is used to select the channels for

adjustment.

With output off, a channel active head is connected into the scope input channel to be used. At the required frequency, with output on, the channel delay at half-amplitude is marked using a cursor (also, by pressing the 'ADJUST ALIGN' soft key, the channel delay can be adjusted, for a particular screen alignment).

With output off, the first active head is removed and a second channel's head is connected into the same scope input channel. With output on, 'ADJUST ALIGN' allows the second channel delay to be adjusted to the same cursor mark. Repeating the adjustment for all other channels achieves accurate common alignment.

Having aligned the selected output channels, they can be used to apply signals simultaneously to measure the relative delays between the input channels of a UUT oscilloscope.

##### 4.14.4.2 Preservation of Alignment

The 9500B Zero Skew function will allow only the aligned channels to be used together with their aligned heads. Unless channels have been reconfigured, merely selecting another function will not destroy the alignment when Zero Skew function is again entered. Deselecting a channel allows the other aligned channels to be used. Reselecting the deselected channel restores the alignment if the same head is fitted.

If one of the heads is removed from its output channel, and another substituted, the 9500B will recognize the new head as being unaligned, and will not allow it to be used until another precision alignment has been carried out.



---

## 4.14.5 Measurement of UUT Oscilloscope Channel Skew

### 4.14.5.1 Introduction

The procedure depends on pre-alignment of the requisite number of active heads (if better than  $\pm 50$ ps calibrator alignment is required — when UUT specification is  $< 200$ ps or better), as broadly described in *para 4.14.4.1*.

### 4.14.5.2 Interconnections

Connect the required active heads to the UUT oscilloscope input channels.

### 4.14.5.3 9500B and UUT 'Scope Setup

The following procedure assumes that the 9500B instrument is in Manual Mode. It is also assumed that the user will be familiar with front panel operation. In case of difficulty, re-read the *paragraphs earlier in this Section 4*.

#### 1. Preparation

Ensure that both instruments are powered ON and warmed up.

#### 2. UUT 'Scope

Select the required function for input channel skew test.

#### 3. 9500B

Ensure that the 9500B is in Zero Skew function with Output OFF. If in any other function, press the 'Aux' key on the right of the 'OSCILLOSCOPE CALIBRATOR' panel, then the  soft key on the right of the screen.

Ensure that the required channels are selected and, if necessary, have been 'Precision Aligned'.

### 4.14.5.4 Sequence of Operations

Refer to the table or list of UUT Oscilloscope Input delay measurement points in the *UUT Oscilloscope Manufacturer's Test Guide*.

Follow the sequence of test stages as directed by the guide, and carry out the following operations (1) to (5) at each stage.

#### 1. UUT 'Scope

- a. Select the correct signal test channels.
- b. Select trigger for the test from the correct channel.
- c. Select the correct Y sensitivity range.
- d. Select the correct timebase speed for the test.
- e. If required, adjust the sweep speed and trigger level for a stable display.

#### 2. 9500B

Set Output ON.

#### 3. UUT 'Scope

- a. Adjust each channel Y position control to superimpose the waveforms, equally disposed across the X axis.
- b. Use the UUT oscilloscope controls to measure the relative delays on each channel (at half amplitude).

#### 4. UUT Response

Record the UUT input channels' relative delays as detailed in the *UUT Oscilloscope Manufacturer's Test Guide*.

5. 9500B Set Output OFF.

*Final Width = 215mm*

BLANK PAGE (LEFT-HAND)

## 4.15 Auxiliary Input

### 4.15.1 Introduction

This sub section is a guide to the use of the 9500B to generate variable width pulses for the testing trigger timing circuitry within an Oscilloscope

For those users who require more detailed instructions for interconnections, and manipulating the front panel controls, refer to sub-sections 4.2, 4.3 and 4.4.

Section 4.15 is divided into the following sub-sections:

4.15.1	Introduction .....	4.15-1
4.15.2	Automated Routing .....	4.15-1
4.15.3	Default Settings .....	4.15-1
4.15.4	Menu Selections .....	4.15-1
4.15.4.1	Retained Channel Memory .....	4.15-1
4.15.5	Auxiliary Input Operation .....	4.15-1
4.15.5.1	Bottom Screen Keys .....	4.15-1
4.15.6	Using the 9500B for Automated Routing of User-Specific Calibration Signals to UUT Oscilloscope Input Channels .....	4.15-2
4.15.6.1	Introduction .....	4.15-2
4.15.6.2	Interconnections .....	4.15-2
4.15.6.3	User's Signal Source, 9500B and UUT Scope Setup .....	4.15-2
4.15.6.4	Sequence of Operations .....	4.15-2

### 4.15.2 Automated Routing

Despite the huge flexibility if the 9500B, it is sometimes required to apply signals from user's equipment to the inputs of a UUT oscilloscope, for specific calibration or test purposes.

With the 9500B Auxiliary Input selected, wideband passive routing is available from a rear-panel 50Ω SMA input through to the selected 9500B channel output, using 9500B front panel controls.

No trigger pickoff is provided, and internal triggers are not available.

### 4.15.3 Default Settings

When Manual mode is selected the system defaults into DC/Square function and shows the DC/Square function initial menu screen. The Auxiliary Input function is accessed by first pressing the 'Aux' key on the right of the 'OSCILLOSCOPE CALIBRATOR' panel, then pressing the **AUX IN** soft key on the right of the screen.

Whenever the Auxiliary Input screen is opened, except on recovery from a standby period, it will appear as follows (for details of non-volatility, refer also to para 4.5.3.6):

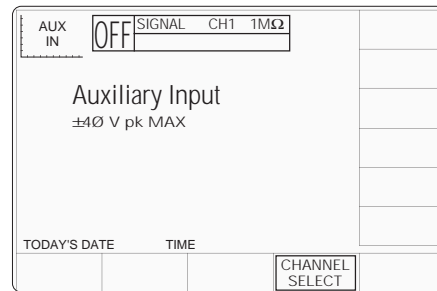

### 4.15.4 Menu Selections

Signal Channel selection, Trigger Channel selection, Cable selection and Trigger Ratio all operate in the same way as in DC/Square function. Refer to paras 4.5.3.

**Note:** Without Option 5, only one signal channel and one trigger channel is available.

#### 4.15.4.1 Retained Channel Memory

Refer to para 4.5.3.6.

### 4.15.5 Auxiliary Input Operation

#### 4.15.5.1 Bottom Screen Keys

**CHANNEL SELECT** Permits the AUX INPUT signal to be routed to any of the five heads, allowing selection of signal channel and expected load only (paras 4.5.3).

*Final Width = 215mm*

continued overleaf →

*Final Width = 215mm*

---

## 4.15.6 Using the 9500B for Automated Routing of User-Specific Calibration Signals to UUT Oscilloscope Input Channels

### 4.15.6.1 Introduction

The calibration procedure consists of routing a signal from a user's source to a specified channel input, as required by the oscilloscope manufacturer's calibration procedure.

### 4.15.6.2 Interconnections

- a. Use the appropriate active head to connect from the required 9500B signal output channel to the UUT input channel.
- b. Connect the user's source to the 'AUXILIARY INPUT' SMA connector on the 9500B rear panel.

### 4.15.6.3 User's Signal Source, 9500B and UUT Scope Setup

The following procedures assume that the 9500B instrument is in Manual Mode. It is also assumed that the user will be familiar with front panel operation. In case of difficulty, re-read the *paragraphs earlier in this Section 4*.

#### 1. Preparation

Ensure that all instruments are powered ON and warmed up.

#### 2. UUT 'Scope

Select the required function requiring the user's specific signal .

#### 3. 9500B

Ensure that the 9500B is in Auxiliary Input with Output OFF. If in any other function, press the 'Aux' key on the right of the 'OSCILLOSCOPE CALIBRATOR' panel, then the **AUX IN** soft key on the right of the screen.

#### 4. User's Signal Source

Set up the signal source to provide the required signal to the 9500B rear panel 'Auxiliary Input' (refer to the Auxiliary Input Routing

Specification in *para 4.15.5.2*).

### 4.15.6.4 Sequence of Operations

Refer to the table or list of UUT Oscilloscope calibration points in the *UUT Oscilloscope Manufacturer's Calibration Guide*.

Follow the sequence of calibration stages as directed by the guide, and carry out the following operations (1) to (5) at each stage.

#### 1. User's Signal Source

Ensure that the correct signal is being output.

#### 2. UUT 'Scope

- a. Select the correct channel for the cal point.
- b. Select the correct range for the cal point.

#### 3. 9500B Set Output ON.

#### 4. UUT 'Scope

- a. Adjust the sweep speed and trigger level for a stable display.
- b. Observe and record the UUT's response to the user-specific signal as detailed in the *UUT Oscilloscope Manufacturer's Calibration Guide*.

#### 5. 9500B Set Output OFF.

## 4.16 Load Resistance and Capacitance Measurement

### 4.16.1 Introduction

This sub-section is a guide to using the 9500B to measure the resistive or capacitive load presented by the channel inputs of a UUT oscilloscope.

For those users who require more detailed instructions for interconnections, and manipulating the front panel controls, refer to *sub-sections 4.2, 4.3 and 4.4.*

Section 4.16 is divided into the following sub-sections:

4.16.1	Introduction .....	4.16-1
4.16.2	Measurement Method .....	4.16-1
4.16.3	Default Settings .....	4.16-1
4.16.3.1	Load Resistance Defaults .....	4.16-1
4.16.3.2	Load Capacitance Defaults .....	4.16-1
4.16.4	Menu Selections .....	4.16-1
4.16.4.1	Load Resistance Menus .....	4.16-1
4.16.4.2	Load Capacitance Menus .....	4.16-1
4.16.4.3	Retained Channel Memory .....	4.16-1
4.16.5	Measurement Operation .....	4.16-1
4.16.5.1	Bottom Screen Keys (Resistance) .....	4.16-1
4.16.5.2	Bottom Screen Keys (Capacitance) .....	4.16-1
4.16.6	Use the 9500B to Measure the	
	Load Resistance or Load Capacitance .....	4.16-2
4.16.6.1	Introduction .....	4.16-2
4.16.6.2	Interconnections .....	4.16-2
4.16.6.3	9500B and UUT Scope Setup .....	4.16-2
4.16.6.4	Sequence of Operations	
	(Load Resistance) .....	4.16-2
4.16.6.5	Sequence of Operations	
	(Load Capacitance) .....	4.16-2

### 4.16.2 Measurement Method

UUT Oscilloscope input load resistance or capacitance can be measured directly via any active head.

With the 9500B 'Auxiliary' functions, and ' $\Omega$ ' or ' $\text{pF}$ ' function selected, the load resistance or capacitance presented by the UUT oscilloscope input to the active head will be shown on the screen. No triggers are provided.

### 4.16.3 Default Settings

#### 4.16.3.1 Load Resistance Defaults

The Load Resistance Measurement is accessed by first pressing the 'Aux' key on the right of the 'OSCILLOSCOPE CALIBRATOR' panel, then pressing the  $\Omega$  soft key at the bottom of the screen.

Whenever the Load Resistance screen is opened, except on recovery from a standby period, it will appear as follows (*but also refer to para 4.5.3.6*):

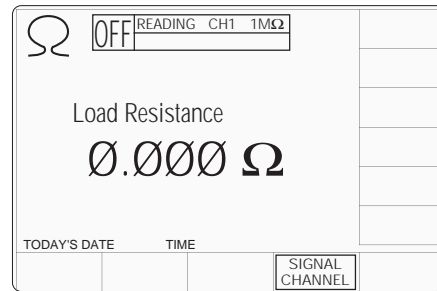

#### 4.16.3.2 Load Capacitance Defaults

The Load Capacitance Measurement is accessed by first pressing the 'Aux' key on the right of the 'OSCILLOSCOPE CALIBRATOR' panel, then pressing the  $\text{pF}$  soft key at the bottom of the screen.

Whenever the Load Capacitance screen is opened, except on recovery from a standby period, it will appear as follows (*but also refer to para 4.5.3.6*):

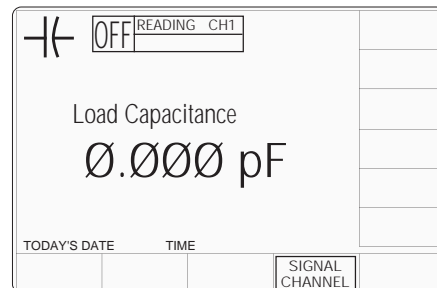

### 4.16.4 Menu Selections

#### 4.16.4.1 Load Resistance Menus

Only Signal Channel and Expected Load selections operate in the same way as in DC/Square function. Refer to *paras 4.5.3.*

Note: Measurement is available only when OUTPUT is ON.

#### 4.16.4.2 Load Capacitance Menus

Only Signal Channel selection operates in the same way as in DC/Square function. Refer to *paras 4.5.3.*

Note: Measurement is available only when OUTPUT is ON.

#### 4.16.4.3 Retained Channel Memory

Refer to *para 4.5.3.6.*

### 4.16.5 Measurement Operation

#### 4.16.5.1 Bottom Screen Keys (Resistance)

SIGNAL CHANNEL Permits the measurement setup to be routed via any of the five heads, also allowing selection of expected load (*paras 4.5.3*).

#### 4.16.5.2 Bottom Screen Keys (Capacitance)

SIGNAL CHANNEL Permits the measurement setup to be routed via any of the five heads (*paras 4.5.3*).

*Final Width = 215mm*

*Final Width = 215mm*

## 4.16.6 Use the 9500B to Measure Load Resistance or Load Capacitance

### 4.16.6.1 Introduction

Both measurement procedures consists of connecting an active head to each channel input in turn, and checking that the resulting resistance or capacitance reading is within specification limits.

### 4.16.6.2 Interconnections

Use the appropriate active head to connect from the required 9500B signal output channel to the UUT input channel. No triggers are required or available.

### 4.16.6.3 9500B and UUT Scope Setup

#### 1. Preparation

Ensure that both instruments are powered ON and warmed up.

#### 2. UUT 'Scope

Select the required function for Load Resistance or Load Capacitance measurement as required.

#### 3. 9500B

Ensure that the 9500B is in Load Resistance or Load Capacitance Measurement function with Output OFF. If in any other function, press the 'Aux' key on the right of the 'OSCILLOSCOPE CALIBRATOR' panel, then the  $\Omega$  or  $\text{—}(\leftarrow$  soft key at the bottom of the screen.

### 4.16.6.4 Sequence of Operations (Load Resistance)

Refer to the table or list of UUT Oscilloscope Load Resistance measurement points in the *UUT Oscilloscope Manufacturer's Test/Calibration Guide*.

Follow the sequence of test stages as directed by the guide, and carry out the following operations (1) to (5) at each stage.

#### 1. 9500B

- a. Press the 'SIGNAL CHANNEL' screen key on the bottom row.
- b. Select the required signal channel.
- c. Select the appropriate load (50 $\Omega$  or 1M $\Omega$ ) using the toggle screen key in the bottom right corner.
- d. Press 'EXIT'.

#### 2. UUT 'Scope

- a. Select the correct channel for the test point.
- b. Select DC Coupling if required.

#### 3. 9500B

- a. Set Output ON.
- b. Read the Load Resistance value from the screen.

#### 4. UUT Response

Record the UUT channel load resistance at the test point as detailed in the *UUT Oscilloscope Manufacturer's Test/Calibration Guide*.

5. 9500B Set Output OFF.

### 4.16.6.5 Sequence of Operations (Load Capacitance)

Refer to the table or list of UUT Oscilloscope Load Capacitance measurement points in the *UUT Oscilloscope Manufacturer's Test/Calibration Guide*.

Follow the sequence of test stages as directed by the guide, and carry out the following operations (1) to (4) at each stage.

#### 1. 9500B

- a. Press the 'SIGNAL CHANNEL' screen key on the bottom row.
- b. Select the required signal channel.
- c. Press 'EXIT'.

#### 2. UUT 'Scope

- a. Select the correct channel for the test point.
- b. Select DC Coupling if required.

#### 3. 9500B

- a. Set Output ON.
- b. Read the Load Capacitance value from the screen.

#### 4. UUT Response

Record the UUT channel Load Capacitance at the test point as detailed in the *UUT Oscilloscope Manufacturer's Test/Calibration Guide*.

5. 9500B Set Output OFF.

## 4.17 Input Leakage Function

### 4.17.1 Introduction

This sub-section is a guide to using the 9500B to short-circuit and open-circuit channel inputs of a UUT oscilloscope to test for input leakage. For those users who require more detailed instructions for interconnections, and manipulating the front panel controls, refer to *sub-sections 4.2, 4.3 and 4.4.*

Section 4.17 is divided into the following sub-sections:

4.17.1	Introduction .....	4.17-1
4.17.2	Input Leakage Test .....	4.17-1
4.17.3	Default Settings .....	4.17-1
4.17.4	Menu Selections .....	4.17-1
4.17.4.1	Retained Channel Memory .....	4.17-1
4.17.5	Input Leakage Operation .....	4.17-1
4.17.5.1	Bottom Screen Keys .....	4.17-1
4.17.5.2	Open Circuit Output Leakage Specification .....	4.17-1
4.17.6	Using the 9500B to Test the Input Leakage Current of a UUT Oscilloscope .....	4.17-2
4.17.6.1	Introduction .....	4.17-2
4.17.6.2	Interconnections .....	4.17-2
4.17.6.3	9500B and UUT Scope Setup .....	4.17-2
4.17.6.4	Sequence of Operations .....	4.17-2

### 4.17.2 Input Leakage Test

UUT Oscilloscope input leakage current can be tested by noting the difference in deflection when a channel's input is open-circuited and when it is short-circuited.

With the 9500B 'Auxiliary' Input Leakage function selected, open and short circuits can be imposed on the selected channel input, using 9500B front panel controls.

Scope triggers at 100Hz are provided if required.

### 4.17.3 Default Settings

When Manual mode is selected the system defaults into DC/Square function and shows the DC/Square function initial menu screen. The Input Leakage function is accessed by first pressing the 'Aux' key on the right of the 'OSCILLOSCOPE CALIBRATOR' panel, then pressing the  soft key on the bottom of the screen.

Whenever the Input Leakage menu screen is opened, except on recovery from a standby period, it will appear with the following default settings:

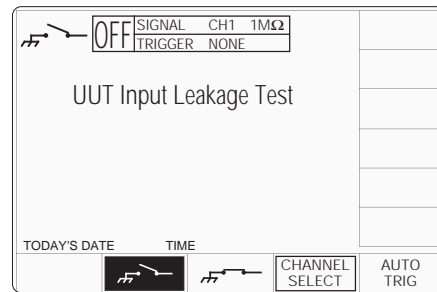

The above default screen has auto-selected the open-circuit output, as indicated by the icon in the top left corner, and the highlighted screen key on the bottom row.

### 4.17.4 Menu Selections

Signal Channel selection, Trigger Channel selection and Cable selection all operate in the same way as in DC/Square function. Refer to *paras 4.5.3.*

#### 4.17.4.1 Retained Channel Memory

Refer to *para 4.5.3.6.*

### 4.17.5 Input Leakage Operation

#### 4.17.5.1 Bottom Screen Keys

 Press to select short-circuit output, and provide a one-shot trigger to the UUT.

 Press to select open-circuit output, and provide a one-shot trigger to the UUT.

CHANNEL SELECT Permits the screen signal setup to be routed to any of the five heads, allowing selection of trigger channel and cable channel (*paras 4.5.3.*)

AUTO TRIG Produces a train of triggers at 100Hz to trigger the UUT oscilloscope.

#### 4.17.5.2 Open Circuit Output Leakage Specification

##### Output Leakage Current

The 9500B output leakage current in any channel output is less than  $\pm 50\text{pA}$ .

*Final Width = 215mm*

Final Width = 215mm

## 4.17.6 Using the 9500B to Test the Input Leakage Current of a UUT Oscilloscope

### 4.17.6.1 Introduction

The test procedure consists of applying an open-circuit and short-circuit to each channel input in turn, as specified in the oscilloscope manufacturer's input leakage test, and checking that the resulting deflection is within specification limits.

### 4.17.6.2 Interconnections

- a. Use the appropriate active head to connect from the required 9500B signal output channel to the UUT input channel.
- b. If a UUT trigger is required, use the appropriate active head (or trigger cable) to connect from the required 9500B channel output to the UUT Trigger input.

### 4.17.6.3 9500B and UUT Scope Setup

The following procedures assume that the 9500B instrument is in Manual Mode. It is also assumed that the user will be familiar with front panel operation. In case of difficulty, re-read the *paragraphs earlier in this Section 4*.

#### 1. Preparation

Ensure that both instruments are powered ON and warmed up.

#### 2. UUT 'Scope

Select the required function for Input Leakage test.

#### 3. 9500B

Ensure that the 9500B is in Input Leakage Function with Output OFF. If in any other function, press the 'Aux' key on the right of the 'OSCILLOSCOPE CALIBRATOR' panel, then the  soft key on the bottom of the screen.

### 4.17.6.4 Sequence of Operations

Refer to the table or list of UUT Oscilloscope Input Leakage Test points in the *UUT Oscilloscope Manufacturer's Test Guide*.

Follow the sequence of test stages as directed by the guide, and carry out the following operations (1) to (7) at each stage.

#### 1. 9500B

- c. If the scope requires a repetitive trigger, press the 'AUTO TRIG' soft key at the bottom right corner of the screen.

#### 2. UUT 'Scope

- a. Select the correct channel for the test point.
- b. Select the correct range for the test point.
- c. If required, adjust the sweep speed and trigger level.

#### 3. 9500B

- a. Set Output ON.
- b. Press the  screen key to select short circuit output, and provide a one-shot trigger to the UUT.

#### 4. UUT 'Scope

Adjust the 'Y' position control to place the display on the zero axis.

#### 5. 9500B

Press the  screen key to select open circuit output, and provide a one-shot trigger to the UUT.

#### 6. UUT Response

Record the UUT 'Scope 'Y' deflection at the test point as detailed in the *UUT Oscilloscope Manufacturer's Test Guide*.

7. 9500B Set Output OFF.



## 4.18 Pulse Width Function

### 4.18.1 Introduction

This sub section is a guide to the use of the 9500B to generate variable width pulses for the testing trigger timing circuitry within an Oscilloscope.

For those users who require more detailed instructions for interconnections, and manipulating the front panel controls, refer to *sub-sections 4.2, 4.3 and 4.4.*

### 4.18.2 Trigger Qualification Timer Tests

Modern digital Oscilloscopes often feature sophisticated trigger circuitry capable of distinguishing events within a time window, e.g. detection of a pulse narrower (or wider) than a user determined time. The Oscilloscope will use its internal (sampling) clock to measure the time between, in this case rising and falling edges of the trigger waveform. However, in many cases the resolution of this measurement is extended by a short duration analogue timer. It is this timer that demands independent verification, and sometimes adjustment, using a short duration pulse of known width.

With the 9500B “Auxiliary” Pulse Width function selected a narrow pulse of suitable and known width can be set up using the front panel controls and applied to the UUT input.

### 4.18.3 Default Settings

When Manual mode is selected the system defaults into the DC/Square function and shows the DC/Square function initial menu screen. The Pulse Width function is accessed by first pressing the “Aux” key on the right of the “OSCILLOSCOPE CALIBRATOR” panel, then pressing the  soft key on the lower right of the screen.

Whenever the Pulse Width menu screen is opened, except on recovery from a standby period, it will appear with the following default settings.

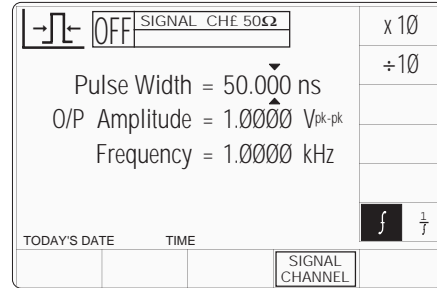

The above default screen has selected a 50ns Pulse Width at a frequency of 1MHz.. Output amplitude is fixed at 1Vpk-pk into 50Ohm.

### 4.18.4 Menu Selections

Signal Channel selection operates in the same way as in DC/Square function, Refer to *paras 4.5.3.* There is no Trigger Output or selection associated with this function.

#### 4.18.4.1 Retained Channel Memory



Refer to *Para 4.5.3.6*

#### 4.18.4.2 Direct Mode Only

This function supports Digit Edit, Numeric Entry within Direct Mode only; Scope Mode entry is not available. Refer *para 4.4.2*

### 4.18.5 Pulse Width Operation

#### 4.18.5.1 Right Side Screen Keys

-  Increases Pulse Width or Frequency by a factor of 10 within max. and min. limits
-  Decreases Pulse Width or Frequency by a factor of 10 within max. and min. limits
-  Press to toggle the display waveform Frequency or Period

#### 4.18.5.2 Bottom Screen Keys

-  Permits the screen signal set-up to be routed to any of the five heads.

*Final Width = 215mm*

---

*Final Width = 215mm*  
Left Blank

---

# Section 5 Using the Model 9500B — Procedure Mode

## 5.1 About Section 5

Section 5 is a guide to using procedure card in the 9500B, to calibrate manually-operated oscilloscopes (UUTs). For a guide to using front panel controls in Manual Mode, please turn to *Section 4*.

Because the actual procedures are contained within the cards, this section is limited to general points, and access to the programs on the cards. Section 5 is divided into the following sub-sections:

	page
5.1 About Section 5 (this sub-section).	
5.2 Procedure mode — Safety and General Notes.	
5.2.1 Introduction .....	5.2-1
5.2.2 Safety Features .....	5.2-1
5.2.3 General Notes .....	5.2-1
5.2.4 Printing Setup .....	5.2-2
5.2.5 Saving Results on Memory Cards .....	5.2-3
5.3 Procedure mode — Access Guide.	
5.3.1 Introduction .....	5.3-1
5.3.2 Mode Selection .....	5.3-1
5.3.3 Selection of Procedure Mode — Entry Menus Common to All Procedures .....	5.3-1

*Final Width = 215mm*

BLANK PAGE (LEFT-HAND)

## 5.2 Procedure Mode — Safety and General Notes

### 5.2.1 Introduction

Sub-section 5.2 introduces notes to Procedure mode. The following topics are covered:

	Page
5.2.1 Introduction .....	5.2-1
5.2.2 Safety Features .....	5.2-1
<i>High Voltage Warning</i> .....	5.2-1
<i>Emergency Action - Use of OUTPUT OFF</i> .....	5.2-1
5.2.3 General Notes .....	5.2-1
Output Slewing .....	5.2-1
5.2.4 Printing Setup .....	5.2-2
5.2.4.1 Printer Type .....	5.2-2
5.2.4.2 Certificate Formatting and Data Presentation .....	5.2-2
5.2.4.3 Enable Printing .....	5.2-2
5.2.5 Saving Results on Memory Cards .....	5.2-3
5.2.5.1 Results Card Enabling and Insertion .....	5.2-3
5.2.5.2 Stage-by-Stage Results Saving .....	5.2-3
5.2.5.3 Results Memory Space .....	5.2-3
5.2.5.4 Static RAM Card - Non-Rechargeable Battery Condition .....	5.2-3
5.2.5.5 Static RAM Card - Re-chargeable Battery .....	5.2-3

### 5.2.2 Safety Features

The Model 9500B incorporates safety mechanisms in all its internal programming. For example: a user must make an extra confirming key-press in order to raise a voltage at the terminals above a pre-determined value.

#### ***High Voltage Warning — Take Care***



After pressing **OK** or **REPEAT PREV.** keys: *If the procedure writer has not conformed strictly to the procedure-writing guidelines, **HIGH VOLTAGES MAY APPEAR WITHOUT WARNING AT ANY POINT IN THE PROCEDURE. ANY WARNING BEEPS SHOULD BE TAKEN VERY SERIOUSLY!***

#### ***Emergency Action — Use of OUTPUT OFF Button***



*In emergency, the most effective way of turning output off (other than pulling the line-power plug) is to press the **OUTPUT OFF** button on the right of the front panel. This may sound obvious, but a special feature of the **OFF** button operation is that as well as sending the appropriate message to the operating system, it also has a hardware link which bypasses the software. Even if the program has locked up, this button is effective in cutting off the output.*

### 5.2.3 General Notes

#### 5.2.3.1 Output Slewing

In the '1 Year Verification' procedure within Procedure mode, there is a need for the 9500B output to be adjusted ('slewed') around the nominal test point value. This enables the 'slew error' to be registered in the 9500B internal memory, to appear on printed certificates.

#### **Front Panel Controls — Fine Slewing Adjustments**

To provide slewing in single-digit increments, there is an 'ENABLE CURSOR' screen key on the bottom row of all 'READ — SLEW SOURCE' screens. The effect of pressing this key is to place the cursors on the least-significant digit of the 'Applied Value', enabling all the cursor keys, shift keys and spinwheel to operate as in the Digit Edit facility (*refer to Section 4, paras 4.4.2*).

#### **Front Panel Controls — Coarse Slewing Adjustments**

Most initial slewing operations will require steps of adjustment larger than a single digit. These coarser adjustments are available with the 'ENABLE CURSOR' key cancelled. Of the front panel keys, only the spinwheel and the ⤴ and ⤵ keys are enabled. The size of their increments and decrements are calculated internally.

*Final Width = 215mm*

*continued overleaf →*

*Final Width = 215mm*

---

## **5.2.4 Printing Setup**

The results of adjustment and verification operations on UUTs can be printed on one of two forms of certificate. A suitable printer must be connected and switched on-line, and the required certificate style, format and data must be entered into the 9500B memory. Then with the correct printer type enabled, the 9500B internal program will generate the required certificate.

### **5.2.4.1 Printer Type**

The printer to be used should be capable of printing 120 characters per line, and must be able to print the Code Page 437 character set. Most printers compatible with Epson FX, Canon Bubble-Jet or Hewlett-Packard Desk-Jet are suitable. The printer is connected to the 25-way D-type port on the 9500B rear panel.

### **5.2.4.2 Certificate Formatting and Data Presentation**

Config mode is used to select the style of certificate to be printed, and to set the format of page length, headers, footers, etc. In addition, such certificate entries as laboratory identification, temperature and humidity can be added. Details of these elements of Config mode can be found in *Section 3, paras 3.4.3*.

**Note:** If the Procedure Card used to run the procedure was originally written for the Model 9100 Option 250 or 600, then the procedure and certificate will incorporate the relevant 9100 (not 9500B) uncertainties.

### **5.2.4.3 Enable Printing**

Printing must be enabled, using the Config mode screen keys 'PRINTER' and the appropriate selection of printer type (*refer to Section 3, paras 3.4.3.5*).

## 5.2.5 Saving Results on Memory Cards

### Front Panel PCMCIA Slots

In Procedure mode, the procedures for adjustment and verification operations for UUTs are controlled from a pre-programmed memory card, inserted in the left PCMCIA SLOT 1 on the 9500B front panel. The results of these operations can be saved on Static RAM memory cards, inserted in the right PCMCIA SLOT 2. The 9500B 'Test' mode of operation can be used to erase SRAM cards containing old results, and initialize them as blank results cards (*refer to Section 8, paras 8.3.4.5*).

Although 'FLASH' cards are used to store procedures, they cannot be used for storing results.

### 5.2.5.1 Results Card Enabling and Insertion

#### Use of Config Mode

Config mode is used to enable results to be saved on memory cards. Details can be found in *Section 3, paras 3.4.3.17*.

#### Inserting the Card

Before the results can be saved, a memory card must be inserted into PCMCIA SLOT 2 and pressed firmly home. If a card is not present, a reminder will be given on the screen when the internal program attempts to write results.

#### Examine the Memory Card

The 68-way socket pins can be seen on the end of the card to be inserted:

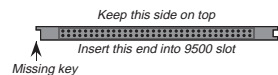

### Insert the Card

When inserting, the missing key must be located underneath the card on the right front:

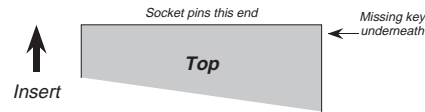

### Write-Protect Switch

The Static RAM cards can be write-protected by means of a small switch on the opposite end to the contact pins. Obviously this protection must be switched off before the 9500B can write results. If a card *is* write protected, a warning message will appear on the screen.

### Do Not Remove in Mid-Procedure

It is not necessary to insert a card before enabling, but once the card *is* inserted, it must *not* be removed until the procedure is ended or aborted. Such removal will corrupt data.

### 5.2.5.2 Stage-by-Stage Results Saving

The 9500B internal program will generate and save results at the conclusion of *each stage* in the UUT adjustment or verification procedure. The end of each stage is marked by the use of the 'OK', 'PASS' or 'FAIL' screen key on the front panel (or, of course, by the equivalent use of the tracker unit buttons).

### 5.2.5.3 Results Memory Space

After a 'Procedure' memory card is created, an estimate of the results memory requirement for each procedure is calculated and written on to the card.

When in use, before the first results for a procedure are written into the 'Results' card, the 9500B system will review the free memory space on the card. If this is less than 150% of the procedure's estimated results requirement, the user will be warned to insert a different card.

### 5.2.5.4 Static RAM Card — Non-Rechargeable Battery Condition

#### Battery Voltage Monitoring

Each Static RAM card is powered by its own battery which maintains the non-volatile status of its RAM. While a results card is present in PCMCIA SLOT 2, the 9500B continuously monitors the battery voltage state. When the voltage falls to approach a failure condition, a warning is given on the 9500B screen.

#### Changing the Battery

With the card present in PCMCIA SLOT 2, the RAM is powered from 9500B power supplies, so it is possible to pull out the battery module from the card and insert a new module without losing the stored data.

### 5.2.5.5 Static RAM Card — Rechargeable Battery

#### Battery Charging

Each Static RAM card is powered by its own battery which maintains the non-volatile status of its RAM. While a results card is present in PCMCIA SLOT 2, with the 9500B powered ON, the battery will be recharged. The specified recharge times are 8 hours to 60% capacity, and 40 Hours to 100% capacity. If the card battery charge is low when the card is inserted into PCMCIA SLOT 2, a low battery warning may be given on the 9500B screen, during the initial charge period of up to 40 seconds.

#### Battery Access and Life

The battery is not accessible to be changed in these cards, but the retention time between chargings is in excess of six months.

*Final Width = 215mm*

BLANK PAGE (LEFT-HAND)



## 5.3 Procedure Mode — Access Guide

### 5.3.1 Introduction

Sub-section 5.3 is a guide to access to Procedure Mode. The following topics are covered:

	Page
5.3.2 Mode Selection.	5.3-1
5.3.2.1 'Mode' Key.	5.3-1
5.3.2.2 'Mode Selection' Display.	5.3-1
5.3.3 Selection of Procedure Mode —	
Entry Menus Common to All Procedures.	5.3-1
5.3.3.1 PROC Key.	5.3-1
5.3.3.2 Procedure Mode Display at Entry.	5.3-1
5.3.3.3 Is Your Name on the List?.	5.3-1
5.3.3.4 Select and Insert the Procedure Card which contains the Procedure for the Subject UUT Model.	5.3-2
5.3.3.5 Select the Subject UUT Manufacturer.	5.3-3
5.3.3.6 Select the Subject UUT Model.	5.3-3
5.3.3.7 Enter the Serial Number of the Subject UUT.	5.3-3
5.3.3.8 Select the Procedure for the Subject UUT Model.	5.3-4
5.3.3.9 Procedures — Card-Based Operating Instructions.	5.3-4
5.3.3.10 'ABORT'.	5.3-5
5.3.3.11 'END'.	5.3-5
5.3.3.12 User Options Following 'ABORT' or 'END'.	5.3-6
5.3.3.13 Common Operations in Procedure Mode — Summary of Actions.	5.3-6

### 5.3.2 Mode Selection

(A flow chart summarizing the access to Procedures is given at paras 5.3.3.13 — Fig. 5.3.2)

#### 5.3.2.1 'Mode' Key

The five 'Modes' are accessed by pressing the 'Mode' key at the right of the front panel.

#### 5.3.2.2 'Mode Selection' Display

At power-on, the system defaults into either Procedure mode or Manual mode as previously programmed in 'Configure' mode. When 'Procedure' mode is required and the Configure default is 'Manual' mode, it will be necessary to transfer via the 'Mode' display.

By pressing the 'Mode' key, the system will present the Mode Selection menu screen for selection from the five modes (Fig 5.3.1).

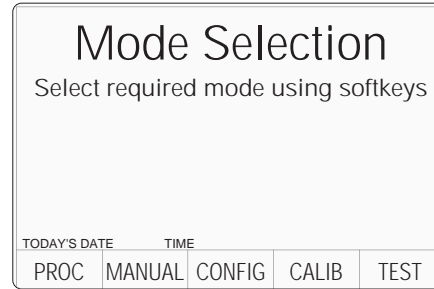

Fig. 5.3.1 Mode Selection Menu

The required mode is selected by pressing its appropriate screen key on the bottom row; then the 'Mode Selection' screen will be replaced by the mode's first menu screen (or in the case of Configure or Calibration mode, the password entry screen).

Press the **Mode** key on the right of the front panel to obtain the 'Mode Selection' menu screen

### 5.3.3 Selection of Procedure Mode — Entry Menus Common to All Procedures

#### 5.3.3.1 PROC Key

Procedure mode is entered by pressing the '**PROC**' screen key on the bottom row of the Mode Selection menu screen (or after Power On when the Procedure mode is set as the power-on default in Configuration mode).

#### 5.3.3.2 Procedure Mode Display at Entry

When Procedure mode has been successfully entered, the 9500B starts by presenting the 'Select USER NAME ...' display:

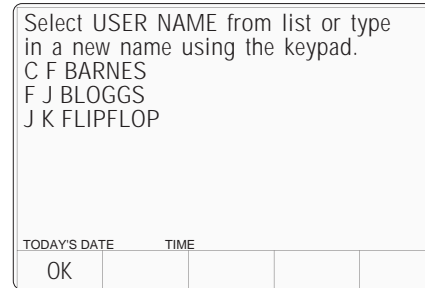

#### 5.3.3.3 Is Your Name on the List?

If you are on the list, use cursor keys to select your name, then press the 'OK' screen key.

#### If Your Name is NOT on the List:

Use the alpha-numeric keypad to write your name (12 characters max.) on the screen<sup>[1]</sup>. It will appear at the bottom of the screen as you type, together with a shift key icon. Then press the '↵' key or the 'OK' screen key, after which the screen will change to select the manufacturer or model to be tested, except that further progress will require a procedure card to be inserted into PCMCIA SLOT 1 (refer to paras 5.3.3.4).

The list can be cleared only by entering **CONFIG** Mode, using the password and pressing the '**MORE**' screen key, then using the '**CLEAR USER LIST**' facility.

#### [1] Writing Alphabetical Characters

For alphabetical characters, there are two shift keys: '▲' (blue — left) and '■' (red — right) on the bottom row of the keypad. The numeric keys have colour-coded alphabetical characters printed on left and right. Press and release the appropriate shift key then the alphabetic character key in order to spell out the words.

Only **UPPER CASE** characters are available from the keypad.

Final Width = 215mm

Final Width = 215mm

**5.3.3.4 Select and Insert the Procedure Card which contains the Procedure for the Subject UUT Model**

**a. No Procedure Card in Slot, and no Procedures Downloaded**

Up to now, there has been no need to use the Procedure memory card. After this point, the 9500B needs to extract information from the card, so the card required for the UUT must be inserted into PCMCIA SLOT 1, and pushed firmly home. But first:

**Examine the Memory Card**

The 68-way socket pins can be seen on the end of the card to be inserted:

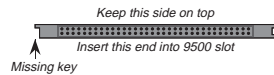

**Insert the Card**

When inserting, the missing key must be located underneath the card on the right front:

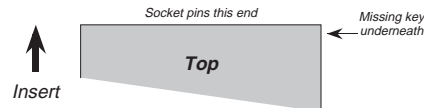

If no Procedure Card has yet been inserted into the slot, and no procedure is at present resident in the RAM, (see 5.3.3.6), then the following message will appear on the screen:

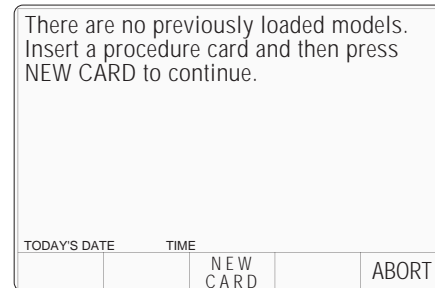

In this case, insert the card required for the UUT into PCMCIA SLOT 1, push gently home, and press the 'NEW CARD' screen key for the sequence to continue.

The 9500B will transfer to the 'Select MANUFACTURER' menu screen if more than one manufacturer is listed in the procedure card, or to 'Select MODEL' screen if only one manufacturer is listed.

**b. No Procedure Card in Slot, but a UUT Model's Procedures Resident in RAM**

If, on a previous occasion since the most-recent power-on, a UUT model was selected from the Select Model screen menu, the 9500B will have downloaded all the procedures for the selected model into internal RAM.

If, on this occasion, no Procedure memory card has yet been inserted into the slot, and procedures are still resident in the RAM, (see 5.3.3.6), then a message similar to the following will appear on the screen:

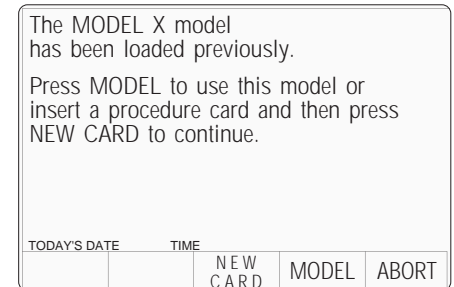

A choice is given: whether to use the loaded procedures, or to insert a new card to load a different model's procedures.

**For the same model**, merely press the 'MODEL' screen key and the 9500B will transfer to the 'Enter the SERIAL NUMBER ...' screen.

**For a different model**, insert the card required for the UUT into PCMCIA SLOT 1, push firmly home, and press the 'NEW CARD' screen key for the sequence to continue.

After pressing 'NEW CARD', the 9500B will transfer to the 'Select MANUFACTURER' menu screen if more than one manufacturer is listed in the procedure card, or to 'Select MODEL' screen if only one manufacturer is listed.

**ABORT** returns to the 'Select USER NAME ...' screen.

Refer to paras 5.3.3 13, Fig 5.3.2.

### 5.3.3.5 Select the Subject UUT Manufacturer

*(Only available if more than one manufacturer is listed in the Procedure Card)*

By the time the 'Select MANUFACTURER' screen has been successfully opened, the 9500B will have extracted a list of the manufacturers whose models' procedures are contained in the Procedure card memory. These it displays on the screen for the user to choose. For example:

Select MANUFACTURER using cursor keys. Press NEW CARD to read another card.			
MANUF 1			
MANUF 2			
TODAY'S DATE	TIME	NEW CARD	ABORT

#### If the wrong card has been inserted:

Remove that card, insert another, then press the NEW CARD screen key to tell the 9500B that a different card has been inserted.

#### More than one manufacturer listed in the new card:

The 9500B lists the manufacturers whose models' procedures are resident in the new card

#### Only one manufacturer listed in the new card:

The 9500B transfers to the 'Select MODEL' screen if only one manufacturer is listed.

#### Correct manufacturer selected:

After selecting the required manufacturer, pressing the OK screen key will cause the 9500B to transfer to the 'Select MODEL' menu screen.

**ABORT** returns to the 'Select USER NAME ...' screen. Refer to *paras 5.3.3 13, Fig 5.3.2.*

### 5.3.3.6 Select the Subject UUT Model

By the time the 'Select MODEL' screen has been successfully opened, the 9500B will have extracted a list of the models whose procedure is contained in the Procedure card memory. These it displays on the screen for the user to choose. For example:

Select MODEL using cursor keys. Press NEW CARD to read another card.			
MODEL 1			
MODEL 2			
TODAY'S DATE	TIME	NEW CARD	ABORT

#### If the wrong card has been inserted:

Remove that card, insert another, then press the NEW CARD screen key to tell the 9500B that a different card has been inserted.

#### More than one manufacturer listed in the new card:

The 9500B lists the manufacturers whose models' procedures are resident in the new card. After selecting the required manufacturer using the cursor keys, pressing the OK screen key will cause the 9500B to transfer to the 'Select MODEL' menu screen.

#### Only one manufacturer listed in the new card:

The 9500B transfers to the 'Select MODEL' screen if only one manufacturer is listed.

#### Correct Model selected:

After selecting the required model, pressing the OK screen key will cause the 9500B to download all the procedures for that model into internal RAM. The card can then be removed and used to load another instrument.

After choosing the model, the next stage is to enter the UUT serial number. Pressing the 'OK' screen key will cause the 9500B to transfer to the 'Serial Number' screen.

**ABORT** returns to the 'Select USER NAME ...' screen.

Refer to *paras 5.3.3 13, Fig 5.3.2.*

### 5.3.3.7 Enter the Serial Number of the Subject UUT

Having selected the UUT model, the 9500B asks for the serial number to be entered so that any results can be identified. This is done on the following screen:

Enter the SERIAL NUMBER of UUT. Confirm with OK.			
Serial Number :			
TODAY'S DATE	TIME		ABORT

#### Enter the UUT's Serial Number:

Use the alpha-numeric keypad to write the serial number (20 characters max.) on the screen. It will appear at the bottom of the screen as you type. Then press the '↵' key or the 'OK' screen key, after which the screen will change to select the type of procedure required

**ABORT** returns to the 'Select USER NAME ...' screen.

Refer to *paras 5.3.3 13, Fig 5.3.2.*

*Final Width = 215mm*

### 5.3.3.8 Select the Procedure for the Subject UUT Model

When the 'Select PROCEDURE' screen is opened, the 9500B will have already downloaded all the procedures for the selected model from the Procedure card memory into internal RAM. The 9500B displays a list of these on the screen for the user to choose:

Select PROCEDURE using cursor keys. Confirm with OK.			
<b>Adjustment Only</b>			
1 Year Verification			
ISO9000 Verify			
Verify Pass/Fail			
ISO9000 Pass/Fail			
TODAY'S DATE		TIME	
OK			ABORT

Final Width = 215mm

#### Types of Procedure

(Procedure Cards supplied from the Procedure Library)

Variants of three basic procedures (Adjustment Only, 1 Year Verification and Verify Pass/Fail) can be found in the Procedure cards available in the manufacturer's UUT Calibration Procedure Library (*sub-section 1.4*).

#### Adjustment Only

The procedure will cause the 9500B to provide the correct outputs for each of the Manufacturer's recommended test points for adjustment of the subject UUT model. The identity of adjustment controls, target values and limits are presented on the screen for the convenience of the user, who will also decide whether the adjustment was successful, and record pass/fail status. The procedure is described in *sub-section 5.4*.

#### 1 Year Verification

The 9500B provides the correct outputs for each of the Manufacturer's recommended test points used to verify the full performance of the subject UUT model. Users can slew the output to determine the UUT error. 'Style 1' printed results will list these errors. The procedure is described in *sub-section 5.5*.

#### ISO9000 Verify

This is a variant of 1 Year Verification, different in that the 9500B provides a wider range of test points to verify performance in greater detail than is recommended by the Manufacturer.

#### Verify Pass/Fail

The 9500B provides the correct outputs at each of the test points, for the user to check whether the UUT verifies within its specification. Pass/Fail only is printed on the report. The procedure is described in *sub-section 5.6*.

#### ISO9000 Pass/Fail

This is a variant of Verify Pass/Fail, different in that the 9500B provides a wider range of test points to check the specification in greater detail than is recommended by the Manufacturer.

#### To Select a Procedure

Use the  $\odot$  and  $\ominus$  cursor keys, or the spinwheel to highlight the required procedure, then press 'OK'. The 9500B will transfer to the appropriate menu screen. Refer to the procedure description.

**ABORT** returns to the 'Select USER NAME ...' screen.

Refer to *paras 5.3.3 13, Fig 5.3.2*.

### 5.3.3.9 Procedures — Card-Based Operating Instructions

#### Selection of UUT Model

When the model of UUT has been chosen from the menu (derived from the procedure card), all procedures for the selected model are automatically downloaded into the 9500B's internal memory, and the selected procedure no longer requires the card, as it will be programmed from the internal memory. Once the procedure has progressed this far, the procedure card can be removed and used to program other Model 9500B units.

#### Procedure Activation

Once the type of procedure has been selected, the downloaded user-interactive program will be run by the 9500B. Subsequent instructions appearing on the screen will be derived from the programmed sequences.

#### Single-Channel Variants - Procedures

This description assumes that the variant 9500B/1100 is being used.

#### Conclusion

No further routine instructions are given here, as they may vary from model to model and are developed within the programmed sequences. However, the 9500B is programmed also to interrupt procedures and communicate with the user when certain events occur. Among these, the two most important are those of 'Abort' and 'End'.

### 5.3.3.10 'ABORT'

Up to this point of choosing a procedure, when an 'ABORT' screen key is pressed, the system will revert to the first Procedure-mode screen 'Select USER NAME'.

After the choice of procedure has been confirmed by 'OK', the procedure itself is controlled from the card sequence, and when an 'ABORT' screen key is pressed, the system will generate a special 'ABORT' message which also ends the procedure, overwriting the currently-displayed screen:

This procedure has been ABORTED . . . Please select one of the softkeys below.				
TODAY'S DATE		TIME		
OK				ABORT

The procedure can be aborted by the 9500B itself for other reasons. This will also invoke the 'ABORT' screen.

For the choices obtained from the five screen keys, refer to *paras 5.3.3.12*.

### Removal of Active Head

If the 'in use' Active Head is removed during a procedure, this will be detected and a message will appear on the screen:

Please ensure that these heads are correctly inserted: Channel X: Head Num 1234567 Channel Y: Head Num 7654321				
TODAY'S DATE		TIME		
OK				ABORT

The head serial numbers are given. 'Channel X' refers to the selected signal channel, and 'Channel Y' is the selected trigger channel. If no head was fitted, then the words 'Any Head' will appear in place of the head number.

If the procedure card was produced for use with the Model 9100 Option 250 or 600, then no channels will have been nominated in the procedure. In this case the 9500B will choose the channel which was most-recently used, and it will be this which appears on the screen.

Pressing **OK** will cause the 9500B to pass on to the next operation in sequence, only after the appropriate heads have been connected to the selected channels. Otherwise the operator can choose **ABORT**, which will return to the previous start point.

### 5.3.3.11 'END'

When all stages of the procedure have been completed, the system will end the procedure, also generating a special 'END' message which overwrites the currently- displayed screen:

The procedure has ended. Please select one of the softkeys below.				
TODAY'S DATE		TIME		
USER	MODEL	SERIAL	PROC	RETRY

For the choices obtained from the five screen keys, refer to *paras 5.3.3.12*.

*continued overleaf* →

*Final Width = 215mm*

Final Width = 215mm

### 5.3.3.12 User Options Following 'ABORT' or 'END'

Once the procedure has ended or been aborted, the user can return to one of five points in the sequence. The point numbers refer to Fig 5.3.2:

#### USER (Point 1)

The 'Select USER NAME' screen is the first to appear after selecting Procedure mode. All setup parameter variables can be changed, and a new procedure card can be inserted.

#### MODEL (Point 2)

The 'Select MODEL' screen offers user-selection from all the UUT models (for the previously-selected manufacturer) on the currently-loaded procedure card; or a new procedure card can be inserted.

**Note:** For those cards containing procedures for UUTs from more than one manufacturer: then in order to change manufacturer, return to the 'Select USER NAME' screen by pressing the 'USER' screen key.

#### SERIAL (Point 3)

This choice assumes a wish to select a different unit of the same model. The system therefore returns to the 'Enter SERIAL NUMBER' screen.

#### PROC (Point 4)

This choice assumes a wish to select a different procedure for the same model and serial number. The system therefore returns to the 'Select PROCEDURE' screen.

#### RETRY (Point 5)

This selection re-runs the same procedure which has just ended or been aborted. It is assumed that the same unit is being tested, so the same serial number will appear on any results print-out.

### 5.3.3.13 Common Operations in Procedure Mode — Summary of Actions

The flow chart in Fig. 5.3.1 summarizes the user actions needed to enter Procedure mode and load the procedure card; then select the UUT model and its pre-programmed procedures:

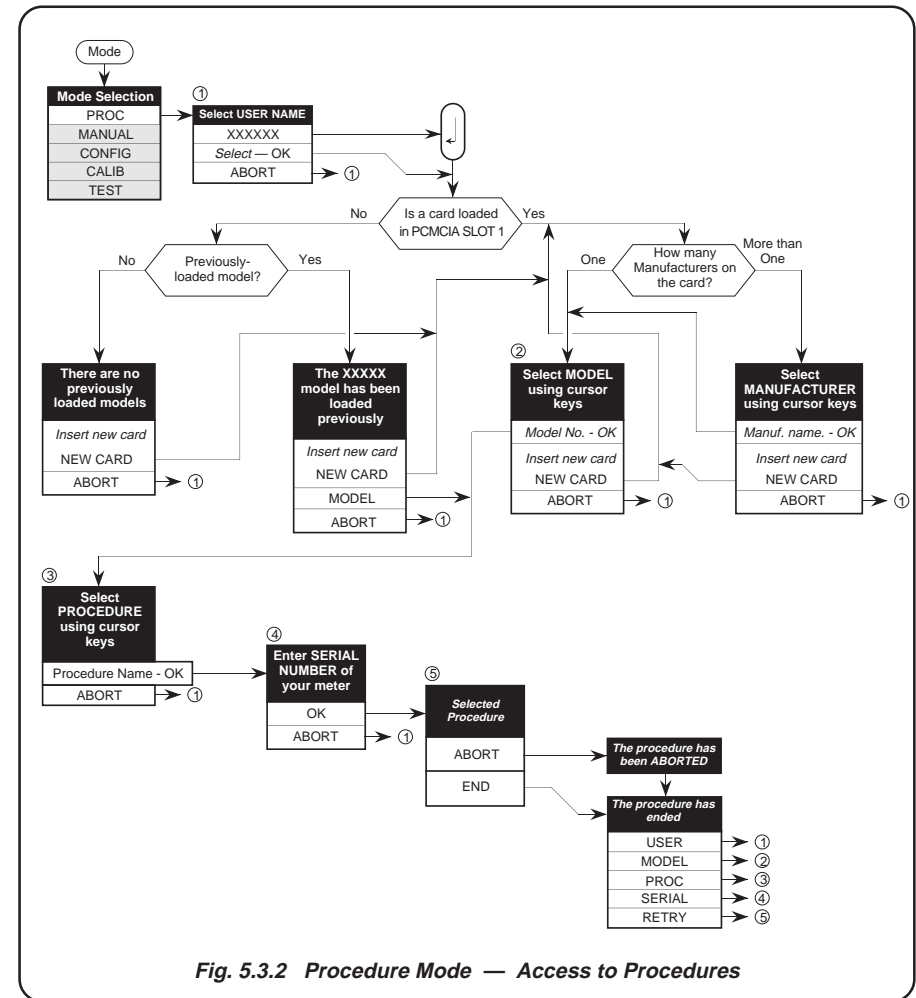

Fig. 5.3.2 Procedure Mode — Access to Procedures

## Section 6: 9500B System Application via IEEE-488 Interface

### 6.1 About Section 6

Section 6 describes the environment in which the Model 9500B will operate in remote applications, using the SCPI (Standard Commands for Programmable Instruments) language, within the IEEE-488.1 remote interface. In Section 6 we shall show how the 9500B adopts the IEEE-488.2 message-exchange model and reporting structure, and define the SCPI commands and syntax used to control the 9500B. Section 6 is divided into the following sub-sections:

6.2	Index of IEEE-488.2 and SCPI Codes used in the 9500B .....	6.2-1	6.5	Retrieval of Device Status Information. <i>9500B 'SCPI' Status Reporting Structure, based on IEEE-488.2.</i>	
6.2.1	Common IEEE 488.2 Commands and Queries. ....	6.2-1	6.5.1	General. ....	6.5-1
6.2.2	9500B SCPI Subsystems .....	6.2-1	6.5.2	IEEE-488 and SCPI Standard-Defined Features. ....	6.5-1
6.3	Introduction <i>9500B System Operational Parameters.</i>		6.5.2.1	Status Summary Information and SRQ .....	6.5-1
6.3.1	Interface Capability. ....	6.3-1	6.5.2.2	Event Register Conditions .....	6.5-1
6.3.1.1	IEEE Standards 488.1 and 488.2 .....	6.3-1	6.5.2.3	Access via the Application Program .....	6.5-1
6.3.1.2	The 9500B in IEEE 488.2 Terminology. ....	6.3-1	6.5.3	9500B Status Reporting — IEEE-488.2 Basics. ....	6.5-3
6.3.1.3	Programming Options .....	6.3-1	6.5.3.1	IEEE 488.2 Model .....	6.5-3
6.3.1.4	Capability Codes .....	6.3-1	6.5.3.2	9500B Model Structure .....	6.5-3
6.3.1.5	Bus Addresses .....	6.3-1	6.5.3.3	Status Byte Register .....	6.5-3
6.3.1.6	Limited Access .....	6.3-1	6.5.3.4	Service Request Enable Register .....	6.5-4
6.3.2	Interconnections. ....	6.3-2	6.5.3.5	IEEE 488.2-defined Event Status Register .....	6.5-4
6.3.3	SCPI Programming Language. ....	6.3-2	6.5.3.6	Standard Event Status Enable Register .....	6.5-5
6.4	Using the 9500B in a System <i>9500B System — Infrastructure.</i>		6.5.3.7	The Error Queue .....	6.5-5
6.4.1	Addressing the 9500B. ....	6.4-1	6.5.4	9500B Status Reporting — SCPI Elements. ....	6.5-6
6.4.1.1	Accessing the Bus Address .....	6.4-1	6.5.4.1	General .....	6.5-6
6.4.1.2	Select 'Configuration' Mode .....	6.4-1	6.5.4.2	SCPI Status Registers .....	6.5-6
6.4.1.3	Select 'MORE' Parameters .....	6.4-1	6.5.4.3	Reportable SCPI States .....	6.5-6
6.4.1.4	Enter Your Password .....	6.4-1	6.6	9500B SCPI Language — Commands and Syntax. <i>Detailed treatment of the 9500B SCPI Command Set For an index to pages of individual commands, refer to Sub-Section 6.2.</i>	
6.4.1.5	Change the Bus Address .....	6.4-1	6.6.1	Introduction. ....	6.6-1
6.4.2	Operation via the IEEE-488 Interface. ....	6.4-2	6.6.2	CALibration Subsystem .....	6.6-2
6.4.2.1	General .....	6.4-2	6.6.3	OUTPut Subsystem. ....	6.6-3
6.4.2.2	Operating Conditions .....	6.4-2	6.6.4	ROUTe Subsystem. ....	6.6-5
6.4.2.3	Programmed Transfer to Local Control (GTL or REN False) .....	6.4-2	6.6.5	SOURce Subsystem. ....	6.6-7
6.4.2.4	'Device Clear' .....	6.4-2	6.6.6	CONFIgure Subsystem. ....	6.6-15
6.4.2.5	Levels of Reset .....	6.4-2	6.6.7	STATus Subsystem. ....	6.6-16
6.4.3	Message Exchange. ....	6.4-3	6.6.8	SYSTem Subsystem. ....	6.6-18
6.4.3.1	IEEE 488.2 Model .....	6.4-3	Appendix A:	<i>IEEE 488.2 Device Documentation Requirements.</i> .....	6-A1
6.4.3.2	9500B Status Subsystem .....	6.4-3	Appendix C:	<i>IEEE 488.2 Common Commands and Queries.</i> .....	6-C1
6.4.3.3	Incoming Commands and Queries .....	6.4-3	Appendix D:	<i>Device Settings after *RST (Reset).</i> .....	6-D1
6.4.3.4	9500B Functions and Facilities .....	6.4-4	Appendix F:	<i>Model 9500B — Emulation of Tektronics SG5030 and CG5010/5011</i> .....	6-F1
6.4.3.5	Outgoing Responses .....	6.4-4			
6.4.3.6	'Query Error' .....	6.4-4			
6.4.4	Request Service (RQS). ....	6.4-4			
6.4.4.1	Reasons for Requesting Service .....	6.4-4			
6.4.4.2	RQS in the IEEE 488.2 Model .....	6.4-4			

*Final Width = 215mm*

BLANK PAGE (LEFT-HAND)



## 6.2 Index of IEEE 488.2 and SCPI Codes used in the 9500B

### 6.2.1 Common IEEE 488.2 Commands and Queries

Program Coding	Description	Appendix C, Page:	Program Coding	Description	Appendix C, Page:
*CLS	Clears event registers and queues (not O/P queue)	6-C1	*PSC 0/1	Sets/resets power-on status clear flag	6-C7
*ESE Nrf	Enables standard-defined event bits	6-C2	*PSC?	Recalls power-on status clear flag	6-C8
*ESE?	Returns ESE register mask value	6-C2	*PUD	Allows entry of user data to protected store	6-C9
*ESR?	Reads Event Status register	6-C3	*PUD?	Recalls user-entered data	6-C10
*IDN?	Reports manufacturer, model, etc.	6-C4	*RST	Resets instrument to power on condition	6-C11 / App D, p6-D1
*OPC	Sets the 9500B to monitor the 'No-Operations-Pending' flag	6-C5	*SRE Nrf	Enables Service Request Byte bits	6-C11
			*SRE?	Returns Service Request Byte mask value	6-C12
*OPC?	For 'No-Operations-Pending' flag 'TRUE', places a 1 in the Output Queue.	6-C5	*STB?	Non-destructively reads Service Request Byte	6-C12
*OPT?	Recalls the instrument's option configuration.	6-C6	*TST?	Perform Full Test	6-C13
			*WAI	Conforms, but little relevance to 9500B application	6-C14

### 6.2.2 9500B SCPI Subsystems

		Page:
CALibration	Used to calibrate the functions and hardware ranges of the 9500B, correcting for system errors which have accumulated due to drift and ageing effects:	6.6-2
SECure	:PASSword. Gains access to Calibration operations, using 'Cal Enable' switch and Password. . :EXIT. Permits clean exit from calibration operation	6.6-2
TARGET	Sets up the calibration target point.	6.6-2
TRIGger?	Initiates the calibration at a single point (TARGET), once the target and levels have been set up, and returns '0' for pass, and '1' for fail	6.6-3
SPECial	Runs various calibration characterizations, calculations and procedures	6.6-3
HEAD:STORE?	Initiates storage of head calibration data	6.6-4
OUTPut	Used to control parameters associated with output connections:	6.6-4
[STATE] (?)	Controls output on/off switching	6.6-4
ROUTE	Used to define the output channels which are associated with signal and trigger outputs:	6.6-5
FITTed?	Returns the type of head or cable or neither, associated with each channel.	6.6-5
SIGNal[:PATH]	Defines the channel to be used as signal output path	6.6-5
SIGNal:IMPedance	Defines the expected load impedance of the selected signal channel	6.6-5
SIGNal:SKEW	Defines and selects the signal channels to be used in Skew function	6.6-5
SIGNal:DUAL	Used in Sine function. Selects the two signal channels to be used in Dual operation	6.6-6
TRIGger[:PATH]	Defines the channel to be used as trigger output path	6.6-6
TRIGger:IMPedance	Defines the expected load impedance of the selected trigger channel	6.6-6
TRIGger:RATio(?)	Sets the ratio of trigger to signal frequency: +1, +10, +100.	6.6-6

*Final Width = 215mm*

*continued overleaf →*

**6.2.2 9500B SCPI Subsystems** (Contd.)

[SOURce]	Used to select the main 9500B Function to be output: .....	6.6-7		
	:FUNction	Selects the Waveshape of output signals .....	6.6-8	
	:SCOpe	Backward compatibility with 9100 Opt. 250 .....	6.6-8	
		[:SHAPe](?)	Selects the Waveshape of output signals .....	6.6-8
		:TRANsition(?)	Selects the direction of the important edge .....	6.6-9
		:UUT_Z(?)	Selects impedance matching for signal and trigger channels .....	6.6-13
		:SPERiod(?):[CW FIXed](?)	Sets the period of the currently-selected waveform .....	6.6-14
	:PARAmeter	:DC	Subsequent selection of VOLT or CURR will have DC component only .....	6.6-8
		:DC:GROund	Subsequent output of VOLT or CURR will be grounded .....	6.6-8
		:DC:MCHannel	Enables/disables multichannel output .....	6.6-8
		:SQUare	Subsequent selection of VOLT or CURR will have square waveshape .....	6.6-9
		:SQUare:POLarity	Sets the polarity of the selected squarewave .....	6.6-9
		:SQUare:GROund	Subsequent output of VOLT or CURR will be grounded .....	6.6-9
		:EDGE	Sets edge direction and speed in 'Edge' function .....	6.6-9
		:MARKer	Sets waveforms in 'Timing Marker' function .....	6.6-10
		:OPULse	Sets the pulse amplitude and energy used to test overload protection of oscilloscopes and executes transmission .....	6.6-10
		:RAMP	Sets ramp time and trigger point in 'Linear Ramp' function .....	6.6-11
		:SKEW	Enables/disables precision alignment in Zero Skew function .....	6.6-11
		:TELevision	Selects TV line standard, sync standard, video level and polarity in Composite Video function .....	6.6-11
		:LEAKage	Selects open/closed conditions and triggers used to determine the UUT oscilloscope's input leakage current .....	6.6-12
		:EXTernal	Selects the 'Auxiliary Input' signal .....	6.6-13
	VOLTage	Selects the Voltage source, and sets output amplitude .....	6.6-13	
	CURRent	Selects the Current source, and sets output amplitude .....	6.6-14	
	FREQuency	Controls the Output Frequency value for AC functions .....	6.6-14	
	PERiod	Controls the Output Period value for AC functions .....	6.6-14	
	WIDTh	Controls the width of the pulse for Pulse Width functions .....	6.6-14	
CONFigure	Selects the resistance or capacitance measurement function .....	6.6-15		
READ?	Returns the most-recent resistance or capacitance measurement value .....	6.6-15		
STATus	Gives access to the 9500B SCPI-defined Status Reporting Structure: .....	6.6-16		
	OPERation	Reads from, or writes to, the OPERation Status Register .....	6.6-16	
	QUESTionable	Reads from, or writes to, the QUESTionable Status Register .....	6.6-17	
	PRESet	Presets a default status reporting condition .....	6.6-17	
SYSTem	Collects general functions that are not related to 9500B performance: .....	6.6-18		
	ERRor?	Requests the next entry from the 9500B error queue. ....	6.6-18	
	DATE(?)	Reads or writes the present date .....	6.6-18	
	TIME(?)	Reads or writes the present time .....	6.6-19	
	SVOLTage(?)	Reads or writes the Safety Threshold Voltage in DC or AC Voltage function .....	6.6-19	
	VERSion?	Returns a numeric value corresponding to the SCPI version for which the instrument complies ..	6.6-19	
	FORMat?	Returns the present date format, as programmed locally .....	6.6-19	

*Final Width = 215mm*

## 6.3 Introduction

This first part of Section 6 gives the information necessary to put the 9500B into operation on the IEEE 488 bus. For more detailed information, refer to the standard specification in the publications ANSI/IEEE Std. 488.1-1987 and IEEE Std. 488.2-1988.

### 6.3.1 Interface Capability

#### 6.3.1.1 IEEE Standards 488.1 and 488.2

The 9500B conforms to the Standard Specification IEEE 488.1-1987: 'IEEE Standard Digital Interface for Programmable Instrumentation', and to IEEE 488.2-1988: 'Codes, Formats, Protocols and Common Commands'.

#### 6.3.1.2 The 9500B in IEEE 488.2 Terminology

In IEEE 488.2 terminology the 9500B is a **device** containing a **system interface**. It can be connected to a **system** via its **system bus** and set into programmed communication with other bus-connected **devices** under the direction of a system **controller**.

#### 6.3.1.3 Programming Options

The instrument can be programmed via the IEEE Interface, to:

- Change its operating state (Function, Source, etc).
- Transmit its own status data over the bus.
- Request service from the system controller.

#### 6.3.1.4 Capability Codes

To conform to the IEEE 488.1 standard specification, it is not essential for a device to encompass the full range of bus capabilities. For IEEE 488.2, the device must conform exactly to a specific subset of IEEE 488.1, with a minimal choice of optional capabilities.

The IEEE 488.1 document describes and codes the standard bus features, for manufacturers to give brief coded descriptions of their own

interfaces' overall capability. For IEEE 488.2, this description is required to be part of the device documentation. A code string is often printed on the product itself.

The codes which apply to the 9500B are given in table 6.1, together with short descriptions. They also appear on the rear of the instrument next to the interface connector. These codes conform to IEEE 488.2 requirements.

IEEE 488.1 Subset	Interface Function
SH1	Source Handshake Capability
AH1	Acceptor Handshake Capability
T6	Talker (basic talker, serial poll, unaddressed to talk if addressed to listen)
L4	Listener (basic listener, unaddressed to listen if addressed to talk)
SR1	Service Request Capability
RL1	Remote/Local Capability (incl. Local Lockout)
PP0	No Parallel Poll Capability
DC1	Device Clear Capability
DT0	No Device Trigger Capability
C0	No Controller Capability
E2	Open-Collector and Three-State Drivers

**Table 6.1**  
**9500B IEEE 488.1 Interface Capability**

Appendix C of the IEEE 488.1 document contains a fuller description of each code.

#### 6.3.1.5 Bus Addresses

When an IEEE 488 system comprises several instruments, a unique 'Address' is assigned to each to enable the controller to communicate with them individually.

The 9500B has two primary addresses (*refer to Para. 6.4.1.5, and Section 6, Appendix F*), which can be set by the user to exclusive values within the range from 0 to 30 inclusive. They cannot be made to respond to any address outside this range. Secondary addressing is not available. The application program adds data to the active address, to define 'talk' or 'listen'. The method of setting addresses, and the point at which the new user-initiated address is recognized by the 9500B, is given in *Sub-Section 6.4.1*.

#### 6.3.1.6 Limited Access

The 9500B has five main modes, which are described briefly in *Volume 1 of this Handbook, Section 1, Sub-section 1.2.2*. Remote operation is subject to the following limitations:

- **Procedure Mode**

When the 9500B is in Procedure Mode, it is driven essentially from the front panel. Remote Operation will not be allowed in this mode.

**N.B.** The 9500B can be powered up in either Manual mode or Procedure mode, as set locally in Configuration mode.

- **Manual Mode**

Remote operation is available for each Manual mode function, but for ease of programming, some remote commands do not mirror front panel operations exactly.

- **Configuration Mode**

Remote operation is not available, and configuration commands have not been included in the SCPI commands for the 9500B.

- **Calibration Mode**

Remote operation is available, but refer to *Sub-section 6.6.2* for details of entry protection.

- **Test Mode**

Remote operation is not available, but the 'Full' selftest can be initiated by a SCPI command. The 9500B will give a Pass/Fail response, but to investigate further, it is necessary to re-run Test mode from the front panel.

*Final Width = 215mm*

### 6.3.2 Interconnections

Instruments fitted with an IEEE 488 interface communicate with each other through a standard set of interconnecting cables, as specified in the IEEE 488.1 Standard document.

The IEEE-488 interface socket is fitted on the rear panel. It accommodates the specified connector, whose pin designations are also standardized as shown in Table 6.2

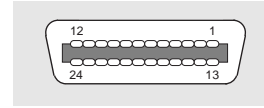

IEEE-488 Interface Socket - Pin Layout

Final Width = 215mm

Pin No.	Name	Description
1	DIO 1	Data Input/Output Line 1
2	DIO 2	Data Input/Output Line 2
3	DIO 3	Data Input/Output Line 3
4	DIO 4	Data Input/Output Line 4
5	EOI	End or Identify
6	DAV	Data Valid
7	NRFD	Not Ready For Data
8	NDAC	Not Data Accepted
9	IFC	Interface Clear
10	SRQ	Service Request
11	ATN	Attention
12	SHIELD	Screening on cable (connected to 9500B safety ground)
13	DIO 5	Data Input/Output Line 5
14	DIO 6	Data Input/Output Line 6
15	DIO 7	Data Input/Output Line 7
16	DIO 8	Data Input/Output Line 8
17	REN	Remote Enable
18	GND 6	Gnd wire of DAV twisted pair
19	GND 7	Gnd wire of NRFD twisted pair
20	GND 8	Gnd wire of NDAC twisted pair
21	GND 9	Gnd wire of IFC twisted pair
22	GND 10	Gnd wire of SRQ twisted pair
23	GND 11	Gnd wire of ATN twisted pair
24	GND	9500B Logic Ground (internally connected to Safety Ground)

Table 6.2 Connector J101 - Pin Designations

### 6.3.3 SCPI Programming Language

Standard Commands for Programmable Instruments (SCPI) is an instrument command language which goes beyond IEEE 488.2 to address a wide variety of instrument functions in a standard manner.

IEEE 488.2 defines sets of Mandatory Common Commands and Optional Common Commands along with a method of Standard Status Reporting. The 9500B implementation of SCPI language conforms with all IEEE-488.2 Mandatory Commands but not all Optional Commands. It conforms with the SCPI-approved Status Reporting method.

**Note:** Commands in SCPI language, prefaced by an asterisk (eg: \*CLS), are IEEE-488.2 standard-defined 'Common' commands.

Conformance of the 9500B remote programming commands to SCPI ensures that the 9500B has a high degree of consistency with other conforming instruments. For most specific commands, such as those relating to frequency and voltage, the SCPI approved command structure already exists and has been used wherever possible.

SCPI commands are easy to learn, self-explanatory and account for a wide variety of usage skills. A summary of the 9500B commands is given in sub-section 6.2. The full range of 9500B commands, with their actions and meanings in the 9500B, is detailed in alphabetical order in sub-Section 6.6, with conformance information in Appendix B to this section. The IEEE-488 Common Commands implemented in the 9500B, together with their operating information are given in Appendix C to this section.

## 6.4 Using the 9500B in a System

### 6.4.1 Addressing the 9500B

#### 6.4.1.1 Accessing the Bus Address

The instrument address can only be set manually; using the **Bus Address** menu, which is accessed via the **Configuration** menus.

**N.B.** A password is required for access to change the bus address.

#### 6.4.1.2 Select 'Configuration' Mode

1. Press the **Mode** key on the right of the front panel to obtain the 'Mode Selection' menu screen:

<h2 style="margin: 0;">Mode Selection</h2> <p style="margin: 0;">Select required mode using softkeys</p>														
<table border="1" style="width: 100%; border-collapse: collapse;"> <tr> <td style="font-size: small;">TODAY'S DATE</td> <td style="font-size: small;">TIME</td> <td colspan="3"></td> </tr> <tr> <td style="text-align: center;">PROC</td> <td style="text-align: center;">MANUAL</td> <td style="text-align: center;">CONFIG</td> <td style="text-align: center;">CALIB</td> <td style="text-align: center;">TEST</td> </tr> </table>					TODAY'S DATE	TIME				PROC	MANUAL	CONFIG	CALIB	TEST
TODAY'S DATE	TIME													
PROC	MANUAL	CONFIG	CALIB	TEST										

2. Press the **CONFIG** screen key at the center of the bottom row to progress into 'Configuration' mode. The 9500B will transfer to the open 'Configuration' information screen:

<h2 style="margin: 0;">Configuration</h2>														
Ser. No. XXXXXX		Rev. XXX												
Options : 1.1 GHz		Normal xtal												
Present Settings:														
Ref frequency	50.000 kHz													
Safety Voltage	100.00 V													
Bus Address	1													
Printer	NONE													
Power-up mode	Manual													
Ext ref in	10 MHz													
Ext ref in	Disabled													
<table border="1" style="width: 100%; border-collapse: collapse;"> <tr> <td style="font-size: x-small;">TODAY'S DATE</td> <td style="font-size: x-small;">TIME</td> <td colspan="3"></td> </tr> <tr> <td style="text-align: center;">EXIT</td> <td></td> <td></td> <td></td> <td style="text-align: center;">MORE</td> </tr> </table>					TODAY'S DATE	TIME				EXIT				MORE
TODAY'S DATE	TIME													
EXIT				MORE										

#### Note: Address Recognition

With an address selected in the range 0 to 30; control may be manual, or remote as part of a system on the Bus. The address must be the same as that used in the controller program to activate the 9500B. The 9500B is always aware of its stored address, responding to Talk or Listen commands from the controller at that address. When the address is changed by the user, the 9500B recognizes its new address and ignores its old address, as soon as it is stored by the user pressing the **EXIT** key in the **Configuration — Bus Address** menu.

#### 6.4.1.3 Select 'MORE' Parameters

The bus address is accessed by pressing the **'MORE'** soft key. By trying to select **'MORE'**, the 'Configuration' password will be required. The 9500B will transfer to the 'Password Entry' screen. (Refer to Section 3, sub-sections 3.4.2 and 3.4.3.)

<h2 style="margin: 0;">Password Entry</h2> <p style="margin: 0;">For Configuration</p>														
<p style="margin: 0;">Enter password : ☺☺☺☺☺☺</p>														
<table border="1" style="width: 100%; border-collapse: collapse;"> <tr> <td style="font-size: x-small;">TODAY'S DATE</td> <td style="font-size: x-small;">TIME</td> <td colspan="3"></td> </tr> <tr> <td style="text-align: center;">EXIT</td> <td></td> <td></td> <td></td> <td></td> </tr> </table>					TODAY'S DATE	TIME				EXIT				
TODAY'S DATE	TIME													
EXIT														

#### 6.4.1.4 Enter Your Password

1. When you enter your password using the alpha-numeric keyboard, security icons will appear on the screen as you type. Finally press the ↵ (return) key.

If the password is incorrect: an error message will be given and the security icons will be removed, enabling a new attempt to enter the password.

The **'EXIT'** screen key acts to escape, back to the previous screen.

2. The correct password, followed by ↵, will provide entry to the main 'Configuration' menu screen, which shows the present settings of the parameters which can be changed using screen keys on this display:

<h2 style="margin: 0;">Configuration</h2>														
Ser. No. XXXXXX		Rev. XXX												
Options : 1.1 GHz		Normal xtal												
Present Settings:														
Ref frequency	50.000 kHz													
Safety Voltage	100.00 V													
Bus Address	1													
Printer	NONE													
Power-up mode	Manual													
Ext ref in	10 MHz													
Ext ref in	Disabled													
<table border="1" style="width: 100%; border-collapse: collapse;"> <tr> <td style="font-size: x-small;">TODAY'S DATE</td> <td style="font-size: x-small;">TIME</td> <td colspan="3"></td> </tr> <tr> <td style="font-size: x-small;">REF FREQ</td> <td style="font-size: x-small;">VOLTAGE LIMIT</td> <td style="font-size: x-small;">DATE TIME</td> <td style="font-size: x-small;">HEAD CONFIG</td> <td style="text-align: center;">MORE</td> </tr> </table>					TODAY'S DATE	TIME				REF FREQ	VOLTAGE LIMIT	DATE TIME	HEAD CONFIG	MORE
TODAY'S DATE	TIME													
REF FREQ	VOLTAGE LIMIT	DATE TIME	HEAD CONFIG	MORE										

3. In this case we are interested in 'BUS ADDRESS'.

#### 6.4.1.5 Change the Bus Address

1. For access from the 'Present Settings' screen, press the **BUS ADDRESS** screen key on the right. This action will transfer to the 'IEEE 488 ADDRESSES' screen:

<h2 style="margin: 0;">Configuration</h2>														
IEEE 488 ADDRESSES														
9500B address= 22														
2nd address inactive														
Change by direct edit only.														
<table border="1" style="width: 100%; border-collapse: collapse;"> <tr> <td style="font-size: x-small;">TODAY'S DATE</td> <td style="font-size: x-small;">TIME</td> <td colspan="3"></td> </tr> <tr> <td style="text-align: center;">EXIT</td> <td></td> <td></td> <td></td> <td style="text-align: center;">9500B SERIES</td> </tr> </table>					TODAY'S DATE	TIME				EXIT				9500B SERIES
TODAY'S DATE	TIME													
EXIT				9500B SERIES										

The 9500B IEEE-488 bus address can be set to any number within the range 0 to 30.

2. Use Digit edit or Direct edit to set the required bus address number. If using Direct edit, after typing the number press the ↵ key.
3. Press **EXIT** to return to the 'Present Settings' screen.

For second address (5000-series emulation), refer to Section 6, Appendix F.

Final Width = 215mm

Final Width = 215mm

## 6.4.2 Operation via the IEEE-488 Interface

### 6.4.2.1 General

The power-up sequence is performed as in local operation. The 9500B can be programmed to generate an SRQ at power-up, also preparing a status response for transmission to the controller when interrogated by a subsequent serial poll.

### 6.4.2.2 Operating Conditions

When the 9500B is operating under the direction of the application program, there are two main conditions, depending on whether the application program has set the 'REN' management line 'true' or 'false':

#### 1. REN True ('REN' line low):

The 9500B can be addressed and commanded if in either 'Manual' or 'Calibration' mode. All access to front panel control will be removed, except for the bottom right screen key, labelled 'Enable Local Usage'. The cursor controls will not be present.

If *LLO* (Local Lockout) has been sent with REN true, then the 'Enable Local Usage' screen key will be inoperative. If *LLO* has not been sent, the 'Enable Local Usage' screen key will return to local control as if REN were false (see 2 below).

The 9500B will act in response to valid commands, performing any changes in output, etc. The display presentation will track the changes.

Remote control cannot command 'Configuration' mode or 'Procedure' mode. These are Local Modes only. Remote control cannot break into locally-entered 'Configuration' mode, 'Procedure' mode or 'Test' mode. However, 'Test' can be run remotely.

#### 2. REN False ('REN' line high):

The 9500B will remain in Local Operation, but can be addressed and commanded, while full access to front panel control is also retained.

The 9500B will act in response to the commands, performing any changes in output, etc. No visible effect will be observed, other than the display presentation tracking the changes.

### 6.4.2.3 Programmed Transfer to Local Control (GTL or REN False)

The application program can switch the 9500B into 'Local' Control (by sending Command *GTL*, or by setting the *REN* line false), permitting a user to take manual control from the front panel.

The application program can regain 'Remote' control by sending the overriding command: *Listen Address* with *REN* true (addressing the 9500B as a listener with the Remote Enable management line true {Low}). This will reimpose remote control, unless the 9500B is in Configuration, Procedure or Test Mode.

### 6.4.2.4 'Device Clear'

Either of the commands *DCL* or *SDC* will force the following instrument states:

- all IEEE 488 input and output buffers cleared;
- with 'IFC' (Interface Clear), any device-dependent message bus holdoffs cleared.
- the status byte is changed by clearing the MAV bit.

These commands **will not**:

- change any settings or stored data within the device except as listed above;
- interrupt analog output;
- interrupt or affect any functions of the device not associated with the IEEE 488 system;

### 6.4.2.5 Levels of Reset

Three levels of reset are defined for IEEE 488.2 application programs, a complete system reset being accomplished by resetting at all three levels, in order, to every device. In other circumstances they may be used individually or in combination:

**IFC** Bus initialization;

**DCL** Message exchange initialization;

**\*RST** Device initialization.

The effects of the \*RST command are described in *Appendix D* to this section.

### 6.4.3 Message Exchange

#### 6.4.3.1 IEEE 488.2 Model

The IEEE 488.2 Standard document illustrates its Message Exchange Control Interface model at the detail level required by the device designer. Much of the information at this level of interpretation (such as the details of the internal signal paths etc.) is transparent to the application programmer. However, because each of the types of errors flagged in the Event Status Register is related to a particular stage in the process, a simplified 9500B interface model can provide helpful background. This is shown below in Fig. 6.1, together with brief descriptions of the actions of its functional blocks.

#### 6.4.3.2 9500B STATUS Subsystem

**Input/Output Control** transfers messages from the 9500B output queue to the system bus; and conversely from the bus to either the input buffer, or other predetermined destinations within the device interface. It receives the Status Byte from the status reporting system, as well as the state of the Request Service bit which it imposes on bit 6 of the Status Byte response. Bit 6 reflects the 'Request Service state true' condition of the interface.

#### 6.4.3.3 Incoming Commands and Queries

The **Input Buffer** is a first in - first out queue, which has a maximum capacity of 128 bytes (characters).

Each incoming character in the I/O Control generates an interrupt to the instrument processor which places it in the Input Buffer for examination by the Parser. The characters are removed from the buffer and translated with appropriate levels of syntax checking. If the rate of programming is too fast for the Parser or Execution Control, the buffer will progressively fill up. When the buffer is full, the handshake is held.

The **Parser** checks each incoming character and its message context for correct Standard-defined generic syntax, and correct device-defined syntax. Offending syntax is reported as a **Command Error**, by setting true bit 5 (CME) of the Standard-defined Event Status register (refer to Sub-Section 6.5 'Retrieval of Device Status Information').

**Execution Control** receives successfully parsed messages, and assesses whether they can be executed, given the currently-

programmed state of the 9500B functions and facilities. If a message is not viable then an Execution Error is reported, by setting true bit 4 (EXE) of the Standard-defined Event Status register. Viable messages are executed in order, altering the 9500B functions, facilities etc. Execution does not 'overlap' commands; instead, the 9500B Execution Control processes all commands 'sequentially' (ie. waits for actions resulting from the previous command to complete before executing the next).

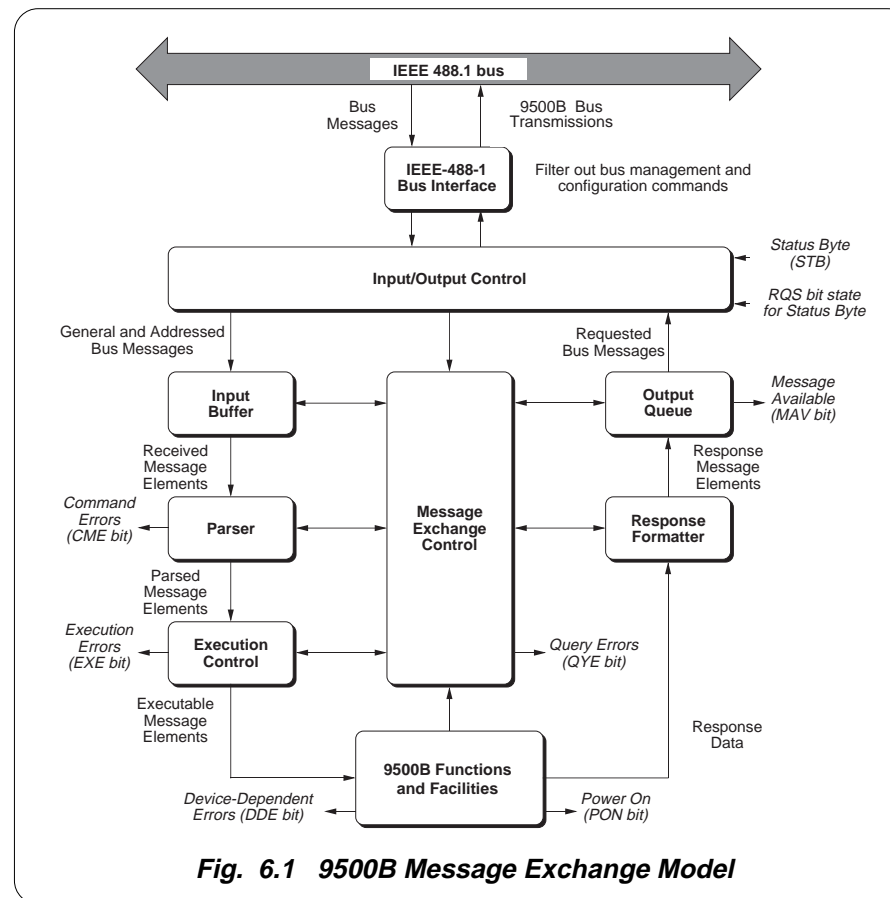

Final Width = 215mm

*Final Width = 215mm*

---

### 6.4.3 Message Exchange *(Contd.)*

#### 6.4.3.4 9500B Functions and Facilities

The 9500B Functions and Facilities block contains all the device-specific functions and features of the 9500B, accepting Executable Message Elements from Execution Control and performing the associated operations. It responds to any of the elements which are valid Query Requests (both IEEE 488.2 Common Query Commands and 9500B Device-specific Commands) by sending any required Response Data to the Response Formatter (after carrying out the assigned internal operations).

**Device-dependent** errors are detected in this block. Bit 3 (DDE) of the Standard Event Status register is set true when an internal operating fault is detected. Each reportable error number is appended to the Error Queue as the error occurs.

#### 6.4.3.5 Outgoing Responses

The **Response Formatter** derives its information from Response Data (being supplied by the Functions and Facilities block) and valid Query Requests. From these it builds Response Message Elements, which are placed as a Response Message into the Output Queue.

The **Output Queue** acts as a store for outgoing messages until they are read over the system bus by the application program. For as long as the output queue holds one or more bytes, it reports the fact by setting true bit 4 (Message Available - MAV) of the Status Byte register. Bit 4 is set false when the output queue is empty (*refer to Sub-Section 6.5 'Retrieval of Device Status Information'*).

#### 6.4.3.6 'Query Error'

This is an indication that the application program is following an inappropriate message exchange protocol, resulting in the *Interrupted, Unterminated or Deadlocked* condition:

Refer to 'Bit 2' in *paras 6.5.3.5*.

The Standard document defines the 9500B's response, part of which is to set *true* bit 2 (QYE) of the Standard-defined Event Status register.

### 6.4.4 Request Service (RQS)

#### 6.4.4.1 Reasons for Requesting Service

There are two main reasons for the application program to request service from the controller:

- When the 9500B message exchange interface is programmed to report a system programming error;
- When the 9500B is programmed to report significant events by RQS.

The significant events vary between types of devices; thus there is a class of events which are known as 'Device-Specific'. These are determined by the device designer.

#### 6.4.4.2 RQS in the IEEE 488.2 Model

The application programmer can enable or disable the event(s) which are required to originate an RQS at particular stages of the application program. The IEEE 488.2 model is extended to incorporate a flexible SCPI status reporting structure in which the requirements of the device designer and application programmer are both met.

This structure is described in *Sub-Section 6.5, dealing with 'Retrieval of Device Status Information'*.



---

## 6.5 Retrieval of Device Status Information

### 6.5.1 General

For any remotely-operated system, the provision of up-to-date information about the performance of the system is of major importance. In the case of systems which operate under automatic control, the controller requires the necessary feedback to enable it to progress the task; any break in the continuity of the process can have serious results.

When developing an application program, the programmer needs to test and revise it, knowing its effects. Confidence that the program elements are couched in the correct grammar and syntax (and that the program commands and queries are thus being accepted and acted upon), helps to reduce the number of iterations needed to confirm and develop the viability of the whole program. So any assistance which can be given in closing the information loop must benefit both program compilation and subsequent use.

Such information is given in the following pages.

### 6.5.2 IEEE-488 and SCPI Standard-Defined Features

(Fig. 6.2 - Overleaf)

Two main categories of information are provided: 'Status Summary' information, and 'Event Register' conditions.

#### 6.5.2.1 Status Summary Information and SRQ

The Status Byte consists of four 'summary' bits which notify events in the 8-bit latched IEEE-488.2-defined 'Event Status Register' (ESB), the two 16-bit latched SCPI-defined registers (OSS & QSS), and the Output Queue (MAV). Whenever one of these summary bits is enabled and set *true*, the Status Byte summary bit (MSS) is also set *true*. The buffered bit 'RQS' follows *true* when MSS goes *true*, and will set the IEEE-488 SRQ line *true* (Note that in Fig 6.2 no arrow points at bit 6 of the Service Request Enable Register — bit 6 is always enabled).

A subsequent serial poll by the Application Program will discover that the 9500B was the requesting device (while resetting RQS *false* again, MSS remaining *true*), and which of the summary bits is *true*. The \*STB? command is an equivalent command to serial poll, where serial poll is not available.

#### 6.5.2.2 Event Register Conditions

The Status Byte summary bits direct the application program down the structure towards causal events.

ESB and MAV are standard IEEE-488 features, described in detail in *Sub-Section 6.5.3*.

OSS and QSS are features of the SCPI structure, described in *Sub-Section 6.5.4*.

#### 6.5.2.3 Access via the Application Program

Referring to Fig. 6.2, take as an example the main Event Status register:

##### Enabling the Events

The main *Standard-Defined Event Status Register* has a second '*Event Status Enable Register*'. A program command (\*ESE *phs Nrf*) can be used to set the state of the bits in the *Enable* register. This enables or disables the events which will set the main register's summary bit *true*.

##### Reading the Enable Register

A 'query' command (\*ESE?) permits the application program to read the state of the *Enable* register, and hence find out which events are enabled to be reported.

##### Reading the Main Register

Another 'query' command (\*ESR?) reads the state of the main *Standard-Defined* register, to discover which event has occurred (i.e. has caused the summary bit to be set *true*). Reading this register clears all its bits.

##### Reporting the Event

If an event is to be reported via the SRQ, its corresponding *enable* bit will have been set *true*, (using the number *Nrf*). Each bit in the *Standard-Defined* register remains in *false* condition unless its assigned event occurs, when its condition changes to *true* and remains *true* until cleared by \*ESR? or \*CLS. This causes the register's summary bit in the Status Byte also to be set *true*. If this bit is enabled, then the Status Byte *bit 6* (MSS/RQS) will be set *true*, and the 9500B will set the IEEE-488 bus SRQ line *true*.

*Final Width = 215mm*

*continued overleaf →*

Final Width = 215mm

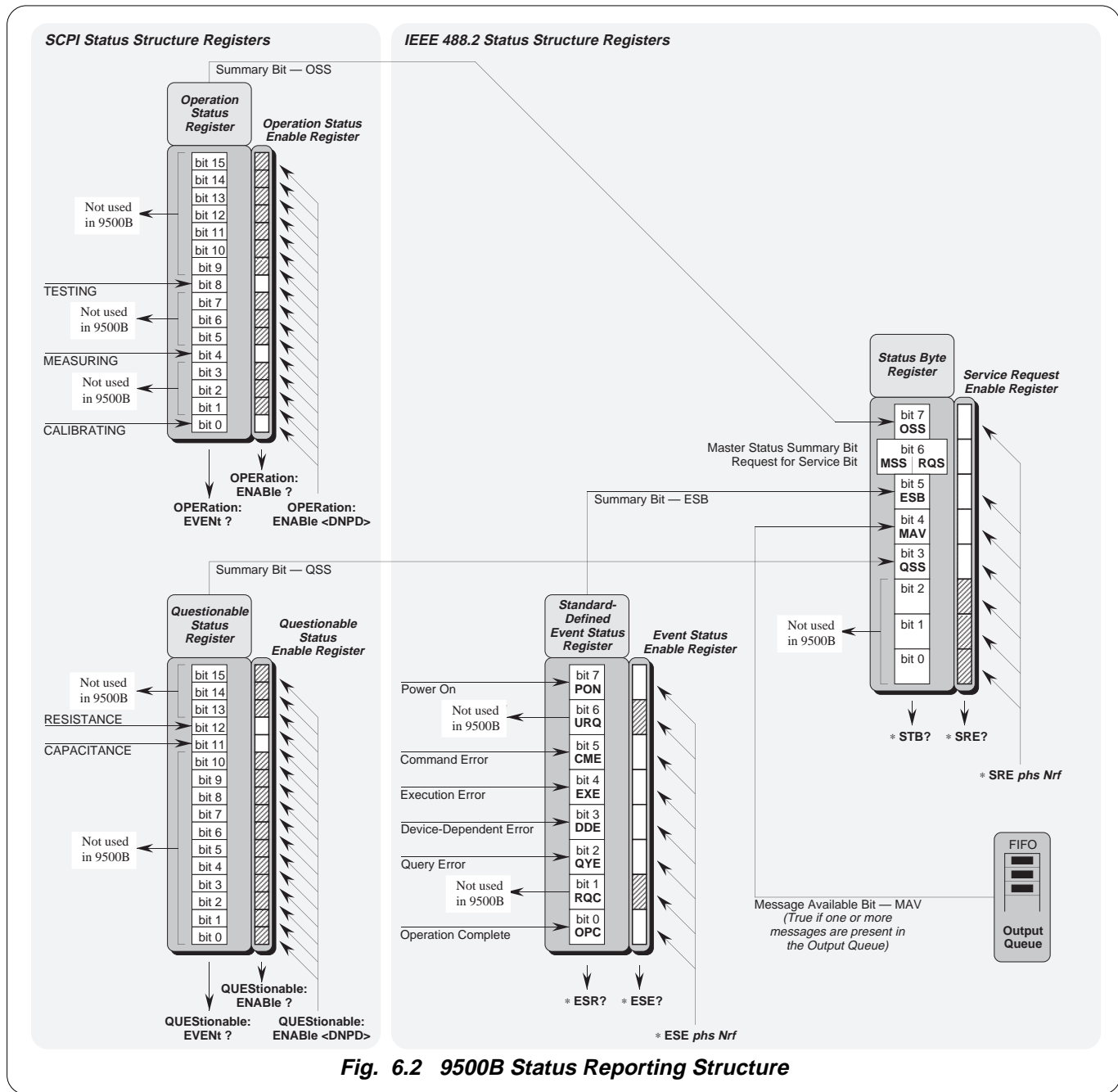

Fig. 6.2 9500B Status Reporting Structure

## 6.5.2 IEEE-488 and SCPI Standard-Defined Features *(Contd.)*

### 6.5.2.3 Access via the Application Program *(Contd.)*

#### SCPI Status Registers

The two SCPI Status registers operate in the same way, using the appropriate program commands to set the enable registers, and query commands to discover the condition of the registers.

#### Subsequent Action

Thus the application programmer can enable any assigned event to cause an SRQ, or not. The controller can be programmed to read the Status Byte, using a serial poll to read the Status Byte register and the *true* summary bit (ESB, OSS, QSS or MAV). The application program then investigates the appropriate event structure until the causal event is discovered. The detail for each register is expanded in the following paragraphs, and in the command descriptions.

## 6.5.3 9500B Status Reporting - IEEE-488.2 Basics

### 6.5.3.1 IEEE 488.2 Model

This develops the IEEE 488.1 model into an extended structure with more definite rules. These rules invoke the use of standard 'Common' messages and provide for device-dependent messages. A feature of the structure is the use of 'Event' registers, each with its own enabling register as shown in *Fig. 6.2*.

### 6.5.3.2 9500B Model Structure

The IEEE 488.2 Standard provides for an extensive hierarchical structure with the Status Byte at the apex, defining its bits 4, 5 and 6 and their use as summaries of a *Standard*-defined event structure, which must be included if the device is to claim conformance with the Standard. The 9500B employs these bits as defined in the Standard.

Bits 0, 1, 2 and 3 and 7 are available to the device designer; only bits 3 and 7 are used in the 9500B, and these are as defined by the SCPI standard.

It must be recognized by the application programmer that whenever the application program reads the Status Byte, it can only receive summaries of types of events, and further query messages will be needed to probe the details relating to the events themselves. For example: a further byte is used to expand on the summary at bit 5 of the Status Byte.

### 6.5.3.3 Status Byte Register

In this structure the Status Byte is held in the 'Status Byte Register'; the bits being allocated as follows:

**Bits:** 0 (DIO1), 1 (DIO2) and 2 (DIO3) are not used in the 9500B status byte. They are always *false*.

**Bit 3** (DIO4) SCPI-defined Questionable Status Summary Bit (QSS)

**Bit 3** summarizes the state of the 'Questionable Status data', held in the 'Questionable Status register' (QSR), whose bits represent SCPI-

defined and device-dependent conditions in the 9500B. The QSS bit is *true* when the data in the QSR contains one or more enabled bits which are *true*; or *false* when all the enabled bits in the byte are *false*. The QSR and its data are defined by the SCPI Standard; they are described in *Sub-Section 6.5.4*.

**Bit 4** (DIO5) IEEE 488.2-defined Message Available Bit (MAV)

The MAV bit helps to synchronize information exchange with the controller. It is *true* when a message is placed in the Output Queue; or *false* when the Output Queue is empty.

The common command \*CLS can clear the Output Queue, and the MAV bit 4 of the Status Byte Register; providing it is sent immediately following a 'Program Message Terminator'.

**Bit 5** (DIO6) IEEE 488.2-defined Standard Event Summary Bit (ESB)

Summarizes the state of the 'Event Status byte', held in the 'Event Status register' (ESR), whose bits represent IEEE 488.2-defined conditions in the device. The ESB bit is *true* when the byte in the ESR contains one or more enabled bits which are *true*; or *false* when all the enabled bits in the byte are *false*.

**Bit 6** (DIO7) is the Master Status Summary Message (MSS bit), and is set *true* if one of the bits 0 to 5 or bit 7 is *true* (bits 0, 1 and 2 are always *false* in the 9500B).

**Bit 7** (DIO4) SCPI-defined Operation Status Summary Bit (QSS)

Summarizes the state of the 'Operation Status data', held in the 'Operation Status register' (OSR), whose bits represent processes in progress in the 9500B. The OSS bit is *true* when the data in the OSR contains one or more enabled bits which are *true*; or *false* when all the enabled bits in the byte are *false*. The OSR is described in *Sub-Section 6.5.4*.

*continued overleaf* →

*Final Width = 215mm*

Final Width = 215mm

### 6.5.3 9500B Status Reporting - IEEE-488.2 Basics (Contd.)

#### Reading the Status Byte Register \*STB?

The common query: \*STB? reads the binary number in the Status Byte register. The response is in the form of a decimal number which is the sum of the binary weighted values in the enabled bits of the register. In the 9500B, the binary-weighted values of bits 0, 1 and 2 are always zero.

#### 6.5.3.4 Service Request Enable Register

The SRE register is a means for the application program to select, by enabling individual Status Byte summary bits, those types of events which are to cause the 9500B to originate an RQS. It contains a user-modifiable image of the Status Byte, whereby each *true* bit acts to enable its corresponding bit in the Status Byte.

#### Bit Selector: \*SRE *phs Nrf*

The common program command: \*SRE *phs Nrf* performs the selection, where *Nrf* is a decimal numeric, whose binary decode is the required bit-pattern in the enabling byte.

For example:

If an RQS is required only when a Standard-defined event occurs and when a message is available in the output queue, then *Nrf* should be set to 48. The binary decode is 00110000 so bit 4 or bit 5, when *true*, will generate an RQS; but with this decode, even if bit 3 is *true*, no RQS will result. The 9500B always sets *false* the Status Byte bits 0, 1 and 2, so they can never originate an RQS whether enabled or not.

#### Reading the Service Request Enable Register

The common query: \*SRE? reads the binary number in the SRE register. The *response* is in the form of a decimal number which is the sum of the binary-weighted values in the register. The binary-weighted values of bits 0, 1 and 2 will always be zero.

#### 6.5.3.5 IEEE 488.2-defined Event Status Register

The 'Event Status Register' holds the Event Status Byte, consisting of event bits, each of which directs attention to particular information. All bits are 'sticky'; ie. once *true*, cannot return to *false* until the register is cleared. This occurs automatically when it is read by the query: \*ESR?. The common command \*CLS clears the Event Status Register and associated error queue, but not the Event Status Enable Register.

**Note** that because the bits are 'sticky', it is necessary to read the appropriate subordinate register of the status structure in order to clear *its* bits and allow a new event from the same source to be reported.

The 'Event Status Register' bits are named in mnemonic form as follows:

#### Bit 0 Operation Complete (OPC)

This bit is *true* only if \*OPC has been programmed *and* all selected pending operations are complete. As the 9500B operates in serial mode, its usefulness is limited to registering the completion of long operations, such as self-test.

#### Bit 1 Request Control (RQC)

This bit is not used in the 9500B. It is always set *false*.

#### Bit 2 Query Error (QYE)

QYE *true* indicates that the application program is following an inappropriate message exchange protocol, resulting in the following situations:

- **Interrupted Condition.** When the 9500B has not finished outputting its **Response Message** to a **Program Query**, and is interrupted by a new **Program Message**.
- **Unterminated Condition.** When the application program attempts to read a **Response Message** from the 9500B without having first sent the complete

**Query Message** (including the **Program Message Terminator**) to the instrument.

- **Deadlocked Condition.** When the input and output buffers are filled, with the parser and the execution control blocked.

#### Bit 3 Device Dependent Error (DDE)

DDE is set *true* when an internal operating fault is detected, and the appropriate error message is added to the Error Queue. See the 'Note about the Error Queue' below.

#### Note about the ERROR Queue

The *Error Queue* is a sequential memory stack. Each reportable error has been given a listed number and explanatory message, which are entered into the error queue as the error occurs. The queue is read destructively as a First-In/First-Out stack, using the query command *SYSTEM ERROR?* to obtain a code number and message.

Repeated use of the query *SYSTEM ERROR?* will read successive Device-Dependent, Command and Execution errors until the queue is empty, when the 'Empty' message (0, "No error") will be returned.

It would be good practice to repeatedly read the *Error Queue* until the 'Empty' message is returned.

The common command \*CLS clears the queue.

#### Bit 4 Execution Error (EXE)

An execution error is generated if the received command cannot be executed, owing to the device state or the command parameter being out of bounds. The appropriate error message is added to the Error Queue.

See the 'Note about the Error Queue' above.

**Bit 5** Command Error (CME)  
CME occurs when a received bus command does not satisfy the IEEE 488.2 generic syntax or the device command syntax programmed into the instrument interface's parser, and so is not recognized as a valid command. The appropriate error message is added to the Error Queue. See the 'Note about the Error Queue' on the previous page.

**Bit 6** User Request (URQ)  
This bit is not used. It is always set *false*.

**Bit 7** 9500B Power Supply On (PON)  
This bit is set *true* only when the Line Power has just been switched on to the 9500B, the subsequent Power-up Selftest has been completed successfully, and the 9500B defaults into Manual mode at Power-on. (If the Power-on default is Procedure mode, remote operation is not available. If the selftest is unsuccessful, the 9500B will report the fact in Test mode, which also does not permit remote operation).

Whether or not an SRQ is generated by setting bit 7 *true*, depends on the previously-programmed 'Power On Status Clear' message *\*PSC phs Nrf*:

- For an *Nrf* of 1, the Event Status Enable register would have been cleared at power on, so PON would not generate the ESB bit in the Status Byte register, and no SRQ would occur at power on.
- If *Nrf* was zero, **and** the Event Status Enabling register bit 7 *true*, **and** the Service Request Enabling register bit 5 *true*; a change from Power Off to Power On will generate an SRQ. This is only possible because the enabling register conditions are held in non-volatile memory, and restored at power on.

This facility is included to allow the application program to set up conditions so that a momentary Power Off followed by reversion to Power On (which could upset the 9500B programming) will be reported by SRQ. To achieve this, the Event Status register bit 7 must be permanently *true* (by *\*ESE phs Nrf*, where  $Nrf \geq 128$ ); the Status Byte Enable register bit 5 must be set permanently *true* (by command *\*SRE phs Nrf*, where *Nrf* lies in one of the ranges 32-63, 96-127, 160-191, or 224-255); Power On Status Clear must be disabled (by *\*PSC phs Nrf*, where  $Nrf = 0$ ); and the Event Status register must be read destructively immediately following the Power On SRQ (by the common query *\*ESR?*).

#### 6.5.3.6 Standard Event Status Enable Register

The ESE register is a means for the application program to select, from the positions of the bits in the standard-defined Event Status Byte, those events which when *true* will set the ESB bit *true* in the Status Byte. It contains a user-modifiable image of the standard Event Status Byte, whereby each *true* bit acts to enable its corresponding bit in the standard Event Status Byte.

##### Bit Selector: *\*ESE phs Nrf*

The program command: *\*ESE phs Nrf* performs the selection, where *Nrf* is a decimal numeric, which when decoded into binary, produces the required bit-pattern in the enabling byte.

For example:

If the ESB bit is required to be set *true* only when an execution or device-dependent error occurs, then *Nrf* should be set to 24. The binary decode is 00011000 so bit 3 or bit 4, when *true*, will set the ESB bit *true*; but when bits 0-2, or 5-7 are *true*, the ESB bit will remain *false*.

#### Reading the Standard Event Enable Register

The common query: *\*ESE?* reads the binary number in the ESE register. The response is a decimal number which is the sum of the binary-weighted values in the register.

#### 6.5.3.7 The Error Queue

As errors in the 9500B are detected, they are placed in a 'first in, first out' queue, called the 'Error Queue'. This queue conforms to the format described in the SCPI Command Reference (Volume 2) Chapter 19, para 19.7, although errors only are detected. Three kinds of errors are reported in the Error Queue, in the sequence that they are detected:

##### Command Errors, Execution Errors and Device-Specific errors

#### Reading the Error Queue

The queue is read destructively as described in the SCPI Command Reference, using the query command *SYSTEM ERROR?* to obtain a code number and error message. The query *SYSTEM ERROR?* can be used to read errors in the queue until it is empty, when the message '0, No Error' will be returned.

*Final Width = 215mm*

*Final Width = 215mm*

---

## 6.5.4 9500B Status Reporting — SCPI Elements

### 6.5.4.1 General

In addition to IEEE 488.2 status reporting the 9500B implements the Operation and Questionable Status registers with associated 'Condition', 'Event' and 'Enable' commands. The extra status deals with current operation of the instrument and the quality of operations.

The structure of these two registers is detailed in *Fig. 6.2*, together with the nature of the reported events. Access to the registers is detailed in the STATUS subsystem of *Sub-Section 6.6* of this handbook.

### 6.5.4.2 SCPI Status Registers

The SCPI states are divided into two groups, reporting from the Operation or Questionable Status event register. Each Status register has its own 'Enable' register, which can be used as a mask to enable bits in the event register itself, in a similar way to that set by the \*ESE command for the Standard Event status Register (ESR).

Each Status Register is associated with its own third 'Condition' register (not illustrated in *Fig. 6.2*), in which the bits are not 'sticky', but are set and reset as the internal conditions change.

Each Enable Register can be commanded to set its mask to enable selected bits in the corresponding Event Register. All registers (Event, Enable and Condition) can be interrogated by appropriate 'Queries' to divulge their bits' states.

### 6.5.4.3 Reportable SCPI States

#### Operation Status Event Register

The following 'sticky' bits are set by their associated conditions:

- bit 0** CALIBRATING: the instrument is performing a VCO characterize, a DAC characterize or a DC/Square characterize.
- bit 4** MEASURING: the instrument is performing a measurement cycle for capacitance or resistance.
- bit 8** TESTING: the instrument is running a self test.

#### Questionable Status Event Register

The following 'sticky' bits are set by their associated conditions:

- bit 11** CAPACITANCE: The measurement of capacitance is questionable.
- bit 12** RESISTANCE: The measurement of resistance is questionable.

---

## 6.6 9500B SCPI Language - Commands and Syntax

*The command subsystems are placed in alphabetical order.*

### 6.6.1 Introduction

This Sub-Section lists and describes the set of SCPI-compatible remote commands used to operate the 9500B.

To provide familiar formatting for users who have previously used the SCPI reference documentation, the command descriptions are dealt with in a similar manner. In particular, each sub-system's documentation starts with a short description, followed by a table showing the complete set of commands in the sub-system; finally the effects of individual keywords and parameters are described. Some extra identification of style and syntax is detailed in *paras 6.6.1.1 and 6.6.1.2* to clarify shorthand meanings.

#### 6.6.1.1 SCPI Syntax and Styles

Where possible the syntax and styles used in this section follow those defined by the SCPI consortium. The commands on the following pages are broken into three columns; the **KEYWORD**, the **PARAMETER FORM**, and any **NOTES**. Notes are signified by an oblique stroke (/) followed by curly brackets {}.

The **KEYWORD** column provides the name of the command. The actual command consists of one or more keywords since SCPI commands are based on a hierarchical structure, also known as the tree system.

Square brackets ( [ ] ) are used to enclose a **keyword** that is optional when programming the command; that is, the 9500B will process the command to have the same effect whether the optional node is omitted by the programmer or not.

Letter case in tables is used to differentiate between the accepted shortform (upper case) and the long form (upper and lower case).

The **PARAMETER FORM** column indicates the number and order of parameter in a command and their legal value. Parameter types are distinguished by enclosing the type in angle brackets ( < > ). If **parameter** form is enclosed by square brackets ( [ ] ) these are then optional (care must be taken to ensure that optional parameters are consistent with the intention of the associated keywords). The vertical bar ( | ) can be read as "or" and is used to separate alternative parameter options.

#### 6.6.1.2 Legend

- <dnpd> = Decimal Numeric Program Data, used to identify numerical information needed to set controls to required values. The numbers should be in 'Nrf' form as described in the IEEE 488.2 Standard Specification.
  
- <cpd> = Character Program Data. This normally represents alternative groups of unique 'literate' parameter names, available for the same keyword. In the notation the set of alternatives will follow the <cpd> in the Parameter Form column of the Sub-System table, enclosed in a pair of braces. For example, in the OUTPut sub-system, the compound command header (keyword): OUTPut [ : STATE ] is followed by the parameter form <cpd> { ON | OFF | 1 | 0 }. The <cpd> gives the denomination of 'Character' program data, and { ON | OFF | 1 | 0 } gives the actual characters to be used to command each unique parameter.
  
- <spd> = String Program Data. This is a string of variable literate characters which will be recognized by the internal 9500B software. They are used for such inputs as passwords and date/time.
  
- ? = Indicate query commands with no associated command form, and no attached parameters.  
(for example: CALibration:TRIGger?).
  
- (?) = All commands which may include parameters in the command form, but also have an additional query form without parameters.  
(for example: ROUTe:SIGNal:[PATH](?)  
<cpd> { CH1 | CH2 | CH3 | CH4 | CH5 }  
The response from this query will be one of the parameters listed in association with the command.

*Final Width = 215mm*

Final Width = 215mm

## 6.6.2 CALibration Subsystem

This subsystem is used to calibrate the functions and hardware ranges of the 9500B. This will correct for any system errors due to drift or ageing effects.

Before any calibration can take place, two security levels must be set. First, there is a switch on the 9500B itself that must be set to CAL ENABLE. Having done this, the calibration password command must be sent.

Once entered into Calibration mode, the commands present in the table at 6.6.2.1 are enabled.

### 6.6.2.1 CALibration Subsystem Table

Keyword	Parameter Form
CALibration	
:SECure	
:PASSword	<spd>
:EXIT	[ <spd> , <cpd> { PRD7   PRD14   PRD30   PRD60 } ]
:TARGet	<dnpd> , <dnpd> [ , <dnpd> ]
:TRIGger?	
:HEAD	
:EHFSine	<cpd> { LINearity   FLATness }
:VHFSine	<cpd> { LINearity   FLATness }
:HFSine	<cpd> { LINearity   FLATness }
:LFSine	
:E70	<cpd> { LINearity   GAIN   SPEed }
:E150	<cpd> { LINearity   GAIN   SPEed }
:E500	<cpd> { LINearity   GAIN   SPEed }
:MARKer	<cpd> { SINusoid }
:CAPacitance	
:RESistance	
:STORe?	<spd> , <cpd> { PRD7   PRD14   PRD30   PRD60 }
:BASE	
:SFRequency	<dnpd>
:SPECial	
:DAC?	
:VCO?	
:DCSQ?	
:TMK?	
:LFSine?	
:FADJust	
:FADJust?	<dnpd>
:PWD?	

### 6.6.2.2 CAL:SEC:PASS <spd>

#### Purpose

This command is used to gain access to Calibration mode. The <spd> must be the correct 'Calibration' password registered in the 9500B software. The calibration password can be changed only in Configuration mode from the 9500B front panel (*Refer to Section 3*).

### 6.6.2.3 CAL:SEC:EXIT [ <spd> , <cpd> { PRD7 | PRD14 | PRD30 | PRD60 } ]

#### Purpose

This command is used to switch off Calibration mode, cancelling any set CAL:TARG command and protecting the calibration by disabling the calibration commands. Parameters in the command permit a user optionally to date-stamp the calibration, record and set up an advance warning for the next-due calibration date. Certain Functions are not available in Calibration Mode, for which calibration is not required. When finishing a calibration procedure, it is necessary to exit from Calibration mode in order to access these functions.

- The <spd> must be the due date of the next calibration for the 9500B. It must conform to the format decided by the SYStem FORmat <spd> command.
- The <cpd>, PRDXX gives the required number of days advance warning of the cal due date.  
(*Refer to 9500B Verification and Adjustment Handbook, Section 10*).

### 6.6.2.4 CAL:TARG <dnpd> , <dnpd> [ , <dnpd> ]

#### Purpose

For each calibration operation, the required calibration point (factor) must be targetted (*Refer to Section 10, Paras 10.3.4*). This command permits the user to define three parameters associated with the calibration point in the current operation:

- The first <dnpd> is an integer from 1 to 6, allocated to the calibration point at which calibration is intended. This will be one of those listed on the Calibration mode screen, in 'Target State', for the corresponding function and hardware range.
- The second <dnpd> is a value which will determine the required *hardware range (amplitude)* of the 9500B for that calibration point.
- The third, optional, <dnpd> is a value which will determine the required *hardware range (frequency)* of the 9500B for that calibration point.



---

Once a target has been set, the 9500B adjustment is restricted to values within the selected hardware voltage span and frequency band. In order to release this restriction, one of the following commands must be sent:

TRIG? , EXIT or a new TARG command

Any error which occurs will also release the restriction.

#### **6.6.2.5 CAL:TRIG?**

##### **Purpose**

After the parameters are set for calibration at a single calibration point, this command initiates the internal calibration process. This command applies to the TARG settings.

##### **Response**

Operation is successful: returns a '0'. Operation fails for any reason: returns a '1' and an error message is put in the error queue.

#### **6.6.2.6 CAL:SPEC:DAC?**

##### **Purpose**

This command characterizes the instrument's main digital-to-analogue converter (DAC). The process takes several minutes to complete.

##### **Response**

Operation is successful: returns a '0'.  
Operation fails for any reason: returns a '1' and an error message is put in the error queue.

#### **6.6.2.7 CAL:SPEC:VCO?**

##### **Purpose**

This command characterizes the instrument's Voltage-controlled Oscillator (VCO).

##### **Response**

Operation is successful: returns a '0'.  
Operation fails for any reason: returns a '1' and an error message is put in the error queue.

#### **6.6.2.8 CAL:SPEC:DCSQ?**

##### **Purpose**

This command performs calculations to derive the Square function calibration constants from the DC calibration constants.

##### **Response**

Operation is successful: returns a '0'.  
Operation fails for any reason: returns a '1' and an error message is put in the error queue.

#### **6.6.2.9 CAL:SPEC:FADJust**

##### **Purpose**

This command selects the adjustment facility to allow the frequency generation of the instrument to be calibrated.

#### **6.6.2.10 CAL:SPEC:FADJust? <dnpd>**

##### **Purpose**

This command supplies the <dnpd> value that is to be written to the frequency correction DAC.

##### **Response**

Operation is successful: returns a '0'.  
Operation fails for any reason: returns a '1' and an error message is put in the error queue.

#### **6.6.2.11 CAL:SPEC:TMK?**

##### **Purpose**

This command characterizes the LF timing marker amplitude. The process takes several minutes.

##### **Response**

Operation is successful: returns a '0'.  
Operation fails for any reason: returns a '1' and an error message is saved in the error queue.

#### **6.6.2.12 CAL:SPEC:LFS?**

##### **Purpose**

This command adjusts to zero the DC offset for LF sine.

##### **Response**

Operation is successful: returns a '0'.  
Operation fails for any reason: returns a '1' and an error message is saved in the error queue.

#### **6.6.2.13 CAL:SPEC:PWD?**

##### **Purpose**

This command characterizes the width of the pulse.

##### **Response**

Operation is successful: returns a '0'.  
Operation fails for any reason: returns a '1' and an error message is saved in the error queue.

*Final Width = 215mm*

*Final Width = 215mm*

**6.6.2.14** CAL:HEAD:EHFS <cpd>{LIN|FLAT}

**Purpose**

This command provides the setup conditions specified in step 1 of the calibration sequence, as detailed in section 10.6.2 of this manual.

**6.6.2.15** CAL:HEAD:VHFS <cpd>{LIN|FLAT}

**Purpose**

This command provides the setup conditions specified in step 1 of the calibration sequence, as detailed in section 10.6.2 of this manual.

**6.6.2.16** CAL:HEAD:HFS <cpd>{LIN|FLAT}

**Purpose**

This command provides the setup conditions specified in step 1 of the calibration sequence, as detailed in section 10.6.2 of this manual.

**6.6.2.16** CAL:HEAD:LFS

**Purpose**

This command provides the setup conditions specified in step 1 of the calibration sequence, as detailed in section 10.6.1 of this manual.

**6.6.2.17** CAL:HEAD:E70 <cpd>{LIN|GAIN|SPE}

**Purpose**

This command provides the setup conditions specified in step 4 of the calibration sequence, as detailed in section 10.6.3 of this manual.

**6.6.2.18** CAL:HEAD:E150 <cpd>{LIN|GAIN|SPE}

**Purpose**

This command provides the setup conditions specified in step 4 of the calibration sequence, as detailed in section 10.6.3 of this manual.

**6.6.2.19** CAL:HEAD:E500 <cpd>{LIN|GAIN|SPE}

**Purpose**

This command provides the setup conditions specified in step 4 of the calibration sequence, as detailed in section 10.6.3 of this manual.

**6.6.2.20** CAL:HEAD:MARK <cpd>{ SIN }

**Purpose**

This command provides the setup conditions specified in step 2 of the calibration sequence, as detailed in section 10.6.4 of this manual.

**6.6.2.21** CAL:HEAD:CAP

**Purpose**

This command provides the setup conditions specified in step 2 of the calibration sequence, as detailed in section 10.6.5 of this manual.

**6.6.2.22** CAL:HEAD:RES

**Purpose**

This command provides the setup conditions specified in step 2 of the calibration sequence, as detailed in section 10.6.6 of this manual.

**6.6.2.23** CAL:HEAD:STOR? <spd>, <cpd>{PRD7|PRD14|PRD30|PRD60}

**Purpose**

This command provides the store for the calibration data as detailed in section 10.6.7 of this manual

**Response**

Operation is successful: returns a '0'

Operation fails for any reason: returns a '1' and an error message is saved in the error queue.

**6.6.3** OUTPut Subsystem

This subsystem is used to configure the output connections of the 9500B and switch the output on and off.

**6.6.3.1** OUTPut Subsystem Table

**Keyword**                      **Parameter Form**

OUTPut  
[:STATe](?)                      <cpd>{ON|OFF|1|0}

**6.6.3.2** OUTP[:STAT](?) <cpd>{ON|OFF|1|0}

**Purpose**

This command turns the 9500B output on and off, and connects both the output signal and trigger signal to the selected output channels.

The head connection will only be validated when the output is turned on. An error will be generated at this point if the head is not connected to the selected 9500B channel.

If a head is removed when the output is on, then if SRQs are enabled, an 'ON' SRQ will be generated.

- ON or 1 will set the output on
- OFF or 0 will set the output off

**Response to Query Version**

The 9500B will return ON if output is on, or OFF if output is off.

## 6.6.4 ROUTe Subsystem

This subsystem is used to configure the output channels to be used for signal and trigger outputs.

### 6.6.4.1 ROUTe Subsystem Table

Keyword	Parameter Form
ROUTE	
:FITTeD(?)	<cpd>{CH1 CH2 CH3 CH4 CH5}
:SIGNal	
[ :PATH](?)	<cpd>{CH1 CH2 CH3 CH4 CH5}
:IMPedance(?)	<dnpd>
:SKEW(?)	<cpd>{CH1 CH2 CH3 CH4 CH5}, {ON OFF 1 0}
:DUAL(?)	<cpd>{CH1 CH2 CH3 CH4 CH5}, {CH1 CH2 CH3 CH4 CH5}
:MCHannel(?)	<cpd>{CH1 CH2 CH3 CH4 CH5}, {ON OFF    }
:TRIGger	
[ :PATH](?)	<cpd>{CH1 CH2 CH3 CH4 CH5 NONE} [, <cpd>{ACTive CABle}]
:IMPedance(?)	<dnpd>
:RATio(?)	<dnpd>

### 6.6.4.2 ROUT:FITT? <cpd>{CH1|CH2|CH3|CH4|CH5}

#### Purpose

This query command returns the *type*, *serial number*, *date last calibrated* and *calibration due date* of the active head fitted to the <cpd> channel.

#### Response Format

The response will be an <Arbitrary ASCII Response Data> element, consisting of four comma-separated fields:

- Field 1 Type (e.g. 9510|9530|CABL|NONE).
- Field 2 Serial Number up to 13 characters.
- Field 3 Date that the head was last calibrated, in the currently-defined date format.
- Field 4 Date that the calibration of the head is due, in the currently-defined date format.

For example, for a channel with an active head fitted:

```
'9510,12345,1997/02/28,1998/02/27'
```

If there is no active head fitted to the <cpd> channel, the response will be:

```
'NONE,0,0000/0/00,0000/0/00'
```

The 9500B can only determine that a cable has been fitted if this was informed via the ROUT:TRIG[:PATH](?) command (*para* 6.6.4.5).

### 6.6.4.3 ROUT:SIGN[:PATH](?) <cpd>{CH1|CH2|CH3|CH4|CH5}

#### Purpose

This command is used to define which channel is associated with the signal output.

The <cpd> does not turn the output on, only selects the signal channel to be used. If the output is on and the channel is to be changed, then the output will be turned off, the new channel will be selected and the output will be turned back on again.

A settings conflict will be generated if a signal channel is selected that is already in use, and an error message will be generated.

#### Response to Query Version

The 9500B will return the name of the selected signal channel.

### 6.6.4.4 ROUT:SIGN:IMP(?) <dnpd>

#### Purpose

This command chooses between the 50Ω or 1MΩ scope impedance matching levels for the selected signal channel.

The value of <dnpd> is rounded to select the required impedance: values ≤55 select 50Ω; values >55 select 1MΩ.

#### Response to Query Version

The 9500B will return 50 if 50Ω is selected, or 1E6 if 1MΩ is selected.

### 6.6.4.5 ROUT:SIGN:SKEW(?) <cpd>{CH1|CH2|CH3|CH4|CH5},{ON|OFF|1|0}

#### Purpose

Use this command to choose a single channel, then use the {ON|OFF|1|0} element to turn the channel ON or Off. Repeat for each channel. Note that at least two channels must be selected for signals to be generated.

A settings conflict error will be reported if the SKEW function has not been selected.

Other ROUTe:SIGNal commands and ROUTe:TRIGger commands are not valid in Zero Skew function.

#### Response to Query Version

The 9500B will return all of the selected channels.

*Final Width = 215mm*

*Final Width = 215mm*

**6.6.4.6 ROUT:SIGN:DUAL(?)**  
**<cpd>{CH1|CH2|CH3|CH4|CH5},**  
**<cpd>{CH1|CH2|CH3|CH4|CH5}**

**Purpose**

This command is for use within the Sine function to output the signal selection on two active heads at the same time. Note that two channels must be selected for signals to be generated. In the parameter list above, the first <cpd> selects the Master signal, the second <cpd> selects the Slave signal.

A settings conflict error will be reported if the 'SINusoid' function shape has not been selected.

This dual mode is cancelled on receipt of a ROUTe:SIGNal <cpd> command or on selection of another function.

Both signals must have the same expected impedance. It is not possible to set their impedances independently.

**Response to Query Version**

The 9500B will return the two selected channels, in the same order.

**6.6.4.7 ROUT:TRIG[:PATH](?) <cpd>{CH1|CH2|CH3|**  
**CH4|CH5|NONE}[,<cpd>{ACT|CABL}]**

**Purpose**

This command defines the channel associated with trigger output.

The ROUT:TRIG command also has the ability to select no trigger output at all, using the NONE parameter.

The <cpd> does not turn the output on, only selects the trigger channel to be used. If the output is on and the channel is to be changed, then the output will be turned off, the new channel will be selected and the output will be turned back on again.

A settings conflict error will be generated if a trigger channel is selected that is already in use, has a cable plugged in, or is not connected. An error message will be generated.

The optional <cpd> also determines which channels will use an active head to deliver the trigger signal, and not a plain cable (with no head inserted). If the ACTive|CABLe <cpd> is not present then the selected channel type will not change.

If an active head is inserted into a channel that has been designated a CABLE, then the output will be turned off and the CABLE selection will be overridden by the ACTive setting.

**Response to Query Version**

The 9500B will return the name of the selected trigger channel.

**6.6.4.8 ROUT:TRIG:IMP(?) <dnpd>**

**Purpose**

This command chooses between the 50Ω or 1MΩ scope impedance matching levels for the selected trigger channel.

The value of <dnpd> is rounded to select the required impedance: values ≤55 select 50Ω; values >55 select 1MΩ.

Attempting to set the trigger channel impedance when the trigger has been set to 'CABLE' will cause a 'settings conflict' error.

Commands setting the trigger channel impedance, when the trigger has been set to 'NONE', will be ignored.

**Response to Query Version**

The 9500B will return 50 if 50Ω is selected, or 1E6 if 1MΩ is selected.

**6.6.4.9 ROUT:TRIG:RAT(?) <dnpd>**

**Purpose**

This command sets the trigger frequency as a ratio of the selected function.

There are three distinct values, divide by 1, divide by 10, divide by 100. The <dnpd> will be rounded in the ranges:

0.9 < dnpd < 1.1	selects 1:1 ratio
9.0 < dnpd < 11.0	selects 1:10 ratio
90.0 < dnpd < 110.0	selects 1:100 ratio

Values outside these ranges will generate a settings "Data out of range" error.

**Response to Query Version**

The 9500B response returns the selected ratio as follows:

if 1:1 is selected	9500B returns 1;
if 1:10 is selected	9500B returns 10;
if 1:100 is selected	9500B returns 1E2.

**6.6.4.10 ROUT:SIGN:MCH**  
**<cpd>{CH1|CH2|CH3|CH4|CH5},{OFF|ON|0|1}**

**Purpose**

This command provides the capability to select multiple channels for the simultaneous output of a DCV signal only. Any changes to the amplitude of this DCV signal will appear on all selected output channels.

## 6.6.5 SOURCE Subsystem

This subsystem is used to select the sources of 9500B output .

### Note about backward compatibility with programs written for the Model 9100 plus Option 250:

For users upgrading to Model 9500B who already have SCPI programs written for Model 9100, a number of 9100 commands have been included in the 9500B command set. These 'SCOPE' commands can be used to make the 9500B select functions and parameters corresponding to those of the 9100.

Where 'SCOPE' commands are available, the keywords and parameters are shown as an alternative to the basic 9500B commands.

### 6.6.5.1 SOURCE Subsystem Table

#### Note to the [SOURCE] Subsystem Table

Many optional keywords are included in the table; shown in square brackets, as required by the SCPI reference document. The structure of the command set is such that in all cases, these optional keywords can be omitted.

#### Notes about Types of Command Separators

The [SOURCE] subsystem has a complex tree structure. To clarify descriptions, examples of branching are referred to the root, so that rather than using the valid short-cut ; branching separator, it is shown as returning to the root by a ; : separator.

This does not mean that valid short-cut 'program message unit' separators cannot be used, but merely that we are defining the commands in full, to avoid confusion.

#### The following commands are for 9100 compatibility

(They are *not* included in the main SOURCE table, but *do* appear in the command descriptions):

Keyword	Parameter Form
[SOURCE] :SCOPE	
[SHAPE](?)	<cpd>{DC SQUare EDGE MARKer SINusoid}
:UUT_Z(?)	<dnpd>
:TRANSition(?)	<cpd>{(RISing FALLing)}

[SOURCE] :SPERiod{CW FIXed}(?)	<dnpd>
-----------------------------------	--------

### 6.6.5.1 SOURCE Subsystem Table (Contd.)

The following are standard 9500B commands:

Keyword	Parameter Form
[SOURCE] :FUNCTION [SHAPE](?)	<cpd>{DC SQUare EDGE MARKer SINusoid  OPULse TELevision LEAKage  RAMP SKEW EXTErnal PWIDth}
:PARAMeter	
:DC	
:GROund(?)	<cpd>{ON OFF 1 0}
:MCHandel(?)	<cpd>{ON OFF 1 0}
:SQUare	
:POLarity(?)	<cpd>{POSitive NEGative SYMMetrical}
:GROund(?)	<cpd>{ON OFF 1 0}
:EDGE	
:TRANSition(?)	<cpd>{(RISing FALLing)}
:SPeed(?)	<dnpd>
:MARKer	
:WAVEform(?)	<cpd>{SQUare PULSe TRIangle LINE}
:HIGHlight(?)	<cpd>{ON OFF 1 0}
:OPULse	
:AMPLitude(?)	<dnpd>
:ENERgy(?)	<dnpd>
:POWer?	
:DUration?	
:EXECute	
:TRIGger(?)	<cpd>{SINGle CONTInuous}
:RAMP	
:TIME(?)	<dnpd>
:TRIGger(?)	<cpd>{START MIDDLE}
:SKEW	
:ALIGNment(?)	<cpd>{DEFAult PRECision}
:TELevision	
:LINE(?)	<dnpd>
:SYNC(?)	<cpd>{COMPosite FRAME}
:LEVel(?)	<cpd>{BLACK GREY WHITE}
:POLarity(?)	<cpd>{POSitive NEGative}
:LEAKage	
:STATe(?)	<cpd>{OPEN CLOSE}
:TRIGger(?)	<cpd>{SINGle CONTInuous}
:EXTErnal	
:VOLTage	
[LEVel]	
[IMMediate]	
[AMPLitude](?)	<dnpd>
:CURRent	
[LEVel]	
[IMMediate]	
[AMPLitude](?)	<dnpd>
:FREQuency	
[CW FIXed](?)	<dnpd>
:PERiod	
[CW FIXed](?)	<dnpd>
:WIDth	
[CW FIXed](?)	<dnpd>

Final Width = 215mm

Final Width = 215mm

## 6.6.5 SOURCE Subsystem (Contd.)

6.6.5.2 [SOUR]:FUNC[:SHAP](?) <cpd>{DC|SQU|EDGE|MARK|SIN|  
OPUL|TEL|LEAK|RAMP|  
SKEW|EXT|PWID}

(9100 Option 250 compatible)

[SOUR]:SCOPE[:SHAP](?) <cpd>{DC|SQU|EDGE|MARK|SIN}

### Purpose

This defines the main signal required output. i.e. selects the source function of the 9500B.

### <cpd>

The 'character program data' determines the waveshape of the output signal. It can be chosen from ten alternatives:

<b>DC</b>	Determines that subsequent selection of VOLT or CURR will have a DC component only.
<b>SQUare</b>	Determines that subsequent selection of VOLT or CURR will have a square waveshape.
<b>EDGE</b>	Selects the edge function. The waveshape is selected with a separate command.
<b>MARKer</b>	Selects the timing marker waveshape.
<b>SINusoid</b>	Selects the levelled sinusoidal waveshape.
<b>OPULSe</b>	Selects the energy pulse used to test the overload detection of scopes.
<b>TELevision</b>	Selects the TV waveform video test signals.
<b>LEAKage</b>	Selects the open and closed head conditions used to determine the UUT's leakage current.
<b>RAMP</b>	Selects the Ramp Function.
<b>SKEW</b>	Selects the Zero Skew Function.
<b>PWIDth</b>	Selects the Pulse Width Function.
<b>EXTernal</b>	Selects the Auxiliary Input signal.

The [SOURce]:SCOPE[:SHAPe] command is for backward compatibility with Option 250 in the 9100. Note that there are some amplitude/frequency selections that were available on the 9100, but are not covered on the 9500B.

The query form of this command returns the short-form version of the command. If none of the above are currently selected (i.e. instrument is in measurement mode) then the word 'NONE' will be returned.

6.6.5.3 [SOUR]:PAR:DC:GRO(?) <cpd>{ON|OFF|1|0}

### Purpose

This command sets the output of the DCV signal to zero (0V) when selected 'ON' and will return the output to its previous value when selected 'OFF'. Changing function will turn off the ground selection.

With output 'ON', a settings conflict error will be reported if the DC function has not been selected.

### <cpd>

The 'character program data' <cpd>ON or <cpd>1 sets the output voltage to ground 0V. Conversely, <cpd>OFF or <cpd>0 returns the output to its previous value.

### Response to Query Version

The instrument will return ON (grounded) or OFF (not grounded) as programmed.

6.6.5.4 [SOUR]:PAR:DC:MCH(?) <cpd>ON|OFF|1|0}

### Purpose

This command enables the input of the DC signal to multiple channels when the selection is 'ON' and disables the multichannels selected when the selection is OFF (see section ROUT:SIGN:MCH).

### Response to Query Version

The instrument will return ON or OFF as programmed.

6.6.5.5 [SOUR]:PAR:SQU:POL(?) <cpd>{POS|NEG|SYMM}

### Purpose

This command selects the polarity of the square wave: above, below, or symmetrical about zero volts.

A settings conflict error will be reported if the SQUare function has not been selected.

### <cpd>

The 'character program data' <cpd>POS sets the output square wave in a positive direction, referred to ground. Similarly, <cpd>NEG sets the output square wave in a negative direction referred to ground, and <cpd>SYMM sets the output square wave symmetrically about ground.

### Response to Query Version

The instrument will return POS, NEG or SYMM as programmed.

---

#### 6.6.5.6 [SOUR]:PAR:SQU:GRO(?) <cpd>{ON|OFF|1|0}

##### **Purpose**

This command sets the square wave output of the signal to zero (0V) when selected 'ON' and will return the output to its previous value when selected 'OFF'. Changing function will turn off the ground selection.

With output 'ON', a settings conflict error will be reported if the SQUARE function has not been selected.

##### **<cpd>**

The 'character program data' <cpd>ON or <cpd>1 sets the output voltage to 0V. Conversely, <cpd>OFF or <cpd>0 returns the output to its previous value.

##### **Response to Query Version**

The instrument will return ON (grounded) or OFF (not grounded) as programmed.

#### 6.6.5.7 [SOUR]:PAR:EDGE:TRAN(?) <cpd>{RISing|FALLing} [SOUR]:SCOP:TRAN(?) <cpd>{RISing|FALLing}

##### **Purpose**

This command applies only to the Edge function. It selects the direction of the edge which follows the trigger.

A settings conflict error will be reported if the EDGE function has not been selected.

##### **<cpd>**

<cpd> RIS sets a positive-going edge, <cpd> FALL sets a negative-going edge.

For details of local operation and parameter limitations, refer to *Section 4, Sub-Section 4.7* (Edge Function).

##### **Response to Query Version**

The instrument will return the present edge setting: RIS or FALL.

#### 6.6.5.8 [SOUR]:PAR:EDGE:SPE(?) <dnpd>

##### **Purpose**

This command selects the speed (slew rate) of the Edge function.

A settings conflict error will be reported if the EDGE function has not been selected.

##### **<dnpd>**

The <dnpd> is rounded so that:

$\text{dnpd} \geq 600\text{E}-12$	selects 100ns edge (HV Edge).
$200\text{E}-12 < \text{dnpd} < 600\text{E}-12$	selects 500ps edge.
$\text{dnpd} \leq 200\text{E}-12$	selects 150ps edge.

For details of local operation and parameter limitations, refer to *Section 4, Sub-Section 4.7* (Edge Function).

##### **Response to Query Version**

The instrument will return the present edge speed setting.

#### 6.6.5.9 [SOUR]:PAR:MARK:WAV(?) <cpd>{SQU|PULS|TRI|LINE}

##### **Purpose**

This command selects the waveshape of the timing marker function.

A settings conflict error will be reported if the MARKER function has not been selected.

Note that period/frequency restrictions are placed on the waveshape selection. An 'Settings Conflict' error will be reported when outside limits.

<cpd> 'character program data' selects waveforms as follows:

<cpd>SQU	: square/sine waveform,
<cpd>PULS	: pulse waveform,
<cpd>TRI	: narrow triangular waveform,
<cpd>LINE	: square waveform at line frequency.

For details of local operation and parameter limitations, refer earlier to *Section 4, Sub-Section 4.8* (Time Marker Function).

##### **Response to Query Version**

The instrument returns the <cpd> for the presently-selected waveform.

*Final Width = 215mm*

Final Width = 215mm

---

## 6.6.5 SOURCE Subsystem (Contd.)

6.6.5.10 [SOUR]:PAR:MARK:HIGH(?) <cpd>{ON|OFF|1|0}

### Purpose

This selects whether the current edge wave shape has every 10th peak 'highlighted', by increasing the peak's amplitude.

A settings conflict error will be reported if LINE marker waveshape is selected.

### <cpd>

The 'character program data' <cpd>ON or <cpd>1 turns the highlighted waveform ON. Conversely, <cpd>OFF or <cpd>0 removes the highlight from the waveform.

For details of local operation and parameter limitations, refer earlier to *Section 4, Sub-Section 4.8* (Time Marker Function).

### Response to Query Version

The instrument will return ON (highlighted) or OFF (not highlighted) as programmed.

6.6.5.11 [SOUR]:PAR:OPUL:AMPL(?) <dnpd>  
[SOUR]:PAR:OPUL:ENER(?) <dnpd>

### Purpose

These commands are used together to set the parameters of the overload test. The combination of amplitude and energy set the power contained within the pulse that will be applied to the unit under test. The amplitude <dnpd> must be signed '-' for negative pulse direction. These commands do not apply the pulse, just select the parameters.

Pulse power and pulse duration are internally calculated from these two commands of amplitude and energy.

A settings conflict error will be reported if the OPULse function has not been selected.

### <dnpd>

The Amplitude <dnpd> has units of Volts, and is restricted to:

$$5 \leq \text{dnpd} \leq 20 \text{ or } -20 \leq \text{dnpd} \leq -5.$$

The Energy <dnpd> has units of Joules, and is restricted so that:

$$1.6 \leq \text{dnpd} \leq 50.$$

For details of local operation and parameter limitations, refer to *Section 4, Sub-Section 4.13* (Overload Pulse Function).

### Response to Query Version

The instrument will return the <dnpd> for the present amplitude or energy.

6.6.5.12 [SOUR]:PAR:OPUL:EXEC

### Purpose

This command will cause the 9500B to apply the overload pulse.

A settings conflict error will be reported if the OPULse function has not been selected or if Output is not already ON.

The EXECute command is not buffered in the 9500B. It will be ignored and discarded if a current EXECute command is not completed

6.6.5.13 [SOUR]:PAR:OPUL:POWER?  
[SOUR]:PAR:OPUL:DURATION?

### Purpose

These two query commands can be used to find out the Power and Duration settings which have been selected by the Amplitude/Energy combination.

A value of 200E33 will be reported if the OPULse function has not been selected.

6.6.5.14 [SOUR]:PAR:OPUL:TRIG(?) <cpd>{SING|CONT}

### Purpose

These command selects the type of UUT triggers associated with the overload function.

Triggers are only produced if the output is on.

A settings conflict error will be reported if the OPULse function has not been selected.

### <cpd>

SINGLE : Generates one trigger coincident with the start of the overload pulse.

CONTinuous : Selects a free running (100 Hz) trigger signal.

For details of local operation and parameter limitations, refer to *Section 4, Sub-Section 4.13* (Overload Pulse Function).

### Response to Query Version

The instrument will return the <cpd> for the currently-selected trigger type.



#### 6.6.5.14 [SOUR]:PAR:RAMP:TIME(?) <dnpd>

##### Purpose

This command selects the rise time of the ramp. Note that it does not set the frequency of the signal (this is three times the ramp time).

A settings conflict will be reported if the RAMP function has not been selected.

##### <dnpd>

1ms to 1s : is rounded to the nearest decade point.

For details of local operation and parameter limitations, refer to *Section 4, Sub-Section 4.12* (Linear Ramp Function).

##### Response to Query Version

The instrument will return the rounded <dnpd>.

#### 6.6.5.15 [SOUR]:PAR:RAMP:TRIG(?) <cpd>{START|MIDDLE}

##### Purpose

This command selects the type of triggers associated with the Ramp function.

Triggers are produced only when the Output is ON.

A settings conflict will be reported if the RAMP function has not been selected.

##### <cpd>

START : generates one trigger coincident with the start of the rising ramp.  
MIDDLE : generates one trigger coincident with the peak of the rising ramp.

For details of local operation and parameter limitations, refer to *Section 4, Sub-Section 4.12* (Linear Ramp Function).

##### Response to Query Version

The instrument will return the <cpd> for the currently-selected trigger type.

#### 6.6.5.16 [SOUR]:PAR:SKEW:ALIGNment(?) <cpd>{DEFAULT|PRECISION}

##### Purpose

This command enables and disables the application of precision calibration to the Zero Skew output waveforms. Note that the Zero Skew offsets must have already been set up manually, as there is no command to perform this calibration via the remote interface.

A settings conflict will be reported if the Zero Skew function has not been selected.

##### <cpd>

DEFAULT : the inter-channel skew is set to default ( $\pm 50$ ps).

PRECISION : the precision adjustments, already carried out and stored manually, are applied.

For details of local operation and parameter limitations, refer to *Section 4, Sub-Section 4.14* (Zero Skew Function).

##### Response to Query Version

The instrument will return the <cpd> for the currently-selected trigger type.

#### 6.6.5.17 [SOUR]:PAR:TEL:LINE(?) <dnpd>

##### Purpose

This command selects the line frequency standard of the TV composite video function.

A settings conflict will be reported if the TELEvision function has not been selected.

##### <dnpd>

<600 : is rounded to select 525 line.

$\geq 600$  : is rounded to select 625 line.

For details of local operation and parameter limitations, refer to *Section 4, Sub-Section 4.11* (Composite Video Function).

##### Response to Query Version

The instrument will return the rounded <dnpd> for the currently-selected line frequency standard.

*Final Width = 215mm*

Final Width = 215mm

---

## 6.6.5 SOURCE Subsystem (Contd.)

### 6.6.5.19 [SOUR]:PAR:TEL:SYNC(?) <cpd>{COMP|FRAM}

#### Purpose

This command selects the sync standard of the TV function (available on the trigger channel if one has been selected).

A settings conflict will be reported if the TELEvision function has not been selected.

#### <cpd>

COMPOSITE : selects the full composite sync standard.  
FRAME : selects the frame sync standard.

For details of local operation and parameter limitations, refer to *Section 4, Sub-Section 4.11* (Composite Video Function).

#### Response to Query Version

The instrument will return the <cpd> for the currently-selected sync standard.

### 6.6.5.20 [SOUR]:PAR:TEL:LEV(?) <cpd>{BLAC|GREY|WHIT}

#### Purpose

This command selects one of the three amplitude levels of the TV waveform.

A settings conflict will be reported if the TELEvision function has not been selected.

#### <cpd>

BLACK : selects the black-level amplitude.  
GREY : selects a mid-level amplitude equivalent to a TV grey tone.  
WHITE : selects the white-level amplitude.

For details of local operation and parameter limitations, refer to *Section 4, Sub-Section 4.11* (Composite Video Function).

#### Response to Query Version

The instrument will return the <cpd> for the currently-selected amplitude level.

### 6.6.5.21 [SOUR]:PAR:TEL:POL(?) <cpd>{POS|NEG}

#### Purpose

This command inverts the polarity of the TV waveform.

A settings conflict will be reported if the TELEvision function has not been selected.

#### <cpd>

The 'character program data' <cpd>POS sets the output square wave in a positive direction, referred to ground. Similarly, <cpd>NEG sets the output square wave in a negative direction referred to ground.

For details of local operation and parameter limitations, refer to *Section 4, Sub-Section 4.11* (Composite Video Function).

#### Response to Query Version

The instrument will return the <cpd> for the currently-selected polarity.

### 6.6.5.22 [SOUR]:PAR:LEAK:STAT(?) <cpd>{OPEN | CLOS}

#### Purpose

This command selects the leakage function. The <cpd> parameters are used to determine which of the leakage currents are measured.

A settings conflict will be reported if the LEAKage function has not been selected.

#### <cpd>

OPEN : selects open-circuit output.  
CLOSE : selects short-circuit output.

For details of local operation and parameter limitations, refer to *Section 4, Sub-Section 4.14* (Input Leakage Function).

#### Response to Query Version

The instrument will return the <cpd> for the currently-selected open/short circuit state.

---

#### 6.6.5.23 [SOUR]:PAR:LEAK:TRIG(?) <cpd>{SING|CONT}

##### **Purpose**

This command selects the type of triggers associated with the leakage function.

Triggers are only produced if the output is on.

A settings conflict will be reported if the LEAKage function has not been selected.

##### **<cpd>**

- SINGLE : Generates one trigger coincident with each change of state of the open or close.
- CONTinuous : Selects a free running (100 Hz) trigger signal.

For details of local operation and parameter limitations, refer to *Section 4, Sub-Section 4.14* (Input Leakage Function).

##### **Response to Query Version**

The instrument will return the <cpd> for the currently-selected trigger type.

#### 6.6.5.24 [SOUR]:PAR:EXT

##### **Purpose**

This command selects the AUX INPUT signal for routing to any of the five channels. The required channel is selected using the ROUTe subsystem. Refer to *Section 4, Sub-Section 4.15.5* (Aux Input Function).

#### 6.6.5.25 [SOUR]:SCOPE:UUT\_Z(?) <dnpd>

##### **Purpose**

This command is for backwards compatibility with the 9100+250 and selects the impedance matching for the signal and trigger channels.

##### **<dnpd>**

- ≤55 : is rounded to select 50Ω.
- >55 : is rounded to select 1MΩ.

##### **Response to Query Version**

The instrument will return the rounded <dnpd> for the currently-selected UUT input impedance.

#### 6.6.5.26 [SOUR]:VOLT[:LEVE][:IMM][:AMPL](?) <dnpd>

##### **Purpose**

This command selects either DC or AC Voltage hardware, dependent upon the DC or SQU | EDGE | MARK | SIN | OPUL | TEL | LEAK | EXT parameter included in the most-recent FUNC command.

##### **<dnpd>**

The <dnpd> is a number which sets the required output voltage amplitude, expressed in units of DC or pk-pk AC Volts. It will automatically choose the 'best' hardware range for the defined voltage output. The 9500B will accept signed or unsigned positive values for DC Voltage. Only DC may be given a negative <dnpd>.

The voltage command will cancel the ground mode, if it is active.

##### **Response to Query Version**

The instrument will return the present DC or AC voltage output value, dependent upon the DC or SQU | EDGE | MARK | SIN | OPUL | TEL | LEAK | EXT parameter implicit, or included, in the most-recent FUNC command. The returned number will be in standard scientific format (for example: -20mV DC would be returned as -2.0E-2; positive numbers, however, are unsigned).

If the function is not selected, the query VOLT? will return the invalid number (2E35), or 0.0 if the output is grounded.

*Final Width = 215mm*

*Final Width = 215mm*

## 6.6.5 SOURce Subsystem (Contd.)

### 6.6.5.27 [SOUR]:CURR[:LEVE][:IMM][:AMPL](?) <dnpd>

#### Purpose

This command selects either DC or AC Current hardware, dependent upon the DC or SQU parameter included in the most-recent FUNC command.

#### <dnpd>

The <dnpd> is a number which sets the required output current amplitude, expressed in units of DC or pk-pk AC Amps. It will automatically choose the 'best' hardware range for the defined current output. The 9500B will accept signed or unsigned positive values for DC Current. Only DC may be given a negative <dnpd>.

A settings conflict will be reported if the DC or Square function has not been selected.

#### Response to Query Version

The instrument will return the present DC or AC current output value, dependent upon the DC or SQU parameter implicit, or included, in the most-recent FUNC command. The returned number will be in standard scientific format (for example: -200mA DC would be returned as  $-2.0E-1$ ; positive numbers, however, are unsigned).

If the function is not selected, the query CURR? will return the invalid number (2E35).

### 6.6.5.28 [SOUR]:FREQ[:CW|FIX](?) <dnpd>

#### Purpose

This command is used to set the frequency of the currently-selected waveform. The CW and FIXed optional parameters are included to stay with the SCPI definition of the frequency command. The command is valid only for AC waveshapes.

#### <dnpd>

The <dnpd> is a number which sets the required output frequency of the selected operation, expressed in units of Hertz. It will automatically choose the 'best' hardware range for the defined frequency of output.

#### Response to Query Version

The instrument will return the present output frequency value for the selected operation, dependent upon the parameter implicit, or included, in the most-recent FUNC command, and the most-recent VOLT or CURR command. The returned number will be in standard scientific format (20kHz would be returned as  $2.0E4$ ).

### 6.6.5.29 [SOUR]:PER[:CW|FIX](?) <dnpd> [SOUR]:SPER[:CW|FIX](?) <dnpd>

#### Note

The SPERiod command is used for backward compatibility with Option 250 in the 9100. In the 9100, the SPER command was available only in Edge and Timing Markers functions, but in the 9500B, the PER command is available in all applicable functions.

#### Purpose

This command is used to set the period of the currently-selected waveform. The CW and FIXed optional parameters are included to stay with the SCPI definition of the period command. The command is valid only for AC waveshapes.

#### <dnpd>

The <dnpd> is a number which sets the required output period of the selected operation, expressed in units of Seconds. It will automatically choose the 'best' hardware range for the defined period of output.

#### Response to Query Version

The instrument will return the present output period value for the selected operation, dependent upon the parameter implicit, or included, in the most-recent FUNC command, and the most-recent VOLT or CURR command. The returned number will be in standard scientific format (50 $\mu$ s would be returned as  $5.0E-5$ ).

### 6.6.5.30 SOUR:WIDT[:CW|FIX](?)<dnpd>

#### Purpose

This command is used to set the width of the pulse waveform. The amplitude of the pulse is fixed but the frequency can be modified with the SOURce:FREQuency command. The CW and FIXed optional parameters are included to provide continuity with other similar commands. The command is only valid for the PWIDth function.

#### <dnpd>

The <dnpd> is a number which sets the required pulse width, expressed in units of Seconds.

#### Response to Query Version

The instrument will return the present width value for the pulse. The returned number will be in standard scientific format. (50 $\mu$ s would be returned as  $5.0E-5$ ).

---

## 6.6.6 CONFigure Subsystem

This subsystem is used to select the input resistance or input capacitance measurement mode.

### Note about Measurement in the 9500B:

There are only two parameters that a 9500B can measure: the UUT input capacitance and the UUT input resistance. These are simple measurements with the user having no control over read rate, resolution, trigger timing, etc.

Note that the Group Execute Trigger (GET) is not available on the 9500B. (The instrument is configured with 'DT0' interface capability: 'no device trigger capability'.)

### 6.6.6.1 CONFigure[:RESistance|CAPacitance]

#### Purpose

This command is used to select the UUT input resistance or capacitance measurement function as appropriate. Exit from the measurement function via the `SOURce:FUNCTion:SHAPE` commands.

Any command that is received that cannot be executed (e.g. `:VOLT`, `:FREQ` etc.) will generate a 'settings conflict' error.

### 6.6.6.2 CONFigure[?]

#### Response to Query

The instrument will return either 'RES' or 'CAP' if the measurement function is selected, or 'NONE' if not selected.

### 6.6.6.3 READ?

#### Purpose

This query-only command is used to return the most-recent measurement for either the UUT input resistance or capacitance function as appropriate.

#### Response to Query

This command will return the last measurement taken for either the resistance or capacitance function (as appropriate).

#### Resistance

In the case of successfully measuring the resistance value of the UUT, this command will return a number within the approximate range of 10 to 150 or 50E3 to 20E6 depending on the setting of the 9500B channel impedance.

#### Capacitance

In the case of successfully measuring the capacitance value of the UUT, this command will return a number within the approximate range of 1.0E-12 to 120.0E-12.

#### Value Cannot be Resolved

If the resistance or capacitance is selected, but the measurement is unable to resolve a value (i.e. no scope connected) then the value 2E35 will be returned.

#### Neither RESistance nor CAPacitance Selected

If neither `RESistance` nor `CAPacitance` is selected, this command will return 2E35.

**Note** According to the SCPI spec, if a measurement is requested when it is not possible to perform the task (i.e. output off, function not selected, etc.) then the message -230, 'Data corrupt or stale' is put in the error buffer. NO READING IS RETURNED. This may hang the bus if the user application is poorly written because the controller will be expecting an answer to its query command. For user-friendliness a value of 2E35 is always returned.

*Final Width = 215mm*

Final Width = 215mm

## 6.6.7 STATus Subsystem

This subsystem is used to enable bits in the Operation and Questionable Event registers. The Operation and Questionable: Event, Enable and Condition registers can be interrogated to determine their state. For further information regarding the Status structure, refer to *Sub-Section 6.5*.

### 6.6.7.1 STATus Subsystem Table

Keyword	Parameter Form
STATus	
:OPERation	
[:EVENTi?]	
:ENABle(?)	<dnpd>
:CONDition?	
:QUESTionable	
[:EVENTi?]	
:ENABle(?)	<dnpd>
:CONDition?	
:PRESet	

### 6.6.7.2 STAT:OPER[:EVEN]?

#### Purpose

STAT:OPER? returns the contents of the Operation Event register, clearing the register.

#### Response

A <dnpd> in the form of an Nr1 number is returned. The value of the number, when converted to base 2 (binary), identifies the Operation Event register bits to determine their current status.

For example (refer to Fig. 6.2):

If the 9500B had just performed a selftest, the 'TESTING' bit 8 of the register would be set, and if no other Operation Event bits were enabled, the number 256 would be returned. Bit 8 (indeed, all bits in the register) would be reset by this query.

### 6.6.7.3 STAT:OPER:ENAB(?) <dnpd>

#### Purpose

STAT:OPER:ENAB <dnpd> sets the mask which enables those Operation Event register bits which are required to be summarized at bit 7 of the IEEE 488.2 Status Byte register.

#### <dnpd>

This is a decimal integer whose binary equivalent represents the bits required to be enabled.

For example (refer to Fig. 6.2 and paras 6.5.4):

The command: STAT:OPER:ENAB 272 would be required to enable only the 'TESTING' and 'MEASURING' bits 8 and 4 of the Operation Event register.

#### Response to the Query Version

A <dnpd> in the form of an Nr1 number is returned. The value of the number, when converted to base 2 (binary), identifies the bits set in the Operation Enable mask.

For example (refer to Fig. 6.2 and paras 6.5.4):

If only the 'MEASURING' and 'CALIBRATING' bits 4 and 0 of the register are enabled, the number 17 would be returned.

### 6.6.7.4 STAT:OPER:COND?

#### Purpose

STAT:OPER:COND? returns the contents of the Operation Condition register (not shown in Fig. 6.2), which is not cleared by the command.

**N.B.** This register contains transient states, in that its bits are not 'sticky', but are set and reset by the referred operations. The response to the query therefore represents an instantaneous 'Snapshot' of the register state, at the time that the query was accepted.

#### Response

A <dnpd> in the form of an Nr1 number is returned. The value of the number, when converted to base 2 (binary), identifies the Operation Condition register bits to determine their current status.

For example (refer to Fig. 6.2):

If the 9500B was in the process of performing a selftest, only the 'TESTING' bit 8 of the register would be temporarily set, and the number 256 would be returned.

---

## 6.6.7 STATus Subsystem *(Contd.)*

### 6.6.7.5 STAT:QUES:[EVEN]?

#### Purpose

STAT:QUES? returns the contents of the Questionable Event register, clearing the register.

#### Response

A <dnpd> in the form of an Nr1 number is returned. The value of the number, when converted to base 2 (binary), identifies the Questionable Event register bits to determine their current status.

For example (*refer to Fig. 6.2 and paras 6.5.4*):

If an error had been initiated by a doubtful measurement during resistance operations, the 'sticky' 'RESISTANCE' bit 12 of the register would be set, and if no other Questionable Event bits were enabled, the number 4096 would be returned. Bit 12 (indeed, all bits in the register) would be reset by this query.

### 6.6.7.6 STAT:QUES:ENAB(?) <dnpd>

#### Purpose

STAT:QUES:ENAB <dnpd> sets the mask which enables those Questionable Event register bits which are required to be summarized at bit 3 of the IEEE 488.2 Status Byte register.

#### <dnpd>

This is a decimal integer whose binary equivalent represents the bits required to be enabled.

For example (*refer to Fig. 6.2 and paras 6.5.4*):

The command: STAT:QUES:ENAB 6144 would be required to enable only the 'RESISTANCE' and 'CAPACITANCE' bits 12 and 11 of the Questionable Event register.

#### Response to the Query Version

A <dnpd> in the form of an Nr1 number is returned. The value of the number, when converted to base 2 (binary), identifies the bits set in the Questionable Enable mask.

For example (*refer to Fig. 6.2 and paras 6.5.4*):

If the 'CAPACITANCE' bit 11 of the register is the only enabled bit, the number 2048 would be returned.

### 6.6.7.7 STAT:QUES:COND?

#### Purpose

STAT:QUES:COND? returns the contents of the Questionable Condition register (not shown in Fig. 6.2), which is not cleared by the command.

**N.B.** This register contains transient states, in that its bits are not 'sticky', but are set and reset by the referred conditions. The response to the query therefore represents an instantaneous 'Snapshot' of the register state, at the time that the query was accepted.

#### Response

A <dnpd> in the form of an Nr1 number is returned. The value of the number, when converted to base 2 (binary), identifies the Questionable Condition register bits to determine their current status.

For example (*refer to Fig. 6.2*):

If a doubtful measurement was generating an error during Capacitance operations, and the temporary 'CAPACITANCE' bit 11 of the Condition register was set; and if no other Questionable Condition bits were set, the number 2048 would be returned.

### 6.6.7.8 STAT:PRES

#### SCPI-Mandated Command

The intention behind mandating the STAT:PRES command is to enable all bits in the SCPI-defined 'Device-dependent' and 'Transition' registers in order to provide a "device-independent structure for determining the gross status of a device".

#### Purpose in the 9500B

In the 9500B, the functions of the 'Transition' registers are not required, so no access is given. The PRES command therefore affects only the two device-dependent enabling registers:

The Operation Event Enable register

The Questionable Event Enable register.

Refer to Fig. 6.2. Sending STAT:PRES will set true all bits in both Enable registers. This will enable all bits in the two Event registers, so that all reportable device-dependent events, reported in the two registers, will be capable of generating an SRQ; providing only that bits 3 and 7 in the IEEE-488.2 Status Byte Register are also enabled.

The use of STAT:PRES in the 9500B allows the status-reporting structure to be set to a known state, not only for the intention of the SCPI mandate, but also to provide a known starting point for application programmers.

*Final Width = 215mm*

Final Width = 215mm

## 6.6.8 SYSTem Subsystem

This subsystem collects the functions that are not related to 9500B performance.

### 6.6.8.1 SYSTem Subsystem Table

Keyword	Parameter Form
SYSTem	
:ERRor?	
:DATE(?)	<spd>
:TIME(?)	<spd>
:SVOLtage(?)	<dnpd>
:VERSion?	
:FORMat?	

### 6.6.8.2 SYST:ERR?

#### The Error Queue

As errors in the 9500B are detected, they are placed in a 'first in, first out' queue, called the 'Error Queue'. This queue conforms to the format described in the SCPI Command Reference (Volume 2), although errors only are detected. Three kinds of errors are reported in the Error Queue, in the sequence that they are detected:

**Command Errors, Execution Errors and Device-Dependent errors**

#### Queue Overflow

Any time the Error Queue overflows, the earliest errors remain in the queue, and the most-recent error is discarded. The latest error in the queue is replaced by the error: -350, "Queue overflow".

#### Purpose of SYST:ERR? — Reading the Error Queue

This query is used to return any error which has reached the head of the Error Queue, and delete the error from the queue. The Error Queue is first in / first out, so the returned string will represent the earliest error in the queue.

The queue is read destructively as described in the SCPI Command Reference to obtain a code number and error message. The query can be used successively to read errors in the queue until it is empty, when the message 0, "No error" will be returned.

#### Response

The response is in the form of 'String Program Data', and consists of two elements: a code number and error message.

The list of possible responses is given in *Appendix 'A' to Section 8*.

### 6.6.8.3 SYST:DATE(?)<spd>

The date *format* can only be changed locally; using the **Date Format** menu, which is accessed via the **Configuration** menus.

**N.B.** A password is required for access to change the date format. Refer to *Section 3, Subsection 3.4.3, paras 3.4.3.1 and 3.4.3.12*.

#### Purpose

This command is not used to change the date format. It only changes the present date, as recognized by the 9500B, within the *current* date format, as defined locally.

#### <spd>

This string defines the present date, and consists of the three two-digit numbers, separated by forward slashes. The numbers represent day, month and year, but not necessarily in that order. The locally-defined date format governs the sequence in which these three numbers are recognized, and their order within the string must reflect the locally-defined sequence.

#### Possible Formats

The string must conform to the scheme: dd,mm,yyyy where the chosen sequence agrees with that set locally in *paras 3.4.3.12*.

**dd/mm/yyyy or mm/dd/yyyy or yyyy/mm/dd**

#### Response to Query Version SYST:DATE?

The Query will return the presently-programmed date, as three slash-separated two-digit numbers, in the date format that they are currently set.



---

#### 6.6.8.4 SYST:TIME(?) <spd>

##### **Purpose**

This command changes the present time as recorded by the 9500B software. Any new time will be updated from a non-volatile real-time internal 24-hour clock.

##### **<spd>**

This string defines the present time, consisting of two 2-digit numbers, separated by a hyphen. The numbers represent hour and minute, in that order. Their order within the string must reflect the fixed sequence.

The string must conform to the scheme: X-Y, where X and Y are 2-digit numbers.

The combination of the 2-digit numbers must have the following meaning, within the context of a 24-hour clock:

##### **Hour-Minute**

##### **Response to Query Version SYST:TIME?**

The Query will return the updated time at the moment the query was accepted, as two hyphen-separated 2-digit numbers, in the fixed time format.

#### 6.6.8.5 SYST:SVOL (?) <dnpd>

##### **Purpose**

This command sets the voltage value of the threshold of operation for the High Voltage Warning as employed in DC Voltage and AC Voltage functions. The 9500B need not be currently set in either of these functions to program the voltage.

##### **<dnpd>**

The 'decimal numeric program data' is a number which sets the required voltage safety warning threshold, expressed in units of DC or Pk-Pk AC Volts. It should be unsigned. The parameter <dnpd> must have a value in the range 10.00V to 110.00V inclusive.

##### **Response to Query Version: SYST:SVOL?**

The instrument will return the present DC or AC voltage safety warning threshold value. The returned number will be in standard scientific unsigned format (for example: 90V would be returned as 9.0E1).

#### 6.6.8.6 SYST:VERS?

##### **Purpose**

This query returns a numeric value corresponding to the SCPI version number for which the 9500B complies.

##### **Response**

SYST:VERS? returns an <Nr2> formatted numeric value corresponding to the SCPI version number for which the 9500B complies. At the time of writing, this will be 1994.0.

#### 6.6.8.7 SYST:FORM?

##### **Purpose**

This query returns the present date format, as programmed locally.

##### **Response**

SYST:FORM? returns one of three sets of three characters: **DMY**, **MDY** or **YMD** (**Day/Month/Year**, **Month/Day/Year** or **Year/Month/Day** respectively). Formatting is carried out from a screen in 'Configuration' mode (*Refer to Section 3, Subsection 3.4.3, paras 3.4.3.12*).

*Final Width = 215mm*

---

*Final Width = 215mm*  
LEFT BLANK

## IEEE 488.2 Device Documentation Requirements

IEEE 488.2 requires that certain information be supplied to the user about how the device has implemented the standard. The Device Documentation Requirements are detailed in Section 4.9 of the Standard document IEEE Std 488.2-1992, on page 22. In this handbook, the required information is already contained within the descriptions of the system, and this appendix provides cross-references to those descriptions in which it is presented. The following paragraphs have the same numbers as the paragraphs of Section 4.9 in the Standard document to which they refer.

1. The list of IEEE 488.1 Interface Functions subsets implemented is given as Table 6.1 (page 6.3-1). The list is also printed close to the IEEE 488 connector on the rear of the instrument.
2. The instrument address is set manually, and the instrument firmware refuses to set any address outside the range 0-30. It responds instead with a Device Dependent Error, displayed on the front panel screen:  
"Bus address must be within the range 0 - 30".
3. The (manual only) method of setting the address is described on pages 6.4-1, including the point in time when the 9500B recognizes a user-initiated address change.
4. Appendix E to Section 6 describes the active and non-active settings at power-on.
5. Message Exchange Options:
  - a. The Input Buffer is a first in - first out queue, which has a maximum capacity of 128 bytes (characters). Each character generates an interrupt to the instrument processor which places it in the Input Buffer for examination by the Parser. The characters are removed from the buffer and translated with appropriate levels of syntax checking. If the rate of programming is too fast for the Parser or Execution Control, the buffer will progressively fill up. When the buffer is full, the handshake is held.
  - b. No query returns more than one <RESPONSE MESSAGE UNIT>.
  - c. All queries generate a response when parsed.
  - d. No query generates a response when read.

*Final Width = 215mm*

*Final Width = 215mm*

- 
6. The following functional elements are used in constructing the device-specific commands:
    - Command Program Header
    - Query Program Header
    - Character Program Data
    - Decimal Numeric Program Data.
    - String Program Data (PASS, EXIT, DATE, TIME)
    - Arbitrary Block Program Data (\*PUD)
    - Arbitrary ASCII Response Data (to ROUTe:FITTeD?)No Compound Command Program Headers are used within the SCPI format.
  7. \*PUD blocks are limited to 63 bytes.
  8. Expression Program Data elements are not used.
  9. The syntax for each command is described in the general list of commands in Subsection 6.6 and Section 6, Appendix C. This list includes all queries, for which the response syntax is also described.
  10. All device-to-device message transfer traffic follows the rules for <RESPONSE MESSAGE> elements.
  11. The only command which elicits a Block Data response is the query \*PUD?. Its response consists of #, 2, two digits and a data area of 63 bytes; 67 bytes in all.
  12. A separate list of every implemented Common Command and Query is given in the alphabetical index in Section 6, subsection 6.2.1.  
They are also described in Section 6, Appendix C
  13. \*CAL? is not implemented.
  14. \*DDT is not implemented.
  15. Macro commands are not implemented.
  16. \*IDN? is described in Section 6, Appendix C.
  17. \*DDT is not implemented.
  18. Neither \*RDT nor \*RDT? are implemented.
  19. The states affected by \*RST are described for each command in the list of commands and queries in Section 6, Appendix C.  
Query Command \*LRN? is not implemented; neither are Commands \*RCL and \*SAV.
  20. \*TST? invokes the Operational Selftest . The response to \*TST? is described in Section 6, Appendix C, with a list of possible errors detailed in Appendix A to Section 8 of this handbook.
  21. The additional status data structures used in the instrument's status reporting are fully described in Section 6; Subsection 6.5.  
Operating instructions for the status reporting facilities are given in Section 6, Appendix C.
  22. All commands are sequential - overlapped commands are not used.
  23. As all commands are sequential, there are no pending parallel operations. The functional criterion which is met, therefore, is merely that the associated operation has been completed.
  24. No representations are used for 'Infinity' and 'Not-a-Number'.

## IEEE 488.2 Common Commands and Queries Implemented in the Model 9500B

### 6.C.1 Clear Status

This command conforms to the IEEE 488.2 standard requirements.

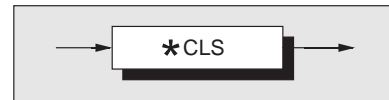

**\*CLS**  
clears all the event registers and queues except the output queue. The output queue and MAV bit will be cleared if \*CLS immediately follows a 'Program Message Terminator'; refer to the IEEE 488.2 standard document.

**Execution Errors:**

None.

**Power On and Reset Conditions**

Not applicable.

*Final Width = 215mm*

---

### 6.C.2 Event Status Enable

This event status data structure conforms to the IEEE 488.2 standard requirements for this structure.

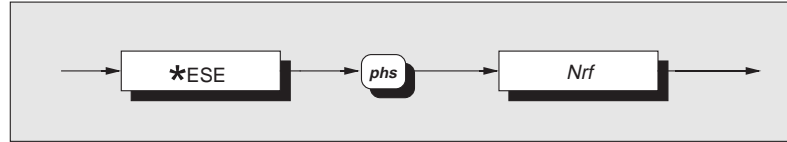

**\*ESE** enables the standard defined event bits which will generate a summary message in the status byte. Refer to Section 6; Subsection 6.5.

None.

**Power On and Reset Conditions**  
Not applicable.

*Nrf* is a Decimal Numeric Data Element representing an integer decimal value equivalent to the Hex value required to enable the appropriate bits in this 8-bit register. The detailed definition can be found in section 6.5.3.5. Note that numbers **will** be rounded to an integer.

Final Width = 215mm

#### Execution Errors:

---

### 6.C.3 Recall Event Status Enable

This event status data structure conforms to the IEEE 488.2 standard requirements for this structure.

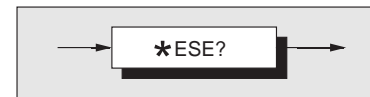

**\*ESE?** recalls the enable mask for the standard defined events. Refer to Section 6; Subsection 6.5.

#### Execution Errors:

None

#### Response Decode:

The value returned, when converted to base 2 (binary), identifies the enabled bits which will generate a summary message in the service request byte, for this data structure.

#### Power On and Reset Conditions

The Power On condition depends on the condition stored by the common \*PSC command - if 0 then it is not cleared; if 1 then the register is cleared. Reset has no effect.

---

#### 6.C.4 Read Event Status Register

This event status data structure conforms to the IEEE 488.2 standard requirements for this structure.

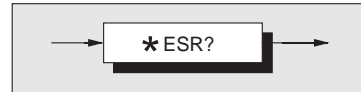

##### **\*ESR?**

recalls the standard defined events.  
Refer to Section 6; Subsection 6.5.

##### **Response Decode:**

The value returned, when converted to base 2 (binary), identifies the bits as defined in the IEEE 488.2 standard.

##### **Execution Errors:**

None

*Final Width = 215mm*

---

### 6.C.5 I/D (Instrument Identification)

This command conforms to the IEEE 488.2 standard requirements.



#### \*IDN?

will recall the instrument's manufacturer, model number, serial number and firmware level.

#### Response Format:

Character position																														
1	2	3	4	5	6																									
F	l	u	k	e	,																									
7	8	9	10	11	12																									
9	5	0	0	B	,																									
13	14	15	16	17	18	19	20	21	22	23	24	25																		
X	X	X	X	X	X	X	X	X	X	X	X	X	,																	
26	27	28	29	30																										
X	.	X	X	,																										

*Final Width = 215mm*

#### Where:

The data contained in the response consists of four comma-separated fields, the last two of which are instrument-dependent. The data element type is defined in the IEEE 488.2 standard specification.

A single query sent as a terminated program message will elicit a single response terminated by:

nl = newline with EOI

If multiple queries are sent as a string of program message units (separated by semi-colons with the string followed by a permitted terminator), then the responses will be returned as a similar string whose sequence corresponds to the sequence of the program queries. The final response in the string will be followed by the terminator:

nl = newline with EOI

#### Response Decode:

The data contained in the four fields is organized as follows:

- First field - manufacturer
- Second field - model
- Third field - serial number
- Fourth field - firmware level (will possibly vary from one instrument to another).

#### Execution Errors:

None.

#### Power On and Reset Conditions

Not applicable.



---

### 6.C.6 Operation Complete

This command conforms to the IEEE 488.2 standard requirements.

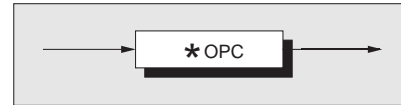

**\*OPC**  
is a synchronization command which will generate an operation complete message in the standard Event Status Register when all pending operations are complete.

**Execution Errors:**

None.

**Power On and Reset Conditions**

Not applicable.

---

### 6.C.7 Operation Complete?

This query conforms to the IEEE 488.2 standard requirements.

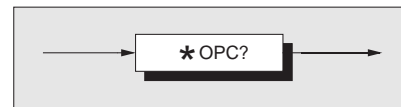

**Response Decode:**

The value returned is always 1, which is placed in the output queue when all pending operations are complete.

*Final Width = 215mm*

---

### 6.C.8 Recall the 9500B Instrument Hardware Fitment

This command conforms to the IEEE 488.2 standard requirements.

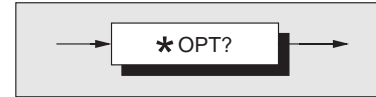

#### **\*OPT?**

will recall the instrument's hardware fitment.

#### **Response Format:**

Character position:

1	2	3	4	5	6	7	8	9	10	11	12
Ch1	,	Ch2	,	Ch3	,	Ch4	,	Ch5	,	x1	,
13	14	15	16	17	18	19	20				
8	s	s	s	s	s	s	nl				

#### **Response Decode:**

The character positions represent the following hardware fitment:

Ch1-Ch5: Active Head Fitment to Specified Channel

*where:*

ChX = Ø: No Active Head Fitted

ChX = 1: Active Head Fitted

x1: Option 100: High Stability Crystal Reference

*where:*

x1 = 1: indicates that option 100 is fitted,

x1 = 0: indicates that option 100 is not fitted.

s: Base Frequency Field

#### **Where:**

The data in the response consists of comma-separated characters, each being either 1 or Ø.

nl = newline with EOI

The data element type is Nr1 as defined in the IEEE 488.2 standard specification.

#### **Execution Errors:**

None.

#### **Power On and Reset Conditions**

Not applicable.

*Final Width = 215mm*

---

### 6.C.9 Power On Status Clear

This common command conforms to the IEEE 488.2 standard requirements.

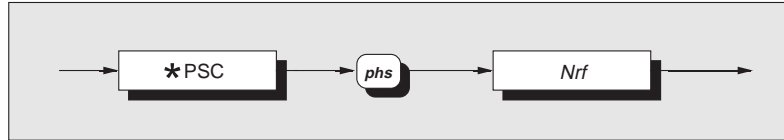

#### \*PSC

sets the flag controlling the clearing of defined registers at Power On.

**Nrf** is a decimal numeric value which, when rounded to an integer value of zero, sets the *power on clear flag false*. This allows the instrument to assert SRQ at power on, providing that the PON bit in the ESR is enabled at the time of power-down, by the corresponding bit in its Enable register (ESE).

When the value rounds to an integer value other than zero it sets the *power on clear flag true*, which clears the standard *event status enable* and *service request enable* registers so that the instrument will not assert an SRQ on power up.

#### Examples:

\*PSC 0 or \*PSC 0.173 sets the instrument to **assert** an SRQ at Power On.

\*PSC 1 or \*PSC 0.773 sets the instrument to **not assert** an SRQ on Power On.

#### Execution Errors:

None.

#### Power On and Reset Conditions

Not applicable.

*Final Width = 215mm*

---

### 6.C.10 Recall Power On Status Clear Flag

This common query conforms to the IEEE 488.2 standard requirements. The existing flag condition will have been determined by the \*PSC command.

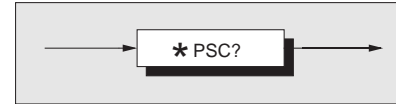

#### \*PSC?

will recall the Power On Status condition.

#### Response Format:

A single ASCII character is returned.

A single query sent as a terminated program message will elicit a single response terminated by:

nl = newline with EOI

If multiple queries are sent as a string of program message units (separated by semi-colons with the string followed by a permitted terminator), then the responses will be sent as a similar string whose sequence corresponds to the sequence of the program queries. The final response in the string will be followed by the terminator:

nl = newline with EOI

#### Response Decode:

The value returned identifies the state of the saved flag:

**Zero** indicates **false**. The instrument **is not** programmed to clear the Standard Event Status Enable Register and Service Request Enable Register at Power On, so the instrument will generate a 'Power On' SRQ, providing that the PON bit in the ESR is enabled at the time of power-down, by the corresponding bit in its Enable register (ESE).

**One** indicates **true**. The instrument **is** programmed to clear the Standard Event Status Enable Register and Service Request Enable Register at Power On, so the instrument cannot generate any SRQ at Power On.

#### Execution Errors:

None

#### Power On and Reset Conditions

No Change. This data is saved in non-volatile memory at Power Off, for use at Power On.

*Final Width = 215mm*

### 6.C.11 Protected User Data — Entry of User Data

This command conforms to the IEEE 488.2 standard requirements.

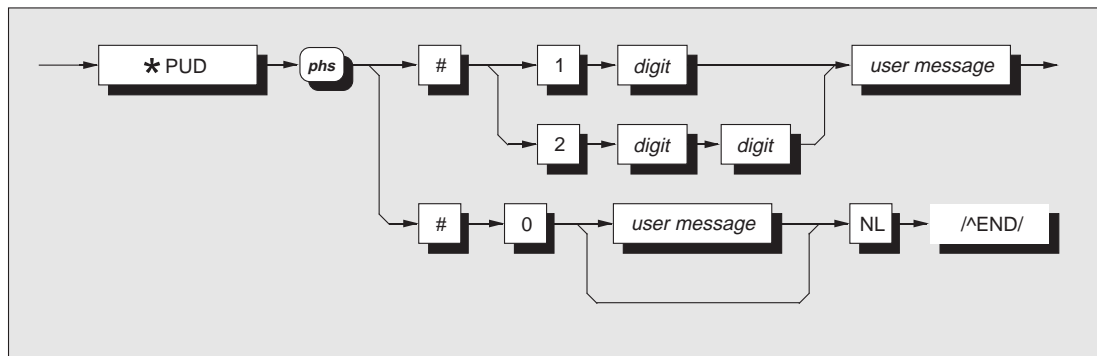

#### where:

*phs* = Program Header Separator,  
*digit* = one of the ASCII-coded numerals,  
*user message* = any message up to 63 bytes maximum.

*Final Width = 215mm*

#### Note

The slash-delimited /^END/ box is not outlined. This is to draw attention to the fact that it is not a data element, but represents the EOI line being set true with the last byte 'NL' to terminate the program message. Refer to the *Standard document IEEE Std 488.2-1992, Sub-section 7.7.6, page 78.*

#### \*PUD

allows a user to enter up to 63 bytes of data into a protected area to identify or characterize the instrument. The two representations above are allowed depending on the message length and the number of 'digits' required to identify this. The instrument must be in calibration mode for this command to execute.

The data can be recalled using the \*PUD? query.

#### Execution Errors

\*PUD is executable only when the rear panel calibration switch is in the enabled position *and* calibration has been enabled. Otherwise an Execution Error is returned.

#### Command Errors

A Command Error is returned if the user message exceeds 63 bytes, or if the data does not conform to the standard format.

#### Power On and Reset Conditions

Data area remains unchanged.

---

### 6.C.12 Protected User Data — Recall of User Data

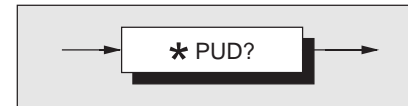

This common command conforms to the IEEE 488.2 standard requirements.  
\***PUD?** recalls previously entered user data. Refer to program command \***PUD**.

#### Response Syntax:

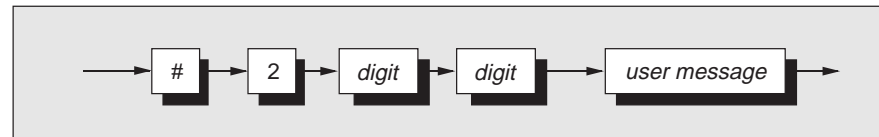

*Final Width = 215mm*

#### where:

*digit* = one of the ASCII-coded numerals previously determined from the length of the user message string,  
*user message* = the saved user message.

#### Response Decode:

The previously-saved message is recalled.  
If no message is available, the value of the two digits is 00. The data area contains up to 63 bytes of data.

A single query sent as a terminated program message will elicit a single response terminated by:

nl = newline with EOI

If multiple queries are sent as a string of program message units (separated by semi-colons with the string followed by a permitted terminator), then the responses will be sent as a similar string whose sequence corresponds to the sequence of the program queries. The final response in the string will be followed by the terminator:

nl = newline with EOI

#### Execution Errors:

None.

#### Power On and Reset Conditions

Data area remains unchanged.

---

### 6.C.13 Reset

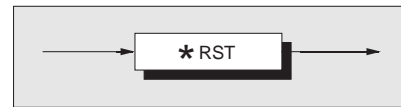

#### **\*RST**

will reset the instrument to a defined condition, stated for each applicable command with the command's description, and listed in Appendix D to Section 6.

The reset condition is not dependent on past-use history of the instrument except as noted below:

\*RST does not affect the following:

- the selected address of the instrument;
- calibration data that affect specifications;
- SRQ mask conditions;
- the state of the IEEE 488.1 interface.

#### **Execution Errors:**

None.

#### **Power On and Reset Conditions**

Not applicable.

*Final Width = 215mm*

---

### 6.C.14 Service Request Enable

This Status Byte data structure conforms to the IEEE 488.2 standard requirements for this structure.

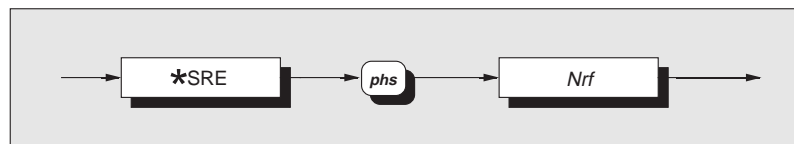

\*SRE enables the standard and user-defined summary bits in the service request byte, which will generate a service request. Refer to Section 6, Subsection 6.5.

*Nrf* is a Decimal Numeric Data Element representing an integer decimal value equivalent to the Hex value required to enable the appropriate bits in this 8-bit register. The detail definition is contained in the IEEE 488.2 document. Note that numbers **will** be rounded to an integer.

#### **Execution Errors:**

None.

#### **Power On and Reset Conditions**

Not applicable.

---

### 6.C.15 Recall Service Request Enable

This Status Byte data structure conforms to the IEEE 488.2 standard requirements for this structure.

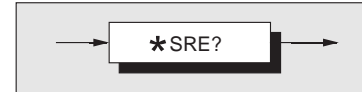

#### **\*SRE?**

recalls the enable mask for the standard defined events. Refer to Section 6, Subsection 6.5.

#### **Response Decode:**

The value returned, when converted to base 2 (binary), identifies the enabled bits which will generate a service request. The detail is contained in the IEEE 488.2 standard document.

#### **Execution Errors:**

None.

#### **Power On and Reset Conditions**

The Power On condition depends on the condition stored by the common \*PSC command - if 0 then it is not cleared; if 1 then the register is cleared. Reset has no effect.

*Final Width = 215mm*

---

### 6.C.16 Read Service Request Register

This Status Byte data structure conforms to the IEEE 488.2 standard requirements for this structure.

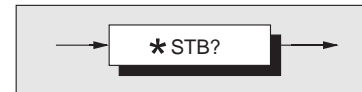

#### **\*STB?**

recalls the service request register for summary bits. Refer to Section 6, Subsection 6.5.

#### **Response Decode:**

The value returned, when converted to base 2 (binary), identifies the summary bits for the current status of the data structures involved. For the detail definition see the IEEE 488.2 standard document. There is no method of clearing this byte directly. Its condition relies on the clearing of the overlying status data structure.

#### **Execution Errors:**

None.

#### **Power On and Reset Conditions**

Not applicable.



---

### 6.C.17 Test Operations — Full Selftest

This query conforms to the IEEE 488.2 standard requirements.

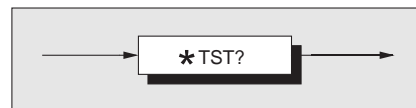

#### **\*TST?**

executes a Full selftest. A response is generated after the test is completed.

**N.B.** Operational selftest is valid only at temperatures:  $23^{\circ}\text{C}\pm 10^{\circ}\text{C}$ .

#### **Response Decode:**

The value returned identifies pass or failure of the operational selftest:

**ZERO** indicates operational selftest complete with no errors detected.

**Non-zero** indicates operational selftest has failed. The number itself represents the number of test failures.

The failure codes can be found only by re-running the self test manually. Refer to Section 8.

#### **Execution Errors:**

Operational selftest is not permitted when calibration is successfully enabled.

#### **Power On and Reset Conditions**

Not applicable.

*Final Width = 215mm*

---

### 6.C.18 Wait

This command conforms to the IEEE 488.2 standard requirements.

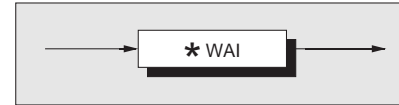

#### **\*WAI**

prevents the instrument from executing any further commands or queries until the *No Pending Operations Flag* is set true. This is a mandatory command for IEEE-488.2 but has little relevance to this instrument as there are no parallel processes requiring Pending Operation Flags.

#### **Execution Errors:**

None.

#### **Power On and Reset Conditions**

Not applicable.

*Final Width = 215mm*

## Model 9500B — Device Settings after \*RST & Power On

### 6.D.1 Introduction

#### \*RST

will reset the instrument to a defined condition, stated for each applicable command.

The reset condition is not dependent on past-use history of the instrument except as noted below:

\*RST *does not* affect the following:

- the selected address of the instrument;
- calibration data that affect specifications;
- SRQ mask conditions;
- the contents of:
  - the Status Byte Register;
  - the Status Byte Enable Register;
  - the Standard Event Status Register;
  - the Standard Event Status Enable Register;
  - the SCPI Operation Status Register;
  - the SCPI Operation Status Enable Register;
  - the SCPI Questionable Status Register;
  - the SCPI Questionable Status Enable Register;
- the state of the IEEE 488.1 interface;
- the Error Queue;
- the Power-on Status Clear flag setting;
- the Protected User Data Query response.

The 'Enable Macro Command' (\*EMC) is not used.

The 'Define Device Trigger Command' (\*DDT) is not used.

Parallel Poll is not implemented in the 9500B.

\*RST enforces the following states:

- The 9500B reverts to Manual/Procedure mode;
- the 9500B is returned to 'Operation Complete Command Idle State' (OCIS);

- the 9500B is returned to 'Operation Complete Query Idle State' (OQIS);
- Settings Related to Common IEEE 488.2 Commands are as detailed in paras 6.D.2, overleaf;
- Settings related to SCPI Commands are as detailed in paras 6.D.3, overleaf;

### 6.D.2 General

**Active Mode:** The 9500 can power-up in either 'Manual' or 'Procedure' mode, but Manual Mode or Calibration mode must be selected for Remote Operation. The required mode is selected by pressing **Mode** key on front panel and choosing from the Mode Menu (Calibration mode requires a password).

**Device I/D (Serial Number)** Factory serial number preserved  
**Protected User Data** Previous entry preserved

#### Status Reporting Conditions:

<b>Status Byte Register</b>	Depends on state of *PSC
<b>Status Byte Enable Register</b>	Depends on state of *PSC
<b>Event Status Register</b>	Depends on state of *PSC
<b>Event Status Enable Register</b>	Depends on state of *PSC
<b>Operation Status Event Register</b>	Depends on state of *PSC
<b>Operation Status Enable Register</b>	Depends on state of *PSC
<b>Questionable Status Event Register</b>	Depends on state of *PSC
<b>Questionable Status Enable Register</b>	Depends on state of *PSC
<b>Error Queue</b>	Empty until first error is detected

*Final Width = 215mm*

---

### 6.D.3 \*RST Settings Related to Common IEEE 488.2 Commands

Program Coding	Condition
*CLS	Not applicable
*ESE Nrf	Not applicable
*ESE?	Previous state preserved
*ESR?	Previous state preserved
*IDN?	No Change
*OPC	OPIC state forced
*OPC?	OPIQ state forced
*OPT?	Not applicable
*PSC 0/1	Not applicable
*PSC?	No change.
*PUD	Data area remains unchanged
*PUD?	Data area remains unchanged
*SRE Nrf	Not applicable
*SRE?	Previous state preserved
*STB?	Previous state preserved
*TST?	Not applicable
*WAI	Not applicable

*Final Width = 215mm*

### 6.D.4 Power-On Settings Related to Common IEEE 488.2 Commands

Program Coding	Condition
*CLS	Not applicable
*ESE Nrf	Not applicable
*ESE?	Response depends on state of *PSC
*ESR?	Response depends on state of *PSC
*IDN?	Not applicable
*OPC	Not applicable
*OPC?	Not applicable
*OPT?	Not applicable
*PSC 0/1	Not applicable
*PSC?	No change. This data is saved at power off for use at power on.
*PUD	Data area remains unchanged
*PUD?	Data area remains unchanged
*RST	Not applicable
*SRE Nrf	Not applicable
*SRE?	Response depends on state of *PSC
*STB?	Response depends on state of *PSC
*TST?	Not applicable
*WAI	Not applicable

---

## 6.D.5 \*RST & Power On Settings Related to SCPI Commands

Keyword	Condition
CALibration .....	Disabled
OUTPut	
[:STATe] .....	OFF
[SOURce]	
:FUNCTion	
[:SHAPE](?) .....	SQUare
:SCOPE	
[:SHAPE](?) .....	SQUare
:PARAMeter	
:SKEW .....	Inactive
:ALIGNment(?) .....	DEFault
[SOURce]	
:VOLTage	
[:LEVEl] .....	20mV
:FREQuency	
[:CW FIXed](?) .....	1kHz

All other settings remain unchanged.

*Final Width = 215mm*

BLANK PAGE (LEFT-HAND)

## Model 9500B — Emulation of Tektronix SG5030 and CG5010/5011

### 6.F.1 Summary

#### 6.F.1.1 Purpose

The purpose of bus emulation is to minimize reprogramming work in adapting the 9500B into situations where the user already has existing [SG5030/CG5010] systems or applications. Where the 9500B matches (or exceeds) the functional capability of the emulated instrument, then the command(s) are emulated.

#### 6.F.1.2 Basic Assumptions

The 9500B has two IEEE interfaces fitted. The emulation is 'bus only'. There is no attempt to emulate any manual mode operations. Once emulation mode is selected (via a configuration screen which allows individual bus addressing) the only manual operation available is to return to normal (9500B) mode. Because the emulation is intended for bus only, local operation in Manual mode is limited to 9500B operation. There is no ability to mix emulation and SCPI commands.

Each emulated instrument has an internal 'virtual state'. When a command is received for one of the instruments, its 'virtual state' will become the active state. In other words, the 9500B only exists as one instrument at a time.

The emulated instrument accepts parameter requests within the range of the 9500B, not the emulated instrument. For instance, a 9500B/400 variant will clearly not be able to generate 560 MHz as for a SG5030.

The application programmer may need to modify the application software in some way to deal with areas where emulation is not supported.

### 6.F.2 Command Compatibility

- The exact response format of the emulated instruments cannot be guaranteed.
- The low level command language is not emulated.
- The 9500B without Option 5 (5 full channels) has one signal channel and one trigger channel, matching the one signal and one trigger channel on the emulated instruments. With Option 5 fitted to the 9500B, 'signal' will use CH 1 and 'trigger' will use CH5.
- The terms NR1, NR2, NR3 and NRf appear within the following text and tables. These represent particular forms of 'Decimal Numeric Program Data' as described in the IEEE-488.2 Standard Specification. Briefly, they conform to the following criteria:
  - NR1: a number expressed as an integer only (no decimal point). '375' is in the form of NR1.
  - NR2: a number expressed as a 'mantissa', (i.e. can include a decimal point). '375.263' is in the form of NR2.
  - NR3: a number expressed as a 'mantissa' plus an 'exponent', separated by a white space (i.e. can include a decimal point, and also can include an exponent in the form of the ASCII character 'E' or 'e', followed by a power of 10). '375.263 E-3' is in the form of NR3.
  - NRf: This is a flexible form which accepts any of the three above forms. The spirit adopted in IEEE-488.2 is that a specific command which is transmitted over the bus should be consistent in its conformance to one of the three forms. On the other hand, a device which receives commands should be able to accept any of the three forms. This leads to the user-friendly concept of 'Precise Talker' and 'Forgiving Listener'.

## 6.F.3 Emulation Mode and Bus Address Selection

### 6.F.3.1 General

- Emulation mode and the appropriate bus address for CG5010/5011 or SG5030 are selected on a screen in Configuration mode.
- This sub-section introduces the actions necessary to perform these selections.

### 6.F.3.2 Configuration Mode

Before attempting to select Configuration mode, please refer to *Section 3, sub-section 3.4*, for information regarding Mode selection from the front panel. This sub-section also deals with the use of a password to open the screens which permit the Config. mode parameters to be changed.

To activate 5000-series calibrator emulation, it is necessary first to press the 'MORE' soft key, then use the Config. mode password to access the 'BUS ADDRESS' facility. Then the following screen will be displayed:

<b>Configuration</b>				BUS ADDRESS
Ser. No. XXXXXX		Rev. XXX		PRINTER
Options : 1.1 GHz		Normal xtal		POWER UP MODE
Present Settings:				
Ref frequency	50.0000 kHz	NEW PASSWRD		
Safety Voltage	100.000 V	EXT REF IN		
Bus Address	1	EXT REF OUT		
Printer	NONE	TODAY'S DATE      TIME		
Power-up mode	Manual			
Ext ref in	10 MHz			
Ext ref in	Disabled	EXIT		
REF FREQ	VOLTAGE LIMIT	DATE TIME	HEAD CONFIG	MORE

Pressing the BUS ADDRESS soft key presents the following screen:

<b>Configuration</b>				9500B
IEEE 488 ADDRESSES				5000 SERIES
9500B address= 22				
2nd address inactive				
Change by direct edit only.				
TODAY'S DATE      TIME				
EXIT				

### 6.F.3.3 Emulation Mode

On the IEEE 488 ADDRESSES screen, press the 5000 SERIES soft key.

<b>Configuration</b>				9500
IEEE 488 ADDRESSES				5000 SERIES
CG5011 (emul)	=	22		
SG5030 (emul)	=	Ø3		
Change by direct edit only.				
TODAY'S DATE      TIME				
EXIT				

Note that the 9500B contains two IEEE-488 interfaces, each of which will respond to a separate address. 9500B and CG5011 occupy one IEEE bus address and can be modified either on the 9500B screen or the 5000 series screen. SG5030 occupies the other bus address, which can be modified only on the 5000 series screen. The 5000 SERIES selection also switches the interface to accept the emulation commands only.

The small arrow under the '=' sign indicates which address will be changed when direct editing is used. The arrow is toggled between the two addresses using the (Tab) key.

The two emulation addresses cannot have the same number. Any attempt to write a duplicate address will result in an error message.

After setting the addresses, use EXIT to return to the Config mode 'Present settings' screen.

### 6.F.3.4 Points of Interest

- Addressing range is the standard 0 → 30.
- The message terminator can be either LF+EOI or just EOI.
- The IEEE-488 Interface Function Capability is the same as for the 9500B (SH1AH1T6L4SR1RL1PP0DC1DT0C0).



---

## 6.F.4 SG5030 Levelled Sine Generator

### 6.F.4.1 Command Equivalence

*Table 6.F.4.1 (overleaf)* lists the SG5030 commands (as outlined in the manual). The '9500B Emulation' column indicates whether the 9500B emulates the SG5030 command.

'X' indicates that the 9500B does not have an equivalent mapping. In this case the 9500B will accept the command and take no further action.

'+' indicates that the 9500B does not have an equivalent mapping, but the command is dealt with. For example, queries that report a 'standard' answer are mapped.

'√' indicates that the command is mapped.

### 6.F.4.2 Status and Error Reporting.

The Status Byte coding is the same as the SG5030, but the error numbers returned are those of the 9500B.

Refer to *Section 8, Appendix A*.

**Table 6.F.4.1 — SG5030 Command Emulation by 9500B**

SG5030 Command	SG5030 Command Description	9500B Emulation	9500B Response
ABStouch	Causes front-panel buttons or controls to be remotely activated.	X	
AMPLitude <NR3>[:dBm]	Sets the amplitude of the output signal in Volts (pk-pk) or dBm.	√	
Amplitude?	Queries the present amplitude setting.	√	AMPLITUDE <NR3>[:DBM]
CAL?	Queries the present DAC settings stored in NVRAM.	+	CAL 0,0,0,0,0,0,0,0,0,0,0,0
ERRor? EVEnt?	Queries information about the event reported in the most-recent serial poll. Note that these two commands are equivalent.	√	ERROR <9500B error number> EVENT <9500B error number>
EXTtb?	Queries the present state of the external time base.	√	EXTTB ACTIVE INACTIVE
FREQuency <NR3>	Sets the frequency of the output signal.	√	
FREQuency?	Queries the present frequency setting.	√	FREQUENCY <NR3>.
HELp?	Returns a list of all the command headers which the instrument accepts.	+	As SG5030.
ID?	Returns the instrument identification:	+	ID TEK/SG5030,V0.0,FX.XX
INIT	Clears the present settings and initialises the SG5030 to: 'Output off, 1V, 10MHz, Refreq off, RQS on, Userreq off'.	√	
LEVeled?	Returns the levelled signal status of the output.	+	LEVELED YES NO
OUTput ON OFF	Turns the signal on or off at the output head.	√	
OUTput?	Returns the present status of the output signal	√	OUTPUT ON OFF
RECall <NR3>	This command recalls the instrument settings from the non-volatile RAM store.	X	
REFreq ON OFF	Turns the reference 50kHz on or off.	√	
REFreq?	Queries the reference setting.	√	REFREQ ON OFF
RQS ON OFF	Enables or disables the ability of the instrument to generate Service Requests.	√	
RQS?	Queries whether the SRQ is enabled or disabled.	√	RQS ON OFF
SET?	Returns the present condition of various settings.	+	As SG5030.
STOre <num>	Store front panel settings.	X	
TEST	Performs instrument selftest. Failure is reported via the SRQ system.	X	
USEreq ON OFF	Enables or disables the ability to generate an SRQ by pressing the ID button on the front panel.	X	
USEreq?	Returns the present status of the instrument ID SRQ.	+	USEREQ OFF

## 6.F.5 CG5010/5011 Programmable Calibrator

### 6.F.5.1 Command Equivalence

Table 6.F.5.1 (below and overleaf) lists the CG5010 commands (as outlined in the manual). The '9500B Emulation' column indicates whether the 9500B emulates the CG5010 command.

'X' indicates that the 9500B does not have an equivalent mapping. In this case the 9500B will accept the command and take no further action.

'+' indicates that the 9500B does not have an equivalent mapping, but the command is dealt with. For example, queries that report a 'standard' answer are mapped.

'√' indicates that the command is mapped.

### 6.F.5.2 Status and Error Reporting.

The Status Byte coding is the same as the CG5010/5011, but the error numbers returned are those of the 9500B.

Refer to Section 8, Appendix A.

**Table 6.F.5.1 — CG5010/5011 Command Emulation by 9500B**

CG5010/5011 Command	CG5010/5011 Command Description	9500B Emulation	9500B Response
A/D <NR3>A	Sets mode to Current and sets units per division.	√	
CALDATE <mm>-<dd>-<yy>	Sets the calibration date.	√	
CALDATE?	Returns calibration date information	√	<mm>-<dd>-<yy>
CHOP ON OFF	For amplitude modes only. OFF sets output signal level to the DC value of the amplitude set. ON restores normal amplitude frequency output.	X	
COMP CG DUT AUTO	CG = Comparator head to CG5010 output, DUT = Comparator head to DUT AUTO = Chop between CG5010 output and DUT	X	
CS ON OFF	Sets or clears Slewed Edge — used only in CG5010 calibration.	X	
CSET?	Returns <message unit> for changed settings information to the controller.	+	CSET NONE
DEC	Subtracts 0.1 from present percent error readout for HIGH or FAST indications, or adds 0.1 for LOW or SLOW indications.	+	
DLY ON OFF	Sets delayed trigger for FAST EDGE mode.	X	
DSP	Enable or disable variable display for EDGE or FAST EDGE modes.	X	
DSPL?	Returns <message unit> for present units/division and percent error information.	√	PCT -0.5;U/D 1.0E+0 If VARIABLE is not on, then PCT has the value of 0.0.
DT ON OFF	Changes status of DT0/DT1 mode of bus — allows use of GET.	X	
EDGE <NR1>	Sets number of edges generated for one slewing cycle.	X	
ERR?	Returns a code for the error condition.	√	ERR <9500B error number>

**Table 6.F.5.1 — CG5010/5011 Command Emulation by 9500B (Contd.)**

CG5010/5011 Command	CG5010/5011 Command Description	9500B Emulation	9500B Response
FREQ DC <NR3>	DC = Sets chop frequency to DC; <NR3> = Sets chop frequency from 10Hz to 1MHz.	√	
FXD	Removes the VARIABLE (deviation) value from the output value.	√	
HOLD <NR1>	For SLEWED EDGE mode.	X	
ID?	Returns identity of instrument.	+	ID TEK/SG5011,V0.0,FX.XX
INC	Adds 0.1 from present DUT error readout for HIGH or FAST indications, or subtracts 0.1 for LOW or SLOW indications.	√	
INIT	Clears the present settings and initialises to defaults: Volts, 1V/D, 1kHz, 1 division, output off, trigger norm, off.	√	
LDZ 50 HI	50 = Selects 50Ω termination; HI = Selects high impedance termination.	√	
LOOP ON OFF	Selects or deselects current loop,	X	
LSHF	Decrements the shift counter by 1.	X	
MAG X1 X10	Sets time/division magnifier to X1 or X10 for Markers.	√	
MASK 1 2 3	Masks errors so that SRQ is not sent.	X	
MODE V VOLTAGE	Selects VOLTS	√	
MODE CUR CURRENT	Selects CURRENT mode	√	
MODE EDGE	Selects EDGE	√	
MODE FE FASTEDGE	Selects FAST EDGE	√	
MODE MKRS MARKERS	Selects TIMING MARKERS	√	
MODE SLWD SLEWED	Selects SLEWED EDGE	X	
MULT <NRF>	Sets Number of Divisions multiplier in range 1-10.	√	
NEG	Sets negative EDGE and VOLTAGE polarity.	√	
NM ON OFF	Sets Narrow Markers mode.	X	
OPC ON OFF	Controls generation of SRQ for operation complete when CONTINUE is pressed.	X	
OUT ON OFF	Sets main output ON or OFF.	√	
PCT <NR2>	Sets DUT percent error readout.	√	
PCT?	Returns <message unit> present DUT percentage error information.	√	PCT 2.0; (if PCT selected), or PCT 0.0; if not.
POS	Sets positive EDGE polarity. POS is accepted in AC Volts with no error (NEG gives a 22 error number).	√	
READ?	Returns <message unit> units/division and DUT percentage error after operator pressed the CONTINUE key.	X	
REM ON OFF	Controls generation of SRQ when ID button is pressed.	X	

**Table 6.F.5.1 — CG5010/5011 Command Emulation by 9500B (Contd.)**

CG5010/5011 Command	CG5010/5011 Command Description	9500B Emulation	9500B Response
RPT?	Repeats the most-recent message sent.	√	
RQS ON OFF	Turns on or off the SRQ generations.	√	
RSHF	Increments the shift counter by 1.	X	
SET?	Returns settings of instrument in settings-dependent format.	+	As CG5011
S/D <NR3>S	Sets Markers mode, if not already selected, and then sets the seconds per division value.	√	
SHIFT <NR1>	Sets shift counter argument.	X	
SRQ?	Returns the reason for SRQ.	X	
TEST	Activates the instrument power-on selftest routine (takes about 5 secs).	X	
TRIG ON OFF NORM X.1 X.01	ON = Turns TRIGGER OUTPUT on. OFF = Turns TRIGGER OUTPUT off. NORM = Sets trigger rate to the same as the output signal rate (Power-on default). X.1 = Sets trigger rate to 1/10 of the output signal rate. X.01 = Sets trigger rate to 1/100 of the output signal rate.	√ √ √ √ √	
TSET?	Returns the ASCII word 'NULL' message.	X	
U/D <NR3>	Sets the desired units per division.	√	
U/D?	Returns the present <NR3> units per division.	√	U/D <NR3>
UMSK <NR1>	Unmasks an error that was masked, opposite to the MASK command.	X	
VAR	Sets instrument to display DUT percent error readout.	√	
VERS?	Returns a version ID code.	+	VERS 0000FFFF
V/D <NR3>V	Sets the instrument to voltage and desired number of units/division.	√	
ZSHF	Resets the shift counter to zero.	X	

BLANK PAGE (LEFT-HAND)

# SECTION 7 9500B SPECIFICATIONS

## 7.1 General

### 7.1.1 Environmental

Environmental	Operating	Storage
Temperature:	5°C to 40°C	0°C to 50°C Transit <100hrs -20°C to 60°C
Humidity: (non-condensing)	<90% 5°C to 30°C <75% 30°C to 40°C	<95% 0°C to 50°C
Water Ingress	IP65	
Altitude:	<2000m, 6500ft	<12000m, 40000ft
Safety	Designed to and documented to EN61010-1-1:1993/A2:1995. CE and ETL marked	
EMC (including options)		
Radiated Emissions	EN55011/22 FCC Rules part 15 sub-part J class B	
Radiated Immunity	EN50082-1	
Conducted Emissions	EN55011 1991 Class B	
Conducted Immunity	EN50082-1	
Harmonics	EN61000-3-2	
Shock and Vibration	MIL-T-28800 type III class 5, style E.	
Pollution Degree	2	
Line Voltage	95V to 132V rms 209V to 264V rms Installation Cat II	
Line Frequency	48Hz to 63Hz	
Power Consumption	<400 VA	
Line Fuse: 20mm IEC127	220/240V T5.0A 250V 100/120V T10.0A 250V	
Warm-up:	20 minutes	

### 7.1.2 Dimensions

	9500B Base Unit	95xx Active Head
Dimensions:	H x W x D 133 x 427 x 440 mm 5.24 x 16.8 x 17.3 ins	H x W x D 65 x 31 x 140 mm 2.56 x 1.22 x 5.51 ins
Weight:	12 kg (27 lbs) approx.	0.45 kg (1 lb) . approx
Warranty Period:	1-year	3-year Active Plus CarePlan

## 7.2 Accuracy Specifications

All Specifications apply at TCal  $\pm 5^\circ\text{C}$ , where Factory TCal =  $23^\circ\text{C}$ . Uncertainty includes long-term stability of 1yr (5yrs for frequency), temperature coefficient, linearity, load and line regulation and the traceability of factory and National calibration standards. In general, nothing further needs to be added to determine the Test Uncertainty Ratio over the instrument under calibration.

*Final Width = 215mm*





## 7.4 Edge Function Specification

### 7.4.1 Edge Function (9550 Active Head supports 25ps Fast Edge only)

	500ps Edge (9510/30 Heads Only) Into 50Ω or 1MΩ	HV Edge Into 1MΩ	150ps Fast Edge (9530 Head Only) Into 50Ω	70ps Fast Edge (9560 Head Only) Into 50Ω	25ps Fast Edge (9550 Head Only) Into 50Ω
Rise/Fall Time (10%-90%):	500ps	<100Vpk-pk <150ns ≥100Vpk-pk <200ns NB into 50Ω <100ns	150ps	70ps	25ps
Accuracy:	+50ps to -150ps	NA	±25ps	±12ps	±3ps
Accuracy : (displayed value)	±35ps	NA	±12ps	±8ps	±1.5ps
Polarity:	Rising or Falling Return to Ground	Rising or Falling	Rising or Falling Return to Ground	Rising Return to Ground	Rising or Falling Return to Ground
Amplitude:	5mV to 3V pk-pk	1mV to 200V pk-pk NB 1mV to 5V pk-pk into 50Ω	5mV to 3V pk-pk	25mV to 2V pk-pk	425 to 575mV pk-pk
Amplitude Accuracy:	±2%				
Ranging:	Volt/div factors of 1, 2, 5 or 1, 2, 2.5, 4, 5; or continuously variable				continuous
Deviation:	±11.2% (Including over and under-range)				NA
Duty Cycle:	10%	50%	10%	10%	10%
Aberrations: (Into VSWR 1.2:1)	<±2% pk in 8GHz [1] <±1.5% pk in 3GHz (first 10ns)	<±2% pk (first 500ns)	<±3% pk in 8GHz [1] <±2% pk in 3GHz (first 1ns)	<±4% pk in 20GHz <±3% pk in 8GHz <±1% pk in 3GHz (first 700ps)	<±5% pk in 20GHz <±3% pk in 10GHz <±1% pk in 3GHz (first 200ps)
Extended Aberrations:	<±0.5% pk 10 ns to 1μs	<±0.1% pk 500ns to 100ms	<±1% pk 1ns to 10ns	<±1% pk 700ps to 10ns	<±1% pk 200ps to 10ns
	<0.1% pk beyond 1μs	<0.01% pk beyond 100ms	<0.5% pk beyond 10ns	<0.5% pk beyond 10ns	<0.1% pk beyond 10ns
Reflection Absorption:	>-30dB	NA		>-30dB	
Frequency:	10Hz to 2MHz	10Hz to 100kHz	10Hz to 2MHz	10Hz to 1MHz	10Hz to 1MHz
Frequency Accuracy:	±0.25ppm				
Trigger to Edge delay:	25ns (typical)				
Trigger to Edge jitter:	<5ps pk-pk (typical)				

*Final Width = 215mm*

[1] For Edge amplitudes below 33mV, this specification applies in a 3GHz bandwidth.  
Edge speeds faster than 500ps are not recommended for 1MΩ input applications.  
The 9560 Head is restricted to 50Ω loads only.

## 7.5 Timing Marker Function Specification

### 7.5.1 Timing Marker ((Not available via 9550 Active Head))

Styles:	Square	Pulse	Narrow Triangle	Sine (extension of Square)
Period	9.0091ns to 55s	900.91ns to 55s	900.91ns to 55s	450.5ps to 9.009ns for 9500B/1100 or 9500B/3200 909.1ps to 9.009ns for 9500B/600 180.19ps to 9.009ns for 9500B/3200 with 9560 Head
Ranging:	Time/div ranging 1, 2, 5 or 1, 2, 2.5, 4, 5 or continuously variable			
Period Deviation Range:			±45%	
Rise/fall Times:	1ns typ..	1ns typ.	2.5% of period	NA
Timing Accuracy:			±0.25ppm	
Timing Jitter: (within time window)			<10ps pk-pk (<100ns) <100ps pk-pk (<100us) <1000ps pk-pk (<10ms)	
Duty Cycle:	50%	5%	5%	NA
Amplitude:	100mV, 250mV, 500mV and 1V pk-pk symmetrical about ground NB 9500B/1100, 500mV pk-pk max for period <1ns			
Subdivision:	Every 10th marker can be set to higher amplitude			NA

*Final Width = 215mm*

Line frequency timing markers are available in the Square Wave function.

Jitter wrt Line zero crossing: <±20us pk-pk.

Frequencies above 500MHz are not recommended for 1MΩ input applications.

The 9560 Head is restricted to 50Ω loads only.

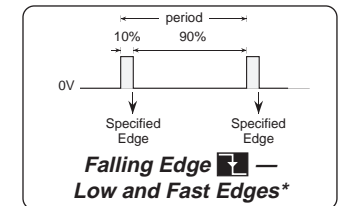
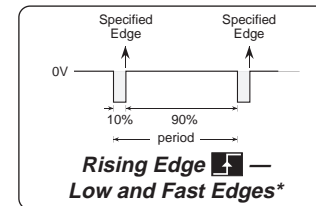

\* = For High Edge, the Duty Cycle is different, but the specified edges correspond to those shown above.

## 7.6 Levelled Sine Function Specification

### 7.6.1 Levelled Sine Function ((Not available via 9550 Active Head))

	9500B/600	9500B/1100	9500B/3200 with 9530 Head	9500B/3200 with 9560 Head
Frequency Range:	0.1 Hz to 600 MHz	0.1 Hz to 1.1 GHz	0.1 Hz to 3.2 GHz	0.1 Hz to 6.4 GHz
Frequency Uncertainty:	≥12kHz ±0.25ppm, <12kHz ±3ppm			
Amplitude (pk-pk): (into 50Ω)	0.1Hz - 550MHz: 5mV to 5V	0.1Hz to 550MHz: 5mV to 5V	0.1Hz to 550MHz: 5mV to 5V	0.1Hz to 550MHz: 5mV to 5V
	550MHz-600MHz: 5mV to 3V	550MHz to 1.1GHz: 5mV to 3V	550MHz to 2.5GHz: 5mV to 3V	550MHz to 2.5GHz: 5mV to 3V
			2.5GHz to 3.2GHz: 5mV to 2V	2.5GHz to 3.2GHz: 5mV to 2V
				3.2GHz to 6.4GHz: 25mV to 2V
Amplitude Accuracy:	±1.5% at single Ref Frequency (50 kHz - 10MHz)			
Flatness wrt Ref Freq: Into VSWR of 1.6:1 (1.2:1)	0.1Hz to 300MHz :±2.0%	0.1Hz to 300MHz: :±2.0%	0.1Hz to 300MHz: :±2.0%	0.1Hz to 300MHz: :±2.0%
	300MHz to 550MHz: ±3% (±2.5%)	300MHz to 550MHz: ±3% (±2.5%)	300MHz to 550MHz: ±3% (±2.5%)	300MHz to 550MHz: ±2.5% (±2.5%)
	550MHz to 600MHz: ±4% (±3.5%)	550MHz to 1.1GHz: ±4% (±3.5%)	550MHz to 1.1GHz: ±4% (±3.5%)	550MHz to 3.0GHz: ±3.5% (±3.0%)
			1.1GHz to 3.2GHz: ±5.0% (±4.0%)	3.0GHz to 6.0GHz: ±5.0% (±4.0%)
Source VSWR:(typical)	<1.2:1	<1.2:1	<1.5GHz: <1.2:1	<550MHz: <1.1:1
			1.5GHz to 3.2GHz: <1.35:1	550MHz to 3.0GHz: <1.2:1
				3.0GHz to 6.0GHz: <1.35:1
Amplitude Ranging:	Volts/div ranging 1, 2, 5 or 1, 2, 2.5, 4, 5 or continuously variable			
Deviation:	±11.2% (Including over and under-range)			
Harmonic Purity:	2nd Harmonic <-35dBc; 3rd Harmonic <-40dBc in 12GHz			
Non & Sub Harm' Purity:	<-40dBc			<6.0GHz: <-35dBc

*Final Width = 215mm*

Frequencies above 500MHz are not recommended for 1M input applications.  
The 9560 Head is restricted to 50Ω loads only.

## 7.7 Dual Sine Function Specification

### 7.7.1 Levelled Sine Function (Selected heads must be of the same type, either 9510, 9530 or 9560)

	9500B/600	9500B/1100	9500B/3200 & 9530	9500B/3200 & 9560
Frequency Range:	0.1 Hz to 600 MHz	0.1 Hz to 1.1 GHz	0.1 Hz to 3.2 GHz	0.1 Hz to 3.2 GHz
Time Alignment:	±25ps Any Channel to Any Channel			
Amplitude (pk-pk): (into 50Ω)	0.1Hz to 550MHz: 5mV to 2.5V	0.1Hz to 550MHz: 5mV to 2.5V	0.1Hz to 550MHz: 5mV to 2.5V	0.1Hz to 550MHz: 5mV to 2.5V
	550MHz to 600MHz: 5mV to 1.5V	550MHz to 1.1GHz: 5mV to 1.5V	550MHz to 2.5GHz: 5mV to 1.5V	550MHz to 2.5GHz: 5mV to 1.5V
			2.5GHz to 3.2GHz: 5mV to 1V	2.5GHz to 3.2GHz: 5mV to 1V
Accuracy and Flatness: (Master Channel)	As Levelled Sine above			
Flatness wrt Ref Freq: (Slave Channel)	0.1Hz to 600MHz: ±10%	0.1Hz to 750MHz: ±10%	0.1Hz to 750MHz: ±10%	0.1Hz to 1GHz: ±10%
		750MHz to 1.1GHz: ±30%	750MHz to 1.1GHz: ±30%	1GHz to 3.2GHz: ±25%

*Final Width = 215mm*

Frequencies above 500MHz are not recommended for 1MΩ input applications.  
The 9560 Head is restricted to 50Ω loads only.

### 7.7.2 Input Impedance Functions (Not available via 9550 Active Head)

Resistance Measurement:	10Ω - 40Ω	40Ω - 90Ω	90Ω - 150Ω	50kΩ - 800kΩ	800kΩ - 1.2MΩ	1.2MΩ - 12MΩ
Accuracy:	±0.5%	±0.1%	±0.5%	±0.5%	±0.1%	±0.5%

(Not available via 9550 or 9560 Active Head)

Capacitance Measurement:	1pF to 35pF	35pF to 95pF
Accuracy:	±2% ±0.25pF	±3% ±0.25pF

---

## 7.8 Pulse Width Function Specification

### 7.8.1 Pulse Width Function (Not available via 9550 Active Head)

Pulse Width:	1n to 100ns
Accuracy:	< ±5% ±200ps
Adjustment Resolution:	1ns to 4ns, <50ps 4ns to 20ns <250ps 20ns to 100ns <1ns
Rise and Fall Time:	450ps (typical)
Aberrations:	< ±5% pk (typical)
Width Stability:	< 10ps pk-pk 10mins/1°C
Pulse Jitter: (wrt Trigger)	< 5ps pk-pk
Frequency:	1kHz to 1MHz
Amplitude:	1V pk-pk into 50Ω

*Final Width = 215mm*

## 7.9 Other Output function Specifications

### 7.9.1 Current Function (Not available via 9550 Active Head)

Current	DC	Squarewave
Amplitude:	$\pm 100\mu\text{A}$ to $\pm 100\text{mA}$	$\pm 100\mu\text{A}$ to $\pm 100\text{mA}$ pk-pk
Accuracy :	$\pm(0.25\% + 0.5\mu\text{A})$	$\pm(0.25\% + 0.5\mu\text{A})$ @ 1kHz
Ranging:	Amps/div ranging 1, 2, 5 or 1, 2, 2.5, 4, 5 or continuously variable	
Frequency:		10Hz to 100kHz
Duty Cycle & Symmetry:		50%, symmetrical about ground
Rise Time and Aberrations		<150ns and $\leq \pm 2\%$ pk

Requires 9530 or 9510 Head and BNC Current adaptor

### 7.9.2 Video Output

Composite Video Output	
Amplitude:	1.0Vpk-pk
Pattern: (Full Raster)	White, Grey or Black
Sync Polarity:	Positive or Negative
Standards:	625-line 50Hz 525-line 60Hz
Trigger Output:	Composite Sync or Odd Field start

9560 50 $\Omega$  only

### 7.9.4 Overload Pulse

Overload Pulse	
Amplitude:	5V to 20V into 50 $\Omega$
Polarity:	Positive / Negative
Duration:	0.2s to 100s (subject to pulse energy limits)
Energy: Power in 50:	1.6J to 50J 0.5W to 8W
Trigger:	Manual Max Rep Rate 0.3Hz (Internally Limited)

### 7.9.3 LF Linear Ramp

LF Linear Ramp	
Waveforms:	1V pk-pk triangle symmetrical about ground
Linearity:	$\leq \pm 0.1\%$ deviation over 10 - 90%
Ramp Time:	1ms, 10ms, 100ms or 1s

The 9560 Head is restricted to 50 $\Omega$  loads only.

### 7.9.5 Zero Skew

Zero Skew	
Unadjusted Skew:	$\leq \pm 50\text{ps}$ ch to ch
Adjusted Skew:	$\leq \pm 5\text{ps}$ ch to ch
Skew Temp Coef	$< 0.2\text{ps}/^\circ\text{C}$
Rise and Fall Time	450ps (typical)
Relative Jitter	$< 7\text{ps}$ pk-pk

*Final Width = 215mm*

### 7.9.6 Input Leakage

Input Leakage Function	
Open Circuit Output	Leakage < $\pm 50\text{pA}$
Short Circuit Output	Offset < $\pm 15\mu\text{V}$

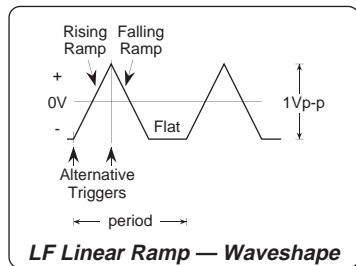

### 7.9.7 Auxiliary Input

Auxiliary Input	
Signal Routing:	Rear SMA input, passive and switched 50Ω path to any Active Head
Maximum Input:	$\pm 40\text{V}$ pk-pk, $\pm 400\text{mA}$ pk-pk
Switching Break and Make Capacity	$\pm 5\text{V}$ pk-pk, $\pm 100\text{mA}$ pk-pk
VSWR	<1.2:1 typ to 1.1GHz
Insertion Loss (Into 50Ω)	to 100MHz <2.5dB, to 500MHz <4dB, to 1GHz <6dB

*Final Width = 215mm*

### 7.9.8 Reference Frequency

Reference Frequency	Input (BNC)	Output (BNC)
Frequency Range:	1MHz to 20MHz in 1MHz steps	1MHz or 10MHz
Level: (typical)	90mV - 1V pk-pk	Into 50Ω: 1V pk-pk Into 1MΩ: 2V pk-pk
Lock Range:	$\pm 50\text{ppm}$	

## 7.10 Trigger Output Specifications

### 7.10.1 Input Leakage (Not available via 9550 Active Head)

Function	Signal	Trigger Waveform	Trigger Frequency	Trigger Alignment	Trigger Leads by
Voltage	DC	Square	100Hz		
	Square	Square	Signal div 1/10/100	Depart from ground	1/64 Period
Levelled Sine	<100MHz	Square	Signal	Rising Zero Cross	
	>100MHz	Square	Signal div 1/10/100	Rising Zero Cross	
	>3.2GHz	Square	Signal div 2/20/200	Rising Zero Cross	
Edge	500ps	1:9 Pulse	Signal div 1/10/100	Return to Ground	25ns
	HV	Square	Signal div 1/10/100	Depart from ground	1/64 Period
	150ps	1:9 Pulse	Signal div 1/10/100	Return to Ground	25ns
	25ps	1:9 Pulse	Signal div 1/10/100	Return to Ground	25ns
	70ps	1:9 Pulse	Signal div 1/10/100	Return to Ground	25ns
Timing Markers (>10ns)	Normal	1:19 Pulse	Signal div 1/10/100	Rising Edge or Triangle Peak	
	Highlighted	1:199 Pulse	Signal div 1/10/100	Rising Edge or Triangle Peak	
Current	DC	Square	100Hz		
	Square	Square	Signal div 1/10/100	Depart from ground	1/64 Period
Composite Video	Line	Composite Sync	Line Freq	Sync lead edge	
	Field	Pulse	Frame Freq	Frame start	
Linear Ramp		1:2 Pulse	Signal div 1/10/100	Start of rise or fall	
Overload Pulse		Step or Square	Single or 100Hz	Lead Edge	

*Final Width = 215mm*

Input Leakage, Auxiliary Input and Input Impedance functions have no related trigger output. Free running 100Hz signal provided  
No trigger provided in Pulse Width function

Amplitude:	1Vpk-pk into 50Ω
Rise and Fall Time:	< 1ns
Aberrations:	< ±10%
Source VSWR:	1.2:1 typ



---

## Section 8 Model 9500B — Routine Maintenance and Test

### 8.1 About Section 8

Section 8 gives first-level procedures for maintaining a Model 9500B, performing the Selftest operations and dealing with their results. We shall recommend maintenance intervals, methods and parts, and detail the routine maintenance procedures. Section 8 is divided into the following sub-sections:

8.2	Routine Maintenance.	2	8.3	Model 9500B Test and Selftest	4	8.4	Printing Selftest Results	10
8.2.1	General Cleaning .....	8-2	8.3.1	Types of Test .....	8-4	8.4.1	Introduction .....	8-10
8.2.2	Air Intake Filter — Description and Maintenance Intervals .....	8-2	8.3.1.1	Entry to Test Mode .....	8-4	8.4.2	Parallel Port .....	8-10
8.2.2.1	Removing the Top Cover .....	8-2	8.3.2	Base, Heads, All and Fast Selftests .....	8-4	8.4.3	Printing Setup .....	8-11
8.2.2.2	Top Guard Shield and Calibration Seal — Caution! .....	8-2	8.3.2.1	Aborting the Selftest .....	8-4	8.4.3.1	Printer Type .....	8-11
8.2.2.3	Removing the Filter Element .....	8-2	8.3.2.2	Selftest Runs to Completion .....	8-5	8.4.3.2	Data Formatting .....	8-11
8.2.2.4	Cleaning the Filter Element .....	8-2	8.3.2.3	Viewing the Test Results .....	8-5	8.4.4	Results Printout .....	8-11
8.2.2.5	Refitting the Filter Element .....	8-2	8.3.2.4	Printing the Test Results .....	8-5			
8.2.2.6	Refitting the Top Cover .....	8-2	8.3.3	Selftest at Power-On .....	8-6	<b>Appendix A:</b>	Error Reporting Subsystem.	
8.2.2.7	Replacement Parts .....	8-2	8.3.4	Interface Test .....	8-6			
8.2.3	Firmware Upgrade .....	8-3	8.3.4.1	Access to Interface Tests .....	8-6			
8.2.3.1	Introduction .....	8-3	8.3.4.2	Display Memory Checks .....	8-6			
8.2.3.2	Procedure .....	8-3	8.3.4.3	Keyboard Checks .....	8-7			
			8.3.4.4	Display Checks .....	8-7			
			8.3.4.5	Memory Card Checks .....	8-8			
			8.3.4.6	Tracker Ball Checks .....	8-9			
			8.3.4.7	Printer Checks .....	8-9			

*Final Width = 215mm*

## 8.2 Routine Maintenance

### 8.2.1 General Cleaning

**WARNING** *Disconnect the power line cord before cleaning - see the Safety Issues section at the front of this manual.*



Remove dust from the top cover using a soft brush (do not use a cloth unless it is lint-free). Keep the controls clean using a soft, lint-free cloth, dampened with a non-toxic, non-corrosive detergent. The display screen should be cleaned using a soft, lint-free cloth, dampened with an anti-static cleanser. Avoid extreme pressure on the face of the screen and do not spray the screen directly.

### 8.2.2 Air Intake Filter

**WARNING** *Disconnect the power line cord before removing any covers - see the Safety Issues section at the front of this manual.*



The internal airflow is powered by an axial fan which draws cooling air through the interior (directed mainly through the RF module) to be exhausted on the left side via holes in the cover. Replacement air is drawn into the instrument through holes in the right side of the top cover, then through a 20ppi (pores per inch) reticulated filter. This filter is accessed by removing the top cover.

Once the cover is removed, holes can be seen in the chassis assembly right side, with the reticulated filter located over these holes, attached by four black nylon snap rivets through four holes to the chassis assembly.

*Inspect and clean the filter element by vacuuming at intervals of no more than 90 days. Remove the filter for thorough cleaning at least once per year, immediately prior to routine calibration of the unit.*

**8.2.2.1 Removing the Top Cover**  
**WARNING** *Disconnect the power line cord before removing any covers - see the Safety Issues section at the front of this manual.*



The side edges of the top cover are located in slots in both side extrusions, and secured to the rear panel by two screws. A solid plastic block protects each of the rear corners.

To access the filter element, remove the top cover as follows:

1. Release the four screws securing the two rear-corner blocks and remove the blocks.
2. Release the two screws securing the top cover to the rear panel.
3. Pull the top cover to the rear to clear the front bezel, then lift off to the rear.

### 8.2.2.2 Top Guard Shield and Calibration Seal

#### IMPORTANT!

1. With the cover removed, a 'Calibration seal' can be seen covering a countersunk screwhead on the front of the top guard shield. The seal is set in position following a calibration of the instrument, so that removal of the guard shield can be detected. The calibration seal must **NOT** be broken unless the guard shield is to be removed for **Authorized** work inside the chassis assembly.
2. **Removal of the guard shield will compromise the traceable calibration of the instrument, and a full recalibration of the 9500B will be required.**

*If removal of the guard shield is authorized, take care to heed the **SAFETY WARNING** printed on it next to the symbol.*

### 8.2.2.3 Removing the Filter Element

The filter is removed as follows: Carefully lever out the center pin of each of the four black nylon snap rivets and pull out the snap latches. Lift off the filter element.

### 8.2.2.4 Cleaning the Filter Element

Once the filter is removed, wash it in warm water and household detergent, rinse thoroughly and allow to dry.

### 8.2.2.5 Refitting the Filter Element

1. Hold the filter element in position to cover the chassis holes, and the four securing holes. Separate the latch and center pin of a black nylon snap rivet, and push the latch through the filter into a securing hole at the top. Fit the center pin into the latch and push fully home, so that the pin opens the splits in the rear of the latch.
2. *Slightly* stretch the filter element into the correct position; fit and secure the other four snap rivets.

### 8.2.2.6 Refitting the Top Cover

Carefully refit the top cover into the slots in the side extrusions, with the front edge immediately behind the front bezel; push forward to locate inside the bezel, and secure to the rear panel using the two screws. Refit and secure the corner blocks.

### 8.2.2.7 Replacement Parts

Should the filter or snap rivets become damaged by removal or refitting, the following parts can be ordered through your Fluke Sales and Service Center:

Part No.	Description	Manufacturer	Type	Qty
451004	20ppi Reticulated Foam Filter	-----	-----	1
617020	Snap Rivet, Black Nylon	Richco.	SR4050B	5

Final Width = 215mm

## 8.2.3 Firmware Upgrade

### 8.2.3.1 Introduction

The Model 9500B firmware can be upgraded using a 'Personal Computer Memory Card Interface Adaptor' (PC-Card). To do this, the Model 9500B has been fitted with FLASH memory chips to provide the update capability. If an upgrade is required for your Model 9500B unit(s), your Service Center will inform you and provide the appropriate PC-Card.

This Sub-Section describes the routine procedure for upgrading the firmware. Note that the 'All' Self Test appears *twice* in the procedure: before and after carrying out the upgrade. This is included on two occasions to determine whether any difficulties were present before the upgrade, or whether they have arisen as a result of the upgrade.

### 8.2.3.2 Procedure

#### 1. 'All' Self Test (Refer to paras 8.3.1 & 8.3.2):

Execute a 'All' Self Test and record any errors. If printing facilities are available, select the **PRINT** option to obtain a hard copy of the results.

#### 2. Prepare the 9500B:

- Switch 9500B Power **OFF**.
- Locate the **FACTORY SET** switches on the 9500B rear panel:

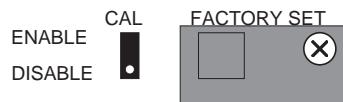

- Remove the switch cover by releasing its retaining screw.



- Set **Switch 6** to the **ENABLE** position (up) Do not disturb any of the other switches.

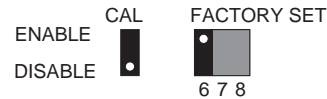

#### 3. Insert the PC-Card:

- Locate '**PCMCIA SLOT 1**' in the 9500B front panel.
- Insert the PC-Card into '**PCMCIA SLOT 1**', exerting just enough pressure to push out the black button by the side of the slot.

#### 4. Re-Program the Firmware:

- Switch 9500B Power **ON**.
- Observe the following growth pattern on the 9500B LCD display:



The process takes approximately 2 minutes to complete. When complete, a repetitive, pulsed audible tone will be heard.

If for any reason a continuous audible tone is heard, the update has not been successful. Note the current state of the growth pattern on the display, and relay this information back to the Service Center.

#### 5. Recover the Operational State of the 9500B:

- Switch 9500B Power **OFF**.
- Return **Switch 6** to the **DISABLE** position. Do not disturb any of the other switches.
- Replace and secure the switch cover.
- Remove the PC-Card, switch the 9500B Power **ON** and wait for approximately 40 seconds until the Power-On Selftest is complete.
- On the right of the 9500B front panel, press the **Mode** key.
- At the bottom of the 9500B LCD display, press the soft **CONFIG** key, and check that the firmware issue, shown on the screen, matches that on the PC-Card.
- Transfer back to the Mode Selection screen by pressing the **Mode** key.

#### 6. 'All' Self Test (Refer to paras 8.3.1 & 8.3.2):

- Execute an 'All' Self Test and record any errors. If printing facilities are available, select the **PRINT** option to obtain a hard copy of the results (*refer also to paras 8.4*).
- Note any differences between the self tests at items 1 and 6.
- Report the results of the upgrade procedure back to the Service Center.

The Model 9500B firmware upgrade is now complete. Please return your PCMCIA to the Service Center.

*Final Width = 215mm*

## 8.3 Model 9500B Test and Selftest

### 8.3.1 Types of Test

There are four main types of selftest, 'Base', 'Heads', 'All' and 'Fast'. The Fast selftest is also performed automatically at power-on. In addition, the interface for front panel operation can be selectively tested, covering such areas as display memory integrity, keyboard operation, the display itself, integrity and formatting of static RAM memory cards for Procedure mode, the correct operation of a connected tracker-ball, and the correct operation of a connected printer. These tests are detailed in the following paragraphs:

**Please Note that all Heads should be disconnected from the UUT Oscilloscope before initiating a Self Test. Failure to disconnect may result in failed tests.**

#### 8.3.1.1 Entry to Test Mode

Test mode is selected from the Mode Selection menu, which is displayed by pressing the front panel 'Mode' key, highlighted in Fig 8.3.1:

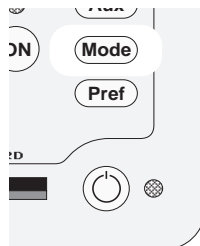
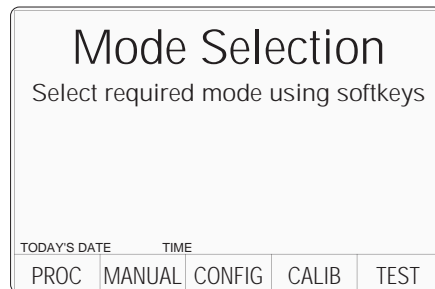

Fig. 8.3.1 'Mode' Key

The Mode key sets up a special menu display, offering selection from five primary modes:



This menu can be exited **only** by pressing one of the five screen keys.

#### TEST

This key enters Test mode, displaying the following screen:

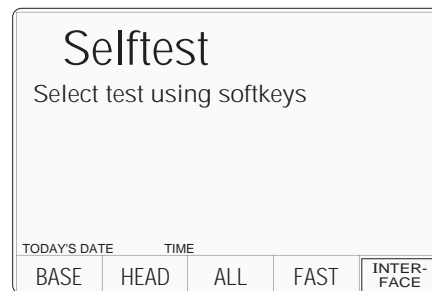

**BASE** runs a selftest of the Base Unit.

**HEADS** runs a selftest of all fitted Active Heads.

**ALL** runs a selftest of the Base Unit and all fitted Active Heads.

**FAST** runs the same confidence selftest as at Power On.

#### INTERFACE

This key allows checks of the display and display memory, the front panel keyboard, the (Procedure mode) memory card slots, the tracker ball and printer interfaces.

### 8.3.2 Base, Heads, All and Fast Selftest

**BASE, HEADS, ALL** and **FAST** selftests follow the same format. By pressing one of these four screen keys on the 'Select test' menu screen, the 9500B runs that selftest. The first screen shows the type of test, the pathway under test and the number of tests remaining. For example:

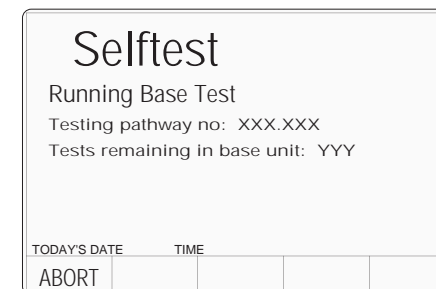

*(In the following descriptions, it is assumed that a BASE selftest was selected. Other selftests have the selftest name appearing on the screen).*

#### 8.3.2.1 Aborting the Selftest

**ABORT** stops the selftest and displays the appropriate 'ABORTED' screen. For example:

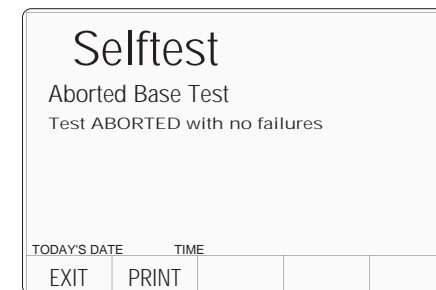

If there were no failures up to the point of aborting, this is shown on the screen.

**EXIT** returns to the 'Select test' menu screen.

**PRINT** prints out the results of the test, up to the point of aborting. Refer to *Sub-section 8.4*.

If failures were encountered up to the point of aborting, EXIT and PRINT are available. Also, the number of failures is shown on the screen, and an extra selection will be available:

Final Width = 215mm

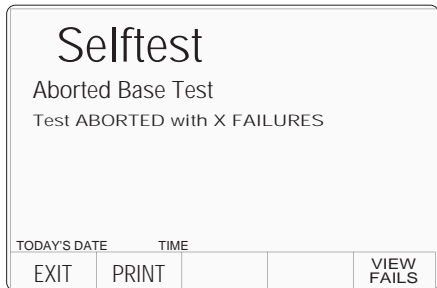

### VIEW FAILS

sets up a special screen for detailing the parameters of the failures encountered (described later in Paras 8.3.2.3).

#### 8.3.2.2 Selftest Runs to Completion

If the selftest is not aborted, it will run to completion, and if the test is successful with no failures, a screen will appear:



If failures were encountered during the test, the 9500B will display a completion screen. For example:

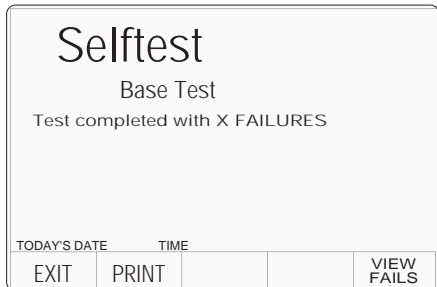

**EXIT** returns to the 'Select test' menu screen.

**PRINT** prints out the results of the test. Refer to *Sub-section 8.4*.

If failures were encountered, **EXIT** and **PRINT** remain available. Also, the number of failures is shown on the screen, and an extra selection will be available:

### VIEW FAILS

sets up a special screen for detailing the parameters of the failures encountered (described later in Paras 8.3.2.3).

#### 8.3.2.3 Viewing the Test Results

By pressing the **VIEW FAILS** screen key, each of the failed tests can be viewed in turn, on a screen which shows the test number (pathway), measured value, upper and lower limits, and the value of the error. A brief description of the test is also given in a box beneath the values.

The screen for viewing the test results is shown below. This can also appear when a test has been aborted.

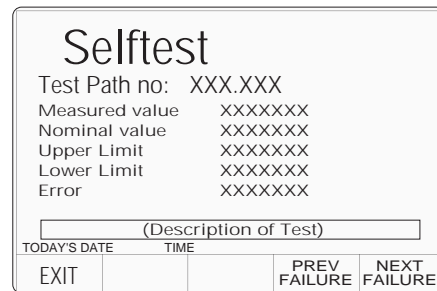

**N.B.** If the cause of failure is not immediately obvious, and it is intended to consult your Fluke Service Center, please ensure that you *either*: copy the details from the screen for all the reported failures, *or*: print out the results.

### NEXT FAILURE

Once the details of the first failure have been noted, the next failure in the list can be viewed by pressing the **NEXT FAILURE** screen key. The list of failures remains in memory until the next selftest is started, and the **PREV FAILURE** screen key can be used to help scan the list one at a time. Once the last failure in the list is on the screen, and the **NEXT FAILURE** screen key is pressed, the following error message will appear in the top right of the screen:



Pressing the **NEXT FAILURE** screen key will have no further effect.

#### 8.3.2.4 Printing the Test Results

The **PRINT** screen key is present on the 'ABORTED' or 'completed' screens after the test has run to completion or has been aborted. Pressing the **PRINT** key will print out all the available results.

Printing will only be possible if a suitable printer is set up, connected and on line. Refer to *Sub-section 8.4*.

*Final Width = 215mm*

*Continued Overleaf→*

### 8.3.3 Selftest at Power-On

**N.B.** Certain catastrophic 'System Trip Errors' may cause the display to flash on and off, at the point of setting power on. In this case, **immediately switch Power Off** and report the fault to your Service Center.

The first normal action at power on is to show the Fluke logo, and then the 9500B will run a fast selftest:



Final Width = 215mm

If no failures are found, the 9500B will revert to the default power-up mode, which is either Manual mode or Procedure mode.

If System Trip failures are encountered the 9500B will show the System Trip screen ('RESUME').

If non-trip failures are encountered the 9500B will lapse into Test mode at the following stage:

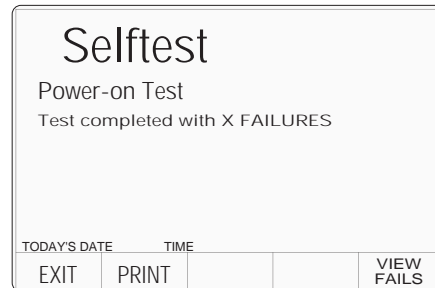

Subsequent action to view the failures and print the results follows as for a Fast selftest which has run to completion (*paras 8.3.2.2/3*).

**EXIT** will return to the 'Select test' menu screen, where, to return to the 'Mode Selection' menu screen, press the front panel **Mode** key.

**PRINT** can be used to print out the results of the power-on Fast test. Refer also to *Sub-section 8.4*.

### 8.3.4 Interface Test

The interface test selectively checks the 9500B front panel operations, covering display memory integrity, keyboard operation, the display itself, integrity and formatting of static RAM memory cards for Procedure mode, the correct operation of a connected tracker-ball, and the correct operation of a connected printer.

#### 8.3.4.1 Access to Interface Tests

Once the Test mode has been selected, Interface Test is selected by pressing the **INTERFACE** screen key in the 'Select test' menu:

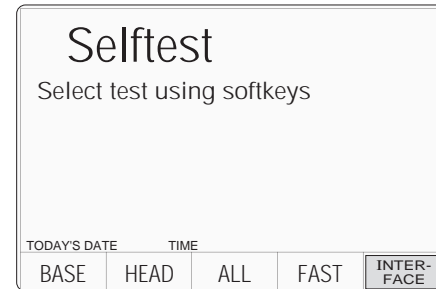

Pressing **INTERFACE** transfers to the 'Select test' menu screen:



The required check can be selected from the list on the right of the screen, using the corresponding screen key.

**EXIT** returns to the previous 'Select required test' menu screen.

The six available checks are detailed, in list order, in the following paragraphs.

#### 8.3.4.2 Display Memory Checks

Pressing the DISPLAY MEMORY key on the 'Select test' menu screen transfers to the 'Memory test.' screen, and the sequence of tests begins. The test in progress is reported on the screen:

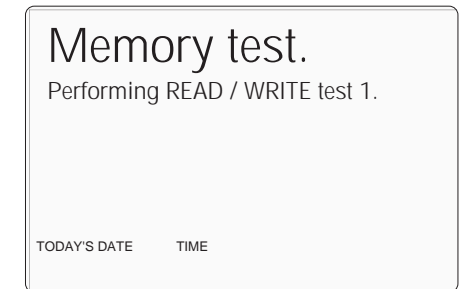

The other tests reported are:

- Performing WALKING ONES test 1.
- Performing READ/WRITE test 2.
- Performing WALKING ONES test 2.

The result of the whole Memory test is reported once testing is complete:

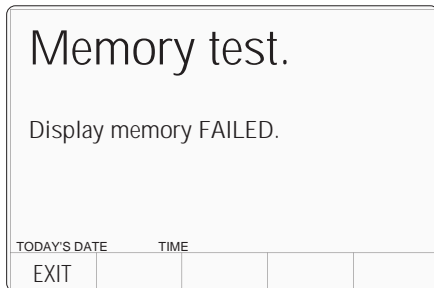
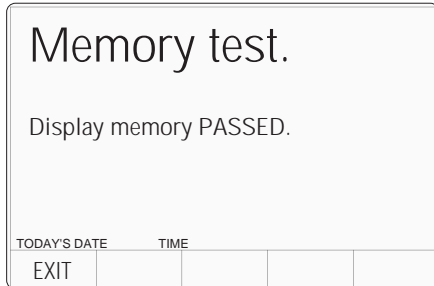

If a failure is reported, rectification will require access to the internal circuitry, so no further user action is recommended, except to report the result to your Fluke Service Center.

**EXIT** returns to the Interface 'Select test' menu screen.

### 8.3.4.3 Keyboard Checks

Keyboard checks are initiated by pressing the KEYBOARD key on the 'Select test' menu screen:



Selecting 'KEYBRD' transfers to the 'Keyboard test.' screen. This invites a user to press the front panel key to be tested, and reports on the screen the details of the last key to be pressed:

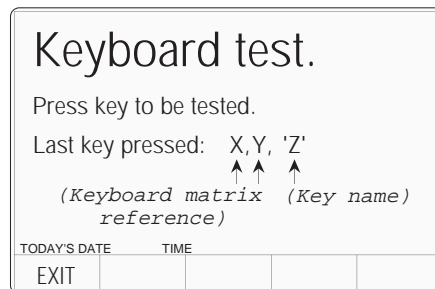

The 'Keyboard matrix reference' (X,Y) relates to the electronic matrix which is used to transfer keypress information to the internal processor, and does not relate closely to the physical layout of keys. The 'Key name' (Z) is the name, in words, which describes the last key to be pressed.

If the reported key name does not coincide with the function of the last key to be physically pressed, a failure is implied. Rectification will require access to the internal circuitry, so no further user action is recommended, except to report the result to your Fluke Service Center.

**EXIT** returns to the Interface 'Select test' menu screen.

### 8.3.4.4 Display Checks

Display checks are initiated by pressing the DISPLAY key on the 'Select test' menu screen:



Selecting 'DISPLAY' transfers to the 'Display test.' screen. This invites a user to use the front panel 'tab' (⊞) key to move the dark band down the screen, up to the top, and down again, thus testing all the display elements on the screen:

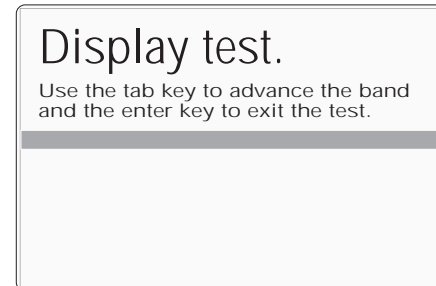

The screen text will shift automatically so as not to obscure the band as it jumps back to the top of the screen. If there are elements of the screen which do not show light in the light background or dark in the dark band as it is advanced down the screen, then this implies a failure. Rectification will require access to the internal circuitry, so no further user action is recommended, except to report the result to your Fluke Service Center.

The 'Enter' Key (↵) returns to the Interface 'Select test' menu screen.

*Final Width = 215mm*

### 8.3.4 Interface Test (Contd.)

#### 8.3.4.5 Memory Card Checks

Memory Card checks are initiated by pressing the MEMORY CARD key on the 'Select test' menu screen:

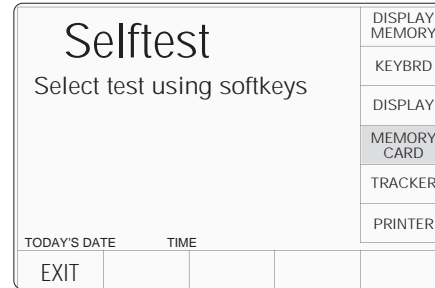

Pressing the MEMORY CARD key on the 'Select test' menu screen transfers to the 'Card slot test.' screen. This invites a user to select the memory card slot to be tested, and presents an 'Overwrite' warning:

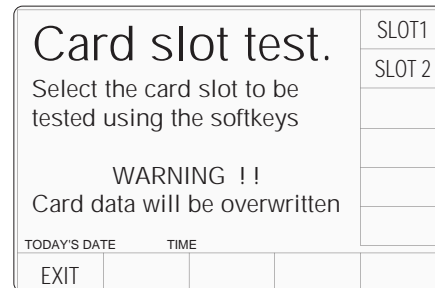

- SLOT 1** selects 'PCMCIA SLOT 1' for testing.
- SLOT 2** selects 'PCMCIA SLOT 2' for testing.
- EXIT** returns to the Interface 'Select test' menu screen.

Either slot can be used for the test. If one particular slot is suspect then that, naturally, will be the one to choose.

The **WARNING!!** gives notice that the inserted memory card will be overwritten by this test. This is because reformatting is required to perform the checks and the card inserted into the slot will be reformatted as a Results card. The 9500B first checks for the presence of the correct SRAM card. If there is no card in the slot, if the card in the slot is not a SRAM card, or if it is a SRAM card but not write-enabled, then the following screen is displayed:

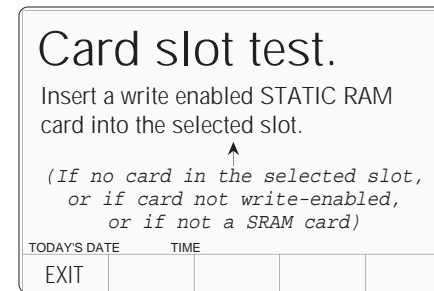

After correcting the defect, press the OK screen key. This transfers to a new screen, and the sequence of tests begins. The test in progress is reported on the screen.

The 9500B first checks the state of the card's internal battery. If the battery voltage is low, this will be stated on the screen:

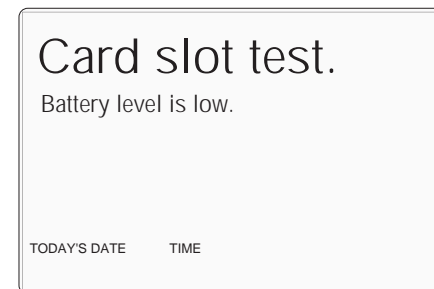

If there is no battery in the card, or if the battery cannot support read/write operations, then the statement will be 'Battery level is dead.'

**Note:**

For a re-chargeable card with a low battery, the low/dead message may take several minutes to clear after pressing **OK**.

The next test is to check the size of the card memory. While the 9500B is checking, it will place the following message on the screen:

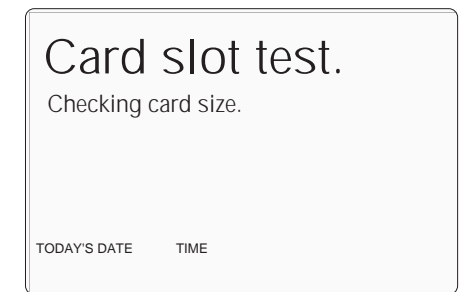

Once the size check is completed, the 9500B starts on a 'read/write' check; meanwhile the display changes to:

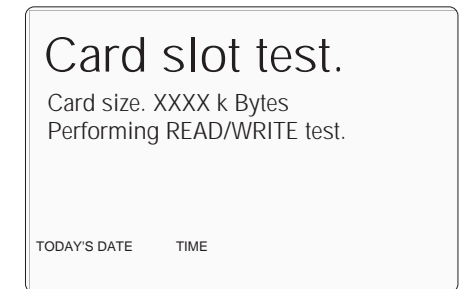

After the read/write check, the 9500B starts on a 'walking ones' check, and the message on the display changes to:

Performing WALKING ONES test.

Final Width = 215mm



The test continues, this time to format the memory into 'Results Card' format. A new message appears on the display:

Performing RESULTS CARD format.

Providing that the full range of tests and formatting is completed successfully, the PASS statement is added to the screen:

<b>Card slot test.</b>				
Card size. XXXX k Bytes				
Performing RESULTS CARD format.				
Selected card interface PASSED.				
TODAY'S DATE		TIME		
EXIT				

**EXIT** returns to the Interface 'Select test' menu screen.

If the test fails at any point, then the test will stop, leaving the heading for the failed test on the screen, followed by a failure statement. For example, if the failure occurred during the 'walking ones' check, then the following screen would be presented:

<b>Card slot test.</b>				
Card size. XXXX k Bytes				
Performing WALKING ONES test.				
Selected card interface FAILED.				
TODAY'S DATE		TIME		
EXIT				

To diagnose the reason for a failure, there are several further checks which can be made to localize the fault. Firstly, an attempt should be made to re-check the same card in the other slot, then if this is successful, check a new card in the original slot. This should narrow the

fault down to one slot or one card. If it is suspected that the 9500B is at fault, it is wise to report the result to your Fluke Service Center.

**EXIT** returns to the Interface 'Select test' menu screen.

### 8.3.4.6 Tracker Ball Checks

Checks of a connected tracker ball are initiated by pressing the TRACKER key on the 'Select test' menu screen:

Selecting 'TRACKER' transfers to the 'Tracker

<b>Selftest</b>					DISPLAY MEMORY
Select test using softkeys					KEYBRD
					DISPLAY
					MEMORY CARD
					TRACKER
					PRINTER
TODAY'S DATE		TIME			
EXIT					

test.' screen. This invites a user to use a tracker ball to test the interface, and reports on the screen the details of the last key to be pressed, and the last movement of the ball:

The possible responses are shown on the

<b>Tracker test.</b>				
Use a tracker ball to test interface.				
Last key pressed: LEFT/RIGHT.				
Last direction: UP/DOWN/LEFT/RIGHT.				
TODAY'S DATE		TIME		
EXIT				

diagram. Note that the center key on the tracker has no function in its operation with the 9500B, and is not tested, so pressing this key should have no effect, unless the tracker is defective.

If the last key to be named does not coincide

with the last key to be physically pressed, or if the last direction shown does not correspond to the last physical movement; then a failure is implied. It is possible to diagnose the defect source by checking a second tracker unit on the same 9500B, or the same tracker unit on a different 9500B. Rectification may require access to the internal circuitry of the 9500B or tracker unit, so no further user action is recommended, except to report the result to your Fluke Service Center.

**EXIT** returns to the Interface 'Select test' menu screen.

### 8.3.4.7 Printer Checks

Checks of a connected printer are initiated by pressing the PRINTER key on the 'Select test' menu screen:

Selecting 'PRINTER' transfers to the 'Printer

<b>Selftest</b>					DISPLAY MEMORY
Select test using softkeys					KEYBRD
					DISPLAY
					MEMORY CARD
					TRACKER
					PRINTER
TODAY'S DATE		TIME			
EXIT					

test.' screen. This invites a user to use a printer to test the interface (e.g. by switching the printer off-line, or removing the paper), and reports on the status of the printer:

**Note:** If the printer is disabled (Config mode

*Continued overleaf*→

*Final Width = 215mm*

## 8.4 Printing Selftest Results

### 8.3.4 Interface Test (Contd.)

### Printer test.

Use a printer to test interface  
Press EXIT to stop printout.  
Printer status: NOT RESPONDING/  
OUT OF PAPER.

TODAY'S DATE	TIME		
EXIT			

— Section 3), the printer will not be set up when starting to print for the first time.

The possible responses are shown on the diagram. They are updated automatically as the printer status changes. When operating correctly, the printer will print a character-set continuously until the EXIT screen key is pressed.

If the reported status of the printer interface does not match the known physical status, then this implies a failure. It is possible to diagnose the defect source by checking a second printer unit on the same 9500B, or the same printer unit on a different 9500B. Rectification may require access to the internal circuitry of the 9500B or printer unit, so no further user action is recommended, except for obvious setup errors. Otherwise it is advisable to report the result to your Fluke Service Center.

**EXIT** returns to the Interface 'Select test' menu screen.

*Final Width = 215mm*

### 8.4.1 Introduction

The results of All and Fast selftests can be printed out by a printer connected to the parallel port J103 on the rear panel. It can also be used to print out certificates for UUTs calibrated in Procedure mode.

### 8.4.2 Parallel Port (Rear Panel)

This 25 way D-Type socket is located beneath the IEEE-488 connector on the rear panel. Its connections are similar to the 25-way printer port on PCs, carrying control and data for an external printer as designated in the table.

#### Pin Layout

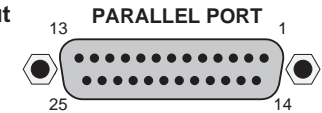

#### Pin Designations

9500B Pin No.	9500B Signal Name	9500B I/O	Description or Common Meaning
1	STROBE_L	Output	1µs pulse to cause printer to read one byte of data from data bus DO1 — DO8.
2	DO1	Output	Data bit 1
3	DO2	Output	Data bit 2
4	DO3	Output	Data bit 3
5	DO4	Output	Data bit 4
6	DO5	Output	Data bit 5
7	DO6	Output	Data bit 6
8	DO7	Output	Data bit 7
9	DO8	Output	Data bit 8
10	ACKNLG_L	Input	Pulse to indicate that the printer has accepted a data byte, and is ready for more data.
11	BUSY_H	Input	Printer is temporarily busy and cannot receive data.
12	P_END_H	Input	Printer is out of paper.
13	SLCT_H	Input	Printer is in online state, or connected.
14	AUTO_FEED_L	Output	Paper is automatically fed 1 line after printing. This line is fixed _H (high) by the 9500B to disable autoseed.
15	ERROR_L	Input	Printer is in 'Paper End', 'Offline' or 'Error' state.
16	INIT_L	Output	Commands printer to reset to power-up state, and in most printers to clear its print buffer.
17	SLCT_IN_L	Output	Commands some printers to accept data. This line is fixed _L (low) by the 9500B.
18-25	OV_F	Output	Digital Common

\_H ≡ Logic-1 active; \_L ≡ Logic-0 active.

---

### 8.4.3 Printing Setup

The results of Base, Heads, All and Fast selftest operations can be printed directly via the rear panel parallel port J103. A suitable printer must be connected and switched on-line; then the 9500B internal program will generate the required results.

#### 8.4.3.1 Printer Type

The printer to be used should be capable of printing 120 characters per line, and must be able to print the Code Page 437 character set. Most printers compatible with Epson FX, Canon Bubble-Jet or Hewlett-Packard Desk-Jet are suitable.

#### 8.4.3.2 Data Formatting

The required printout style, format and data is pre-determined depending on whether Base, Heads, All and Fast test results are being printed, and on the type of printer to be used. It is necessary to *enable* a particular printer type via Configuration mode, only if the format for that printer is required.

**Note:** If the printer is disabled (Config mode — *Volume 1, Section 3, paras 3.3.2.6*), the printer will not be set up when starting to print for the first time.

### 8.4.4 Results Printout

Apart from the heading: Base, Heads, All and Fast test results have the same printed layout. The results of tests on all test pathways are collected together in a table. A typical sample of a table is given below:

*Final Width = 215mm*

Serial No: XXXXX S/W Issue: X.XX Date: XX/YY/ZZZZ Time: 12:41 Type: ALL

TEST PT	MEAS VALUE	NOMINAL	MIN LIMIT	MAX LIMIT	ERR %	FAILURES
D08.001	+5.289216	+5.000000	+4.500000	+5.000000	+60	
D08.002	-5.486493	-5.200000	-5.600000	-4.000000	-72	
D08.003	+14.646128	+15.000000	+14.250000	+15.750000	-47	

**ERR %** gives the achieved percentage of full tolerance for that test.

**FAILURES** In this column a failure is shown by the figure '1' against the relevant test.

BLANK PAGE (LEFT-HAND)

## Error Reporting Subsystem

*Note to users:* For the sake of completeness, this appendix collects together the error codes which might be generated either on the instrument front panel, or via the IEEE 488 system bus.

### 8.A.1 Error Detection

All errors which cannot be recovered without the user's knowledge, result in some system action to inform the user via a message, and where possible restore the system to an operational condition. Errors are classified by the method with which they are handled. Recoverable errors report the error and then continue. System errors which cannot be recovered cause the system to reset via the Power-on state to a system trip error report state, from which a 'resume' may clear the error, but generally such messages are caused by hardware or software faults, which require user action.

### 8.A.2 Error Messages

#### 8.A.2.1 System Trip Errors

For all system trip errors, the error condition is reported only via the front panel. The error will pull the processor reset line to restart the system as at power-on. The screen will display a message indicating that there has been a system trip error and thus the processor has been reset. A user may continue by use of the 'resume' key, or from power on, and initiate repair if the fault persists.

The following is a list of error numbers, which will be displayed with their fault descriptions:

9501 - DAC Default Characterisation. Failed  
9502 - Failed to clear Flash RAM  
9504 - No ADC ready bit after 160ms  
9505 - Flash RAM protected by switch  
9510 - Measurement failed to complete  
9512, Output off request did not complete  
9514, Output Off Expected  
9515, Main unit control loop failure  
9516, Internal overheating: Check air vents  
9517, Internal frequency Failed to re-lock  
9518, ADC failed to complete measurement  
9519, Rf DAC control loop failure  
9520, TV waveform control loop failure

For the following errors, an error number will be allocated at run time:

UNDEFINED SYSTEM TRIP ERROR  
OPERATING SYSTEM ERROR

#### 8.A.2.2 Recoverable Errors

##### 8.A.2.2.1 Type of Errors

These consist of **Command Errors**, **Execution Errors**, **Query Errors** and **Device-Dependent Errors**. Command, Query and Execution Errors are generated due to incorrect remote programming. Device-Dependent Errors can be generated by manual as well as remote operation. Each of the reportable errors is identified by a code number.

##### 8.A.2.2.2 Error Reporting

In response to a bus or a keyboard error, there are certain categories of error reporting. Primarily, the error will be reported to the original source of the error, but in some cases will be reported to both local and remote operators. Locally, the error will be displayed on the front-panel screen; remotely, it will set the relevant ESR bit, and add the error to the Error Queue.

##### Note about the ERROR Queue

(accessible via the IEEE-488 Interface)

The Error Queue is a sequential memory stack. Each reportable error has been given a listed number and explanatory message, which are entered into the error queue as the error occurs. The queue is read destructively as a First-In/First-Out stack, using the query command `SYSTEM :ERRor?` to obtain a code number and message.

Repeated use of the query `SYSTEM :ERRor?` will read successive Device-Dependent, Command and Execution errors until the queue is empty, when the 'Empty' message (0,"No error") will be returned.

It would be good practice to repeatedly read the Error Queue until the 'Empty' message is returned.

The common command `*CLS` clears the queue.

*Final Width = 215mm*

**ALWAYS: record the total message content for possible use by the Service Center.**

Final Width = 215mm

## 8.A.2.2 Recoverable Errors (Contd.)

### 8.A.2.2.3 Command Errors (CME)

(Remote operation only)

#### Command Error Generation

A Command Error is generated when the remote command does not conform, either to the device command syntax, or to the IEEE 488.2 generic syntax. The CME bit (5) is set *true* in the Standard-defined Event Status Byte, and the error code number is appended to the Error Queue.

#### Command Error Reporting

The error is reported by the mechanisms described earlier in *Section 6, Sub-section 6.5*, which deals with status reporting.

The Command Errors implemented in the 9500B are listed below; their error numbers conform to those defined in the SCPI Standard document:

```
-100, "Command error"
-101, "Invalid character"
-103, "Invalid separator"
-104, "Data type error"
-105, "GET not allowed"
-108, "Parameter not allowed"
-110, "Command header error"
-113, "Undefined header"
-120, "Numeric data error"
-121, "Invalid character in number"
-123, "Exponent too large"
-124, "Too many digits"
-150, "String data error"
-160, "Block data error"
-161, "Invalid block data"
-178, "Expression data not allowed"
```

### 8.A.2.2.4 Execution Errors (EXE)

(Remote operation only)

#### Execution Error Generation

An Execution Error is generated if a received command cannot be executed due to it being incompatible with the current device state, or because it attempts to command parameters which are out-of-limits.

In remote operation, the EXE bit (4) is set *true* in the Standard-defined Event Status Byte, and the error code number is appended to the Error queue.

#### Execution Error Reporting

The error is reported by the mechanisms described earlier in *Section 6, Sub-section 6.5*, which deals with status reporting.

The Execution Error numbers are given below, with their associated descriptions.

```
-220, "Parameter error"
-221, "Settings conflict"
-222, "Data out of range"
-223, "Too much data"
-224, "Illegal parameter value"
-241, "Hardware missing"
-258, "Media protected"
```

### 8.A.2.2.5 Query Errors (QYE)

(Remote operation only)

#### Query Error Generation

A Query Error is generated when the controller fails to follow the Message Exchange Control Protocol as follows:

- **DEADLOCK State**

The device has been asked to buffer more data than it has room to store; the Output Queue is full, blocking the Response Formatter, Execution Control and Parser; the Input Buffer is full, and the controller is waiting to send more data bytes to the device.

- **UNTERMINATED Action**

The controller attempts to read a Response Message from the device without first having sent a complete Query Message, including the Program Message Terminator.

- **INTERRUPTED Action**

The device is interrupted by a new Program Message before it finishes sending a Response Message.

#### Query Error Reporting

The QYE bit (2) is set *true* in the Standard-defined Event Status Byte, and the error code number is appended to the Error queue. The error is reported by the mechanisms described earlier in *Section 6, Sub-section 6.5*, which deals with status reporting.

The specific reason for a query error must be determined by inspection of the command program. No error codes are provided from within the 9500B.

### 8.A.2.2.6 Device-Dependent Errors (DDE)

A Device-Dependent Error is generated if the device detects an internal operating fault (eg. during self-test). The DDE bit (3) is set *true* in the Standard-defined Event Status Byte, and the error code number is appended to the Error queue. The error description appears on the display, remaining visible until the next key-press or remote command.

Errors are reported by the mechanisms described earlier in *Section 6, Sub-section 6.5*, which deals with status reporting.

**ALWAYS: record the total message content for possible use by the Service Center.**

---

### 8.A.2.2.7 Device-Dependent Errors Reported only Locally on the Front Panel Screen

The error list for local operations, which are not reported to the remote operator, is given below:

Note that the error *number* will not be presented on the screen

-7001, "Entry contains illegal characters"	-9001, "No calibration necessary for this function"
-7002, "Entered value is outside the allowed range"	-9002, "Target factor is corrupt - select defaults"
-7003, "Day entry is not a valid number"	-9008, "Edge speed outside limits"
-7004, "Day separator is incorrect"	-9009, "Restricted period for this amplitude"
-7005, "Month entry is not a valid number"	-9010, "Maximum limit"
-7006, "Month separator is incorrect"	-9011, "Minimum limit"
-7007, "Century entry is not a valid number";	-9012, "Outside amplitude range"
-7008, "Year entry is not a valid number"	-9013, "Maximum amplitude for 50Ω load";
-7009, "Year separator is incorrect"	-9014, "Outside frequency range"
-7010, "Month entry is not a valid month"	-9015, "Outside amplitude range for DC";
-7011, "Day entry is not a valid day"	-9016, "Outside Period range"
-7012, "Hours entry is not a valid number"	-9017, "Outside deviation range"
-7013, "Minutes entry is not a valid number"	-9018, "Deviation restricted by frequency range"
-7014, "Entry does not give a valid time setting"	-9019, "Deviation restricted by amplitude range";
-7016, "Bus address must be within the range 0 - 30"	-9020, "Syntax error"
-7017, "Safety voltage must be within the range 10V and 110V"	-9021, "Outside numeric range"
-7018, "Borderline value must be within the range 10.00 - 99.99%"	-9022, "Only a restricted setting available"
-7019, "Entry does not match previous password entry"	-9023, "Maximum frequency for this waveform is 1.11MHz"
-7020, "New string contains illegal characters or values."	-9024, "Minimum highlight period is 20ns"
-7024, "WARNING Instrument near cal due date"	-9025, "No further display ranges available"
-7025, "WARNING Instrument past cal due date"	-9026, "No further options"
-7026, "Ref frequency must be within the range 0.1 Hz and 1.3 GHz"	-9027, "Current probe accessory must be fitted to active head"
-7027, "Ref frequency must be within the range 0.1 Hz and 3.2 GHz"	-9028, "Outside energy range"
-7029, "Ext Ref must be locked for selection to be allowed"	-9029, "Entered number exceeds limits"
	-9030, "Channel already in use"
	-9031, "Outside skew range"
	-9032, "VCO characterisation failed"
	-9041, "Invalid number of divisions"
	-9042, "Invalid units per division"
	-9043, "Units per div, number of div's combination outside range"
	-9044, "Maximum units per division for 50Ω load"
	-9050, "Printer is not responding"
	-9051, "Printer out of paper"
	-9053, "Previous test point failed - exceeded UUT spec. limits"
	-9060, "Invalid test number"
	-9062, "No more failures to view"
	-9063, "No more tests to execute"
	-9067, "Search procedure - NO test point"
	-9068, "Search procedure - Function ID expected"
	-9069, "Test ... must be executed first"
	-9070, "Please wait - safety delay"
	-9071, "Dual channel sine amplitude restricted to 2.78V"
	-9072, "Dual channel sine amplitude restricted to 1.668V"
	-9073, "Maximum frequency for 1M\352 load";3
	-9074, "Selected head restricts frequency to 1.1GHz";
	-9075, "Multi-channel DC requires 1M\352 impedance"
	-9076, "Outside Pulse Width range"
	-9077, "9560 Dual channel sine frequency restricted to 3.2GHz"

*Final Width = 215mm*

**ALWAYS: record the total message content for possible use by the Service Center.**

### 8.A.2.2.8 Device-Dependent Errors Reported only Remotely via the IEEE-488 Interface

The error list for remote operations, which are not reported on the front panel screen, is given below:

-300,"Device specific error"	-330,"Configuration memory lost"
-312,"PUD memory lost"	-350,"Queue overflow"
-315,"Selftest failed"	

### 8.A.2.2.9 Device-Dependent Errors Reported both Locally and Remotely

Errors are reported both on the front panel screen and via the IEEE-488 interface. Note that the locally-presented error message will not include the error *number*.

#### General

1001, "Active head removed with output on"	1049, "CH5 Load mismatch detected: UUT <50k\352"
1002, "Softkey label too long"	1050, "CH1 Load mismatch detected: UUT >150\352"
1003, "Confirm with ON"	1051, "CH2 Load mismatch detected: UUT >150\352"
1004, "Unknown keycode"	1052, "CH3 Load mismatch detected: UUT >150\352"
1006, "CH1 head control update failure"	1053, "CH4 Load mismatch detected: UUT >150\352"
1007, "CH2 head control update failure"	1054, "CH5 Load mismatch detected: UUT >150\352"
1008, "CH3 head control update failure"	1055, "9560 head required for sine greater than 3.2GHz"
1009, "CH4 head control update failure"	1056, "This function is not available from a 9560 head"
1010, "CH5 head control update failure"	1057, "9560 head does not provide 1M\352 in this function"
1011, "Loss of external reference frequency lock"	1058, "9560 cannot source 1M\352 trigger signals"
1012, "Load <50Ω detected, output off to avoid damage"	1059, "9560 requires a 3.2GHz option base"
1013, "Internal frequency lock has been performed"	1060, "Incompatible heads for dual sine mode"
1014, "Load mismatch detected: UUT <50kΩ"	1061, "9560 head required for timing marker < 450ns"
1015, "Load mismatch detected: UUT >150Ω"	1062, "9560 head required for 70ps edge"
1016, "Loss of internal reference frequency lock"	1063, "Calibration of this function not allowed with a 9560"
1017, "Trigger cable deselected with output on"	1064, "Multi-channel DC cannot mix 9560 with other head types"
1018, "No head present on channel 1"	1065, "Pulse Width characterisation requires 9500B hardware"
1019, "No head present on channel 2"	
1020, "No head present on channel 3"	5010, "Priority OFF received"
1021, "No head present on channel 4"	5011, "Gain request limited"
1022, "No head present on channel 5"	5012, "Failed to read from flash RAM"
1023, "Active signal cable removed with output on"	5013, "Corrupt VCO correction"
1024, "Head interrupt - OFF timeout"	5014, "Failed to save VCO correction"
1025, "Zero Skew requires at least two heads"	5015, "Corrupt lf sin dc offset correction"
1026, "Output must be ON"	5016, "Failed to save lf sin dc offset correction"
1027, "Alignment must be adjusted before deselecting default"	5017, "Corrupt timing marker zero correction"
1028, "Head on channel 1 has not been recognised"	5018, "Failed to save timing marker zero correction"
1029, "Head on channel 2 has not been recognised"	5019, "Corrupt timing marker peak correction"
1030, "Head on channel 3 has not been recognised"	5020, "Failed to save timing marker peak correction"
1031, "Head on channel 4 has not been recognised"	5021, "Timing marker peak failed, setting defaults"
1032, "Head on channel 5 has not been recognised"	5022, "Octal dac value out of range, using default"
1033, "9520 head or better required for 150ps edge"	5023, "Peak detect not cleared, setting defaults"
1034, "9530 head required for sine greater than 1.1GHz"	5025, "VCO unchrs'd - Using default"
1035, "Command not available for single channel configuration"	5027, "Frequency Crystal DAC unchrs'd - Using default"
1036, "Base unit cannot calibrate at required frequency"	5028, "LF sine DC offset unchrs'd - Using default"
1037, "9550 head required for 25ps edge"	5029, "Triangular TMks unchrs'd - Using default"
1038, "9550 head can only be used for 25ps edge"	5030, "Crystal DAC chrsn corrupt - Using default"
1039, "At least one signal channel must always be selected"	5031, "Square TMk chrsn failed - setting defaults"
1040, "CH1 Load <50k\352 detected, output off to avoid damage"	5032, "Failed to save Square TMk chrsn failed"
1041, "CH2 Load <50k\352 detected, output off to avoid damage"	5033, "Square TMk chrsn unchrs'd - Using default"
1042, "CH3 Load <50k\352 detected, output off to avoid damage"	5034, "Square TMk chrsn corrupt - Using default"
1043, "CH4 Load <50k\352 detected, output off to avoid damage"	5035, "Pulse Width Failed to characterise"
1044, "CH5 Load <50k\352 detected, output off to avoid damage"	5036, "Pulse width uncharacterised - Using default"
1045, "CH1 Load mismatch detected: UUT <50k\352"	
1046, "CH2 Load mismatch detected: UUT <50k\352"	
1047, "CH3 Load mismatch detected: UUT <50k\352"	
1048, "CH4 Load mismatch detected: UUT <50k\352"	

**ALWAYS: record the total message content for possible use by the Service Center.**

*Final Width = 215mm*



---

## Calibration

4001, "Corrupt calibration store, using default"  
4002, "NVRAM Failed to save configuration"  
4003, "Password incorrect"  
4004, "Calibration switch not enabled"  
4005, "Password incorrect"  
4007, "Amplitude outside limits"  
4008, "Calibration is password protected"  
4009, "Frequency outside limits"  
4010, "Invalid calibration function"  
4011, "Output must be ON for CAL"  
4021, "No more targets available"  
4022, "Failed to save (sv\_tgt) factor"  
4023, "Failed to save (sv\_frq) factor"  
4024, "Failed to save (act) factor"  
4025, "Failed to save (tgt) factor"  
4026, "Failed to save (frq) factor"  
4027, "NVRAM Failed to save (R-eqV) factor"  
4028, "Limits: R-eqV"  
4029, "NVRAM Failed to save (act) R-dervd"  
4030, "NVRAM Failed to save (tgt) R-dervd"  
4031, "NVRAM Failed to save (act) C-ref"  
4032, "NVRAM Failed to save (tgt) C-ref"  
4033, "NVRAM Failed to save (frq) C-ref"  
4034, "NVRAM Failed to save (C-eqV) factor"  
4035, "NVRAM Failed to save (cjc) factor"  
4051, "Cap meas no 1st reading"  
4052, "Cap meas no 2nd reading"  
4053, "Cap meas outside limits"  
4055, "Corrupt calibration factors"  
4056, "Failed -----"  
4057, "Corrupt selfcal factor"  
4058, "Corrupt res. ref. factor"  
4059, "Corrupt offset DAC factor"  
4060, "DAC un-characterised, using defaults"  
4201, "Head calibration store corrupt, using default"  
4202, "Incompatible head inserted"  
4203, "Head data area corrupt"  
4204, "Insufficient memory to save head cal factors"  
4205, "Could not locate head cal factors, using defaults"  
4206, "9560 requires a 16k EEPROM fitted in the head"  
4207, "Head read failed"  
4208, "Head write failed"  
4209, "WARNING: Head on channel 1 is past cal due date"  
4210, "WARNING: Head on channel 2 is past cal due date"  
4211, "WARNING: Head on channel 3 is past cal due date"  
4212, "WARNING: Head on channel 4 is past cal due date"

4213, "WARNING: Head on channel 5 is past cal due date"  
4214, "WARNING: Head on channel 1 is near cal due date"  
4215, "WARNING: Head on channel 2 is near cal due date"  
4216, "WARNING: Head on channel 3 is near cal due date"  
4217, "WARNING: Head on channel 4 is near cal due date"  
4218, "WARNING: Head on channel 5 is near cal due date"  
4219, "WARNING: Unable to restore previous cal data"  
4220, "WARNING: Previous cal outside limits - using defaults"  
4221, "WARNING: Cal data not stored: Exit again to abandon data"

## Characterization

4501, "Limits: main DAC gain"  
4502, "Limits: composite DAC zero"  
4503, "Limits: trim DAC gain"  
4504, "Limits: offset DAC gain"  
4505, "Limits: main DAC linearity"  
4506, "Failed to write to flash RAM"  
4507, "Limits: gain of 2 zero"  
4508, "Limits: gain of 0.5 zero"  
4509, "Limits: DAC output zero"  
4510, "Limits: 0.75 buffer zero"  
4511, "Limits: DAC positive zero"  
4512, "Limits: DAC negative zero"  
4513, "Limits: DAC positive FR"  
4514, "Limits: DAC negative FR"  
4515, "Limits: DAC ±FR ratio"  
4516, "Limits: DAC max - DAC min"  
4517, "Limits: resistor ratios"  
4518, "Failed to save resistor ratios"  
4519, "Limits: main DAC offset"  
4520, "Failed to save impedance offset"  
4521, "LF AC Chroctn impossible: default set"  
4522, "Excess LF AC flatness"  
4523, "Failed to save DDS lfac error"  
4524, "Limits: Gain of 1 zero"

*Final Width = 215mm*

**ALWAYS: record the total message content for possible use by the Service Center.**

*Final Width = 215mm*

---

### **DAC Compensation**

5001, "Corrupt main DAC gain"  
5002, "Corrupt trim DAC gain"  
5003, "Corrupt composite DAC zero"  
5004, "Corrupt lookup table"  
5005, "Corrupt Vmax. Vmin"  
5006, "Corrupt +ve zero (DAC)"  
5007, "Corrupt -ve zero (DAC)"  
5008, "Corrupt polarity gain (DAC)"  
5009, "Corrupt LFAC correction"  
5011, "Gain request limited"

### **Configuration**

4002, "Failed to save configuration"  
-7003, "Day entry is not a valid number"  
-7004, "Day separator is incorrect"  
-7005, "Month entry is not a valid number"  
-7006, "Month separator is incorrect"  
-7007, "Century entry is not a valid number"  
-7008, "Year entry is not a valid number"  
-7009, "Year separator is incorrect"  
-7010, "Month entry is not a valid month"  
-7011, "Day entry is not a valid day"  
-7012, "Hours entry is not a valid number"  
-7013, "Minutes entry is not a valid number"  
-7014, "Entry does not give a valid time setting"  
-7015, "Cannot have duplicate bus addresses"  
-7016, "Bus address must be within the range 0 - 30"  
-7017, "Safety voltage must be within the range 10V and 110V"  
-7018, "Borderline value must be within the range 10.00 - 99.99 %"  
-7019, "Entry does not match previous password entry"  
-7020, "New string contains illegal characters or values."  
-7024, "WARNING Instrument near cal due date"  
-7025, "WARNING Instrument past cal due date"  
-7026, "Ref frequency must be within the range 0.1 Hz and 1.1 GHz"  
-7027, "Ref frequency must be within the range 0.1 Hz and 3.2 GHz"  
-7028, "Ref frequency must be within the range 0.1 Hz and 2.2 GHz"  
-7029, "Ext Ref must be locked for selection to be allowed"  
-7030, "Ref frequency must be within the range 0.1 Hz and 400 MHz"  
-7031, "Ref frequency must be within the range 0.1 Hz and 600 MHz"  
9990, "Program ASSERTION Trip:"

**ALWAYS: record the total message content for possible use by the Service Center.**

---

## Section 9 Verifying the Model 9500B Specification

### 9.1 About Section 9

Section 9 introduces the verification of Model 9500B performance, including the issue of traceability and a verification procedure.

### 9.2 Need for Verification

#### 9.2.1 Factory Calibration and Traceability

Factory calibration of the Model 9500B ensures full traceability up to and including National Standards. Its traceable accuracy figures are quoted in the specifications given in *Section 7*, and all relate to a 1-year calibration interval. These figures include all calibration uncertainties, including those of National Standards, and therefore constitute absolute accuracies.

#### 9.2.2 Verification on Receipt from the Factory

Each 9500B is despatched from the factory with a Certificate of Calibration, which gives detailed results of its pre-shipment performance. However, organizations may wish to confirm that all instruments perform within published specifications, on receipt from their manufacturers.

Such verification is only possible, however, if the user's organization possesses suitable standards equipment, of the necessary traceable accuracy. Without these standards, users may rely on an external support organization for verification, probably also using these organizations to recalibrate the unit at appropriate intervals.

#### 9.2.3 Verification after User-Calibration

Calibration against standards, as detailed in *Section 10* of this handbook, covers only the possible adjustments used to place corrections in the Mainframe calibration memory. Pre-calibration and post-calibration performance at each adjustment point can be assessed as part of the adjustment procedure. However, to cover all the required points, the procedure in this section should be used to verify pre- and post-calibration performance.

### 9.3 Equipment Requirements

As stated earlier, the standards required to verify that 9500B is within its published specifications must possess the necessary traceable accuracy.

Also note that the standards must operate within the optimum output conditions of the 9500B, as defined in the accuracy tables given in *Section 7* of this handbook — i.e. the measurement equipment should be able to operate within the relevant 9500B limits so that no additional accuracy figures have to be taken into account.

The specific equipment requirements for verifying individual functions are listed in the sub-sections detailing their verification procedures.

### 9.4 Interconnections

The form of interconnection required to ensure optimum conditions for verification measurements will depend on the individual function being verified, and on the measuring equipment connected to the 9500B's terminals. Suitable connections are described in the sub-sections detailing the functions' verification procedures.

### 9.5 Verification Points

The accuracy specifications detailed in *Section 7* of this handbook cover the full range of output values which can be generated by 9500B, and its accuracy can therefore be verified against the specification at any number of points in these output ranges.

*Final Width = 215mm*

---

This section recommends a set of verification points.

## 9.6 Specification Limits

For each chosen verification point it will be necessary to know absolute measurement limits which can be used to judge whether or not the 9500B is performing within its specification. As mentioned earlier, the accuracy specifications detailed in *Section 7* of this handbook are absolute accuracies which incorporate all the uncertainties involved in calibrating the 9500B up to and including those of National Standards.

## 9.7 Verification Procedure

### Suitability

The procedures given in this section to verify the Model 9500B specification are suitable for verification both after receipt from the factory, or when associated with user-calibration.

### Traceability

Where, to conform to quality standards, the 9500B is required to be traceable to higher standards; then all equipment used to verify the 9500B specification must also be traceable to those standards.

*Final Width = 215mm*

## 9.8 9500B Mainframe Verification by Functions

Sub-section 9.8 is a guide to the process of verifying the Model 9500B functions from the front panel. The following topics are covered:

- 9.8.1 DC/Square Function: DC Output
- 9.8.2 DC/Square Function: Square Output
- 9.8.3 LF Sine Function
- 9.8.4 Time Markers Function
- 9.8.5 Load Resistance Measurement Function
- 9.8.6 Pulse Width Function

The list of topics above are placed in the order in which the 9500B Mainframe functions should be verified. Although it is not essential to verify all the functions at any one time, functions higher in the list should be verified before those lower in the list.

### 9.8.1 Verifying the DC/Square Function: DC Voltage

#### 9.8.1.1 Summary

Equipment requirements are given at *para 9.8.1.2* and test interconnections at *para 9.8.1.3*.

The DC Function is verified by carrying out measurements of amplitude in the sequence given at *para 9.8.1.4*, at the verification points shown in *Tables 9.8.1.1* and *9.8.1.2*.

#### 9.8.1.2 Equipment Requirements

- The UUT Model 9500B Mainframe, with 9510 or 9530 Active Head.
- A high resolution Standards DMM with DC Voltage accuracy of  $\pm 0.005\%$  or better, from 1mV to 200V.  
*Example: Model 1281 Digital Multimeter.*
- An adaptor to convert from BNC to 4mm leads.  
*Example: Model 4955 Calibration Adaptor.*
- Short, high-quality 4mm leads.

### 9.8.1.3 Interconnections

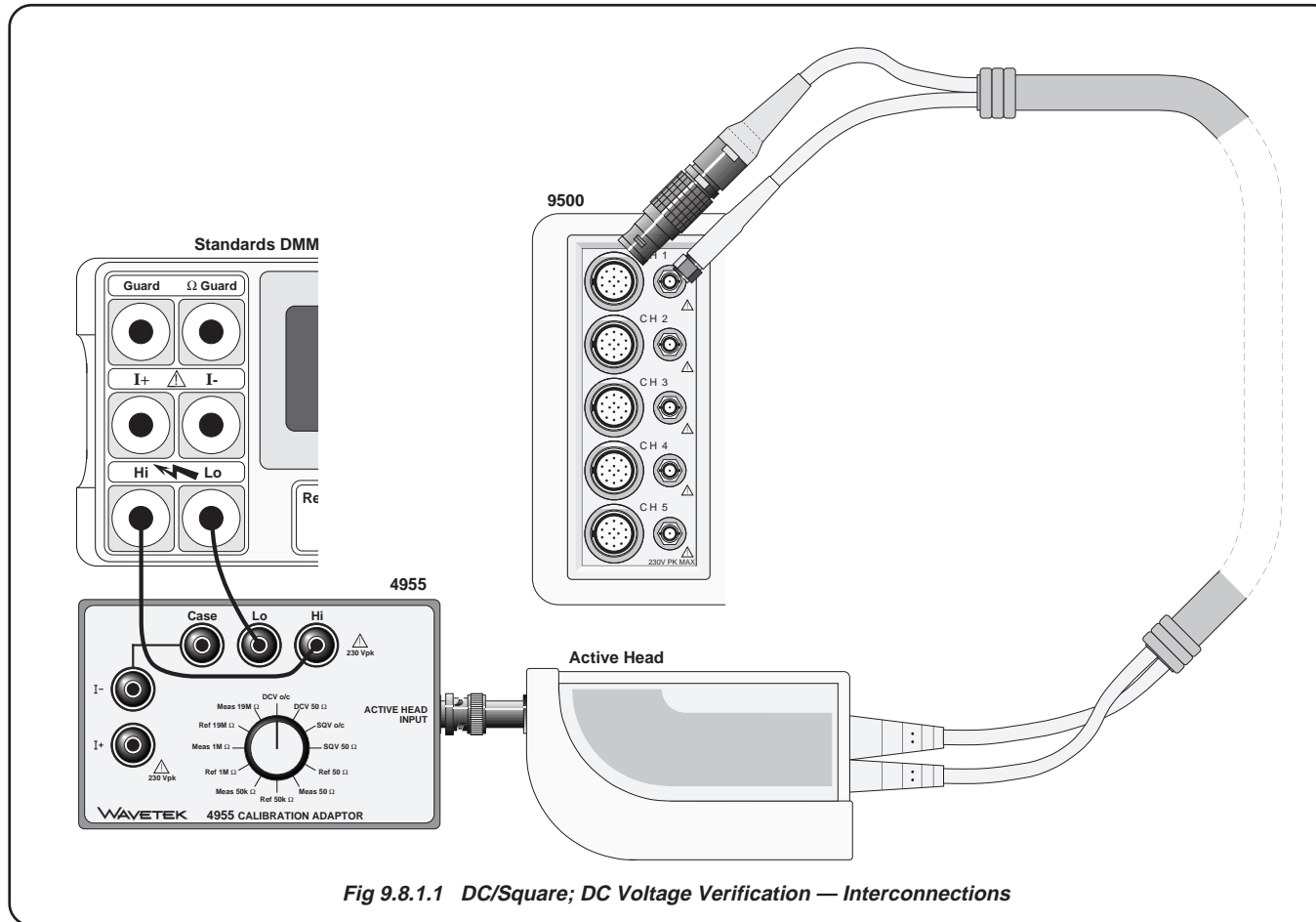

*Final Width = 215mm*

**Fig 9.8.1.1 DC/Square; DC Voltage Verification — Interconnections**

*Final Width = 215mm*

#### 9.8.1.4 Verification Setup

1. **Connections** Ensure that the 9500B is connected to the DMM as shown in *Fig. 9.8.1.1*, or via a similar BNC-4mm adaptor, and that both instruments are powered on and warmed up.
2. **9500B** Ensure that the 9500B is in MANUAL mode and then select the DC/Square; DC Voltage (Positive) function (from MANUAL mode entry default, press the WAVEFORM soft key and then press the  soft key on the right of the screen). Select the required output Signal Channel (1MΩ Load), trigger channel and Trigger Ratio (if required).

#### 9.8.1.5 Verification Procedure

Refer to *Tables 9.8.1.1* and *9.8.1.2*. Follow the correct sequence of verification points as shown on the tables, and carry out the following operations (1) to (6) at each verification point.

1. **DMM** Select the correct **DCV range** for the verification point Output Voltage.
2. **9500B** Set the **O/P Volts p-p** and **polarity** as required for the verification point:
3. **4955** If using the Model 4955 Calibration Adaptor, set its switch to **DCV o/c**. Otherwise ensure that the DMM input is at high impedance.
4. **9500B** Set Output **ON** and wait for the DMM reading to settle.
5. **Amplitude**
  - a. Measure the DCV output value.
  - b. Record this value in the **Measured Value** column of the *copy of the Table*.
  - c. Check that the **Measured Value** is at or between the **Absolute Tolerance Limits**.
6. **9500B** Set Output **OFF**.

**Table 9.8.1.1 — DC/Square DC (+) Verification into 1MΩ Load**

Please copy the following table.

Enter the measurements in the Measured Value column on the copy:

Verif. Point.	Output Voltage	Absolute Tolerance Limits (+DCV)		Measured Value
		Lower	Higher	
				
+DC1	1.0000mV	0.97475mV	1.02525mV	
+DC2	1.9000mV	1.87453mV	1.92547mV	
+DC3	2.3000mV	2.27443mV	2.32557mV	
+DC4	5.0000mV	4.97375mV	5.02625mV	
+DC5	6.0000mV	5.9735mV	6.0265mV	
+DC6	19.000mV	18.9703mV	19.0297mV	
+DC7	23.000mV	22.9693mV	23.0307mV	
+DC8	50.000mV	49.9625mV	50.0375mV	
+DC9	60.000mV	59.960mV	60.040mV	
+DC10	190.00mV	189.928mV	190.073mV	
+DC11	230.00mV	229.918mV	230.082mV	
+DC12	500.00mV	499.85mV	500.15mV	
+DC13	600.00mV	599.83mV	600.18mV	
+DC14	1.9000V	1.8995V	1.9005V	
+DC15	2.3000V	2.2994V	2.3006V	
+DC16	5.0000V	4.99873V	5.00127V	
+DC17	6.0000V	5.99848V	6.00152V	
+DC18	19.000V	18.99523V	19.00477V	
+DC19	23.000V	22.99423V	23.00577V	
+DC20	50.000V	49.98748V	50.01252V	
+DC21	60.000V	59.98498V	60.01502V	
+DC22	190.00V	189.9525V	190.0475V	

**Table 9.8.1.2 — DC/Square DC (-) Verification into 1MΩ Load**

Please copy the following table.

Enter the measurements in the Measured Value column on the copy:

Verif. Point.	Output Voltage	Absolute Tolerance Limits (-DCV)		Measured Value
		Lower	Higher	
-DC1	1.0000mV	0.97475mV	1.02525mV	
-DC2	1.9000mV	1.87453mV	1.92547mV	
-DC3	2.3000mV	2.27443mV	2.32557mV	
-DC4	5.0000mV	4.97375mV	5.02625mV	
-DC5	6.0000mV	5.9735mV	6.0265mV	
-DC6	19.000mV	18.9703mV	19.0297mV	
-DC7	23.000mV	22.9693mV	23.0307mV	
-DC8	50.000mV	49.9625mV	50.0375mV	
-DC9	60.000mV	59.960mV	60.040mV	
-DC10	190.00mV	189.928mV	190.073mV	
-DC11	230.00mV	229.918mV	230.082mV	
-DC12	500.00mV	499.85mV	500.15mV	
-DC13	600.00mV	599.83mV	600.18mV	
-DC14	1.9000V	1.8995V	1.9005V	
-DC15	2.3000V	2.2994V	2.3006V	
-DC16	5.0000V	4.99873V	5.00127V	
-DC17	6.0000V	5.99848V	6.00152V	
-DC18	19.000V	18.99523V	19.00477V	
-DC19	23.000V	22.99423V	23.00577V	
-DC20	50.000V	49.98748V	50.01252V	
-DC21	60.000V	59.98498V	60.01502V	
-DC22	190.00V	189.9525V	190.0475V	

*Final Width = 215mm*

*Final Width = 215mm*

---

## 9.8.2 Verifying the DC/Square Function: Square Voltage

### 9.8.2.1 Summary

Equipment requirements are given at *para 9.8.2.2* and test interconnections at *para 9.8.2.3*.

The Square Function is verified by carrying out measurements of amplitude in the sequence given at *para 9.8.2.4*, at the verification points shown in *Tables 9.8.2.1, 9.8.2.2* and *9.8.2.3*.

### 9.8.2.2 Equipment Requirements

- The UUT Model 9500B Mainframe, with 9510 or 9530 Active Head.
- A high resolution Standards DMM with RMS AC Voltage accuracy of  $\pm 0.01\%$  or better, from 2.5mV to 35V, at 1kHz.  
*Example: Model 1281 Digital Multimeter.*
- An adaptor to convert from BNC to 4mm leads.  
*Example: Model 4955 Calibration Adaptor.*
- Short, high-quality 4mm leads.

### 9.8.2.3 Interconnections

Refer to *Fig 9.8.2.1* opposite.

### 9.8.2.4 Verification Setup

1. **Connections** Ensure that the 9500B is connected to the DMM as shown in *Fig. 9.8.2.1*, or via a similar BNC-4mm adaptor, and that both instruments are powered on and warmed up.
2. **9500B** Ensure that the 9500B is in MANUAL mode and then select the DC/Square; Square (Positive) function (MANUAL mode entry default or  soft key). Select the required output Signal Channel (1M $\Omega$  Load), trigger channel and Trigger Ratio (if required).



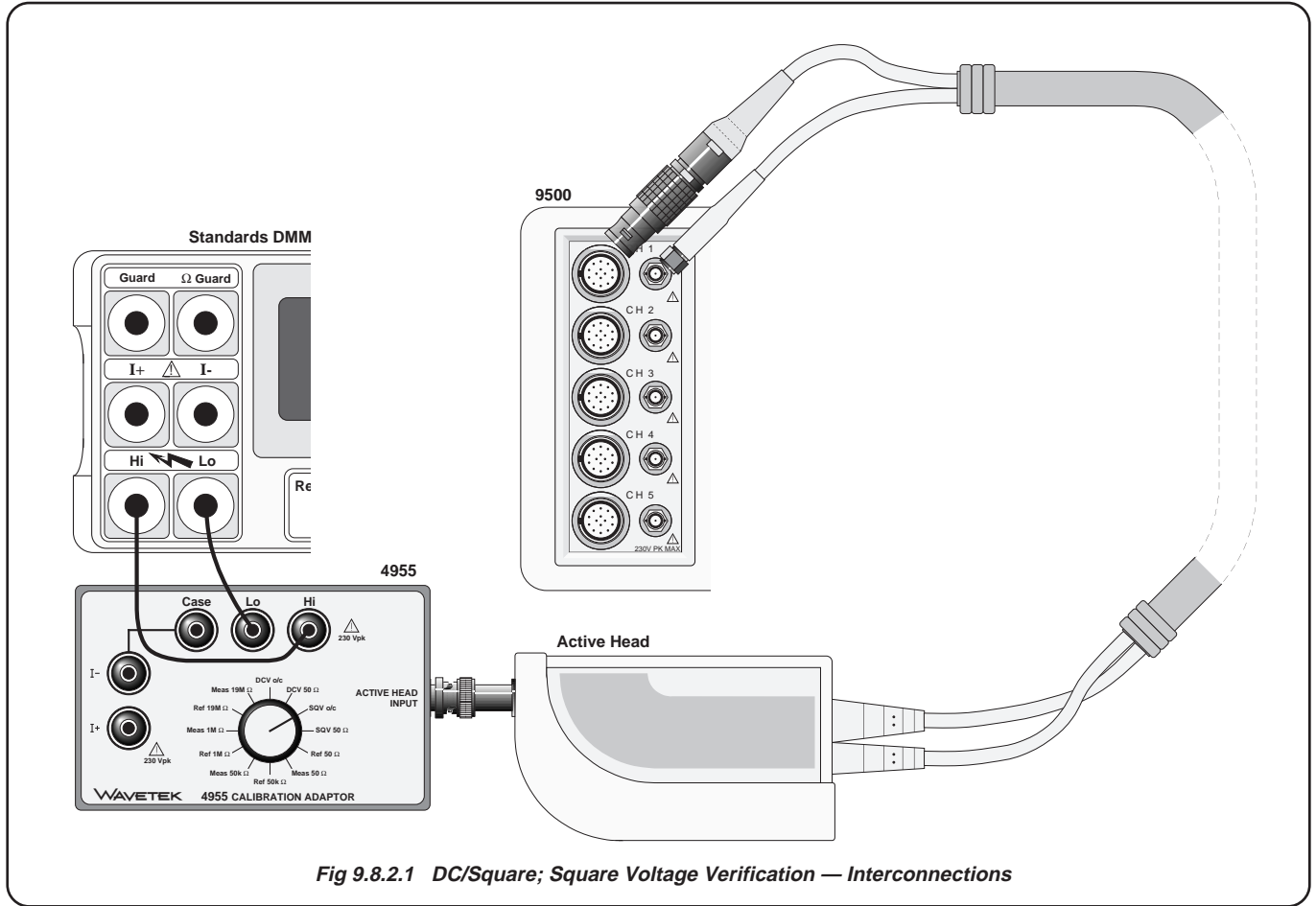



**Fig 9.8.2.1 DC/Square; Square Voltage Verification — Interconnections**

*Final Width = 215mm*

*Continued overleaf→*

### 9.8.2.5 Verification Procedure

Copy the three tables: 9.8.2.1, 9.8.2.2 and 9.8.2.3. Follow the correct sequence of verification points as shown on the tables, and carry out the following operations at each verification point.

1. **Verification Points** Refer to *Table 9.8.2.1*.
2. **DMM** Select the correct **RMS Voltage range** for the verification point RMS Output Voltage.
3. **9500B** Set the **O/P Volts p-p** and **waveform** as required for the verification point:
4. **4955** If using the Model 4955 Calibration Adaptor, set its switch to 'SQV o/c'. If not using the Model 4955, ensure that the DMM input is AC-coupled at high impedance.
5. **9500B** Set Output **ON** and wait for the DMM reading to settle.
6. **Amplitude**
  - a. Measure the RMS Output Voltage value.
  - b. Record this value in the **Measured Value** column of the *copy of the Table*.
  - c. Check that the **Measured Value** is at or between the **Absolute Tolerance Limits**.
7. **9500B** Set Output **OFF**.
8. Press the WAVEFORM soft key. Select Square (negative) by pressing the  key on the right of the screen. Repeat steps (2) to (7), but using *Table 9.8.2.2* for each of the verification points.
9. Press the WAVEFORM soft key. Select Square (symmetrical) by pressing the  key on the right of the screen. Repeat steps (2) to (7), but using *Table 9.8.2.3* for each of the verification points.

**N.B.** For Operation (6), the RMS Output Voltage values, and RMS Absolute Tolerance Limits have been derived using the following factor for the output waveform:

$$\text{(at 1kHz: RMS} = 0.5 \times 0.999917 \times \text{pk-pk)}$$

**Note:** This factor applies only at 1kHz and assumes use of model 4955 set to 'SQV o/c'. A compensation of 83ppm accounts the finite transition time of the Square Wave and the resultant fall in its RMS value.

*Final Width = 215mm*

**Table 9.8.2.1 DC/Square Square (+) Verification at 1kHz into 1MΩ Load**

Please copy the following table.

Enter the measurements in the **Measured Value** column on the copy:

Verif. Point. 	Frequency	Output Voltage (pk-pk)	Absolute Tolerance Limits (pk-pk)		Output Voltage (RMS)	Absolute Tolerance Limits (RMS)		Measured Value (RMS)
			Lower	Higher		Lower	Higher	
+SQ1	1kHz	600.00mV	599.39mV	600.61mV	299.9979mV	299.67mV	300.28mV	
+SQ2	1kHz	60.000mV	59.93mV	60.07mV	29.99799mV	29.96mV	30.03mV	
+SQ3	1kHz	6.0000mV	5.984mV	6.016mV	2.999799mV	2.992mV	3.008mV	
+SQ4	1kHz	6.0000V	5.99399V	6.00601V	2.999799V	2.99674V	3.00275V	
+SQ5	1kHz	60.000V	59.93999V	60.06001V	29.99799V	29.96750V	30.02751V	

**Table 9.8.2.2 DC/Square Square (-) Verification at 1kHz into 1MΩ Load**

Please copy the following table.

Enter the measurements in the **Measured Value** column on the copy:

Verif. Point. 	Frequency	Output Voltage (pk-pk)	Absolute Tolerance Limits (pk-pk)		Output Voltage (RMS)	Absolute Tolerance Limits (RMS)		Measured Value (RMS)
			Lower	Higher		Lower	Higher	
-SQ1	1kHz	600.00mV	599.39mV	600.61mV	299.9979mV	299.67mV	300.28mV	
-SQ2	1kHz	60.000mV	59.93mV	60.07mV	29.99799mV	29.96mV	30.03mV	
-SQ3	1kHz	6.0000mV	5.984mV	6.016mV	2.999799mV	2.992mV	3.008mV	
-SQ4	1kHz	6.0000V	5.99399V	6.00601V	2.999799V	2.99674V	3.00275V	
-SQ5	1kHz	60.000V	59.93999V	60.06001V	29.99799V	29.96750V	30.02751V	

*Final Width = 215mm*

**Table 9.8.2.3 DC/Square Square (Symmetrical) Verification at 1kHz into 1MΩ Load**

Please copy the following table.

Enter the measurements in the **Measured Value** column on the copy:

Verif. Point. 	Frequency	Output Voltage (pk-pk)	Absolute Tolerance Limits (pk-pk)		Output Voltage (RMS)	Absolute Tolerance Limits (RMS)		Measured Value (RMS)
			Lower	Higher		Lower	Higher	
±SQ1	1kHz	600.00mV	599.39mV	600.61mV	299.9979mV	299.67mV	300.28mV	
±SQ2	1kHz	60.000mV	59.93mV	60.07mV	29.99799mV	29.96mV	30.03mV	
±SQ3	1kHz	6.0000mV	5.984mV	6.016mV	2.999799mV	2.992mV	3.008mV	
±SQ4	1kHz	6.0000V	5.99399V	6.00601V	2.999799V	2.99674V	3.00275V	
±SQ5	1kHz	60.000V	59.93999V	60.06001V	29.99799V	29.96750V	30.02751V	

*Final Width = 215mm*

---

### 9.8.3 Verifying the LF Sine Voltage Function

#### 9.8.3.1 Summary

Equipment requirements are given at *para 9.8.3.2* and test interconnections at *para 9.8.3.3*.

The LF Sine Voltage Function is verified by carrying out measurements of amplitude in the sequence given at *para 9.8.3.4*, at the verification points shown in *Table 9.8.3.1*.

#### 9.8.3.2 Equipment Requirements

- The UUT Model 9500B Mainframe, with 9510 or 9530 Active Head.
- A high resolution Standards DMM with RMS AC Voltage accuracy of  $\pm 0.3\%$  or better, between 0.5V and 2V, at 1kHz and 45kHz.  
*Example: Model 1281 Digital Multimeter.*
- An adaptor to convert from BNC to 4mm leads.  
*Example: Model 4955 Calibration Adaptor.*
- Short, high-quality 4mm leads.

#### 9.8.3.3 Interconnections

Refer to *Fig 9.8.3.1* opposite.

#### 9.8.3.4 Verification Setup

1. **Connections** Ensure that the 9500B is connected to the DMM as shown in *Fig. 9.8.3.1*, or via a similar BNC-4mm adaptor, and that both instruments are powered on and warmed up.
2. **9500B** Ensure that the 9500B is in MANUAL mode and then select the Sine function ( key). Select the required output Signal Channel (50 $\Omega$  Load), trigger channel and Trigger Ratio (if required).

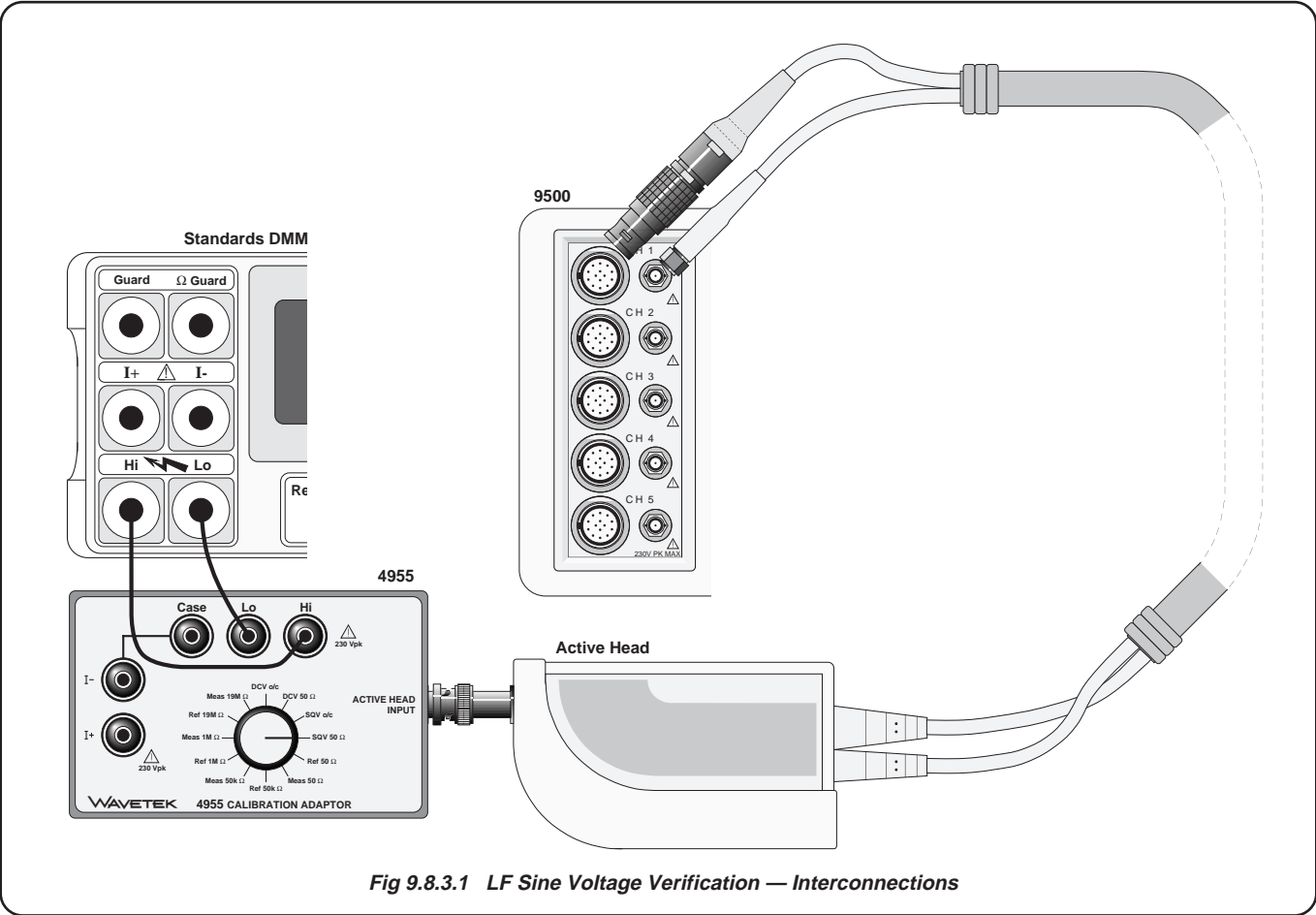

*Final Width = 215mm*

**Fig 9.8.3.1 LF Sine Voltage Verification — Interconnections**

*Continued overleaf→*

### 9.8.3.5 Verification Procedure

Copy the table: 9.8.3.1. Follow the correct sequence of verification points as shown on the table, and carry out the following operations (1) to (7) at each verification point.

- |   |   |
|---|---|
| <p><b>1. Verification Points</b> Refer to <i>Table 9.8.3.1</i>.</p> <p><b>2. DMM</b> Select the correct <b>RMS Voltage range</b> for the verification point RMS Output Voltage.</p> <p><b>3. 9500B</b> Set the <b>Output Volts p-p</b> as required for the verification point:</p> <p><b>4. 4955</b> If using the Model 4955 Calibration Adaptor, set its switch to 'SQV 50Ω'. If not using the Model 4955, ensure that the DMM input is AC-coupled at 50Ω input impedance.</p> <p><b>5. 9500B</b> Set Output <b>ON</b> and wait for the DMM reading to settle.</p> | <p><b>N.B.</b> For Operation (6), the RMS Output Voltage values, and RMS Absolute Tolerance Limits have been derived using the following factor for the output waveform:<br/>(at 1kHz: <math>RMS = 0.5 \times 0.707106781 \times pk-pk</math>)</p> <p><b>Note:</b> This factor applies only when the Standards DMM input is AC-Coupled through a large capacitance. It is based on the use of a model 4955 set to 'SQV 50Ω'.</p> <p><b>6. Amplitude</b></p> <ul style="list-style-type: none"> <li>a. Measure the RMS Output Voltage value.</li> <li>b. Record this value in the <b>Measured Value</b> column of the <i>copy of the Table</i>.</li> <li>c. Check that the <b>Measured Value</b> is at or between the <b>Absolute Tolerance Limits</b>.</li> </ul> <p><b>7. 9500B</b> Set Output <b>OFF</b>.</p> |
|---|---|

*Final Width = 215mm*

**Table 9.8.3.1 Sine Verification into 50Ω Load**

Please copy the following table.

Enter the measurements in the **Measured Value** column on the copy:

Verif. Point. 	Frequency	Output Voltage (pk-pk)	Absolute Tolerance Limits (pk-pk)		Output Voltage (RMS)	Absolute Tolerance Limits (RMS)		Measured Value (RMS)
			Lower	Higher		Lower	Higher	
SIN1	1kHz	4.8000V	4.632V	4.968V	1.69706V	1.6377V	1.7565V	
SIN2	45kHz	4.8000V	4.632V	4.968V	1.69706V	1.6377V	1.7565V	
SIN3	1kHz	1.9000V	1.8335V	1.9665V	0.67175V	0.6482V	0.6953V	
SIN4	45kHz	1.9000V	1.8335V	1.9665V	0.67175V	0.6482V	0.6953V	

## 9.8.4 Verifying the Time Markers Function

### 9.8.4.1 Summary

Equipment requirements are given at *para 9.8.4.2* and test interconnections at *para 9.8.4.3*.

The Time Markers Function is verified by carrying out measurements of Period in the sequence given at *paras 9.8.4.5*, at the verification points shown in *Table 9.8.4.1*.

### 9.8.4.2 Equipment Requirements

- The UUT Model 9500B Mainframe, with 9510 or 9530 Active Head.
- Digital counter for 0.25ppm clock accuracy measurements.

*Example: Hewlett Packard Model HP53131A with Option 012.*

### 9.8.4.3 Interconnections

Refer to *Fig 9.8.4.1*.

### 9.8.4.4 Verification Setup

- 1. Connections** Connect the 9500B to the Counter as shown in *Para 9.8.4.1*, and ensure that both instruments are powered ON and warmed up.
- 2. Counter** Select the required function to measure period.
- 3. 9500B**
  - a. Ensure that the 9500B is in MANUAL mode and then select the Time Markers function (**↓↓↓** key).
  - b. Use the bottom soft key on the right of the screen, highlighting 1/f (f  $\frac{1}{f}$ ), to view output **Period** on the screen.
  - c. Select the required output Signal Channel (50 $\Omega$  or 1M $\Omega$  Load as required), trigger channel and Trigger Ratio (if required).

*Verification Procedure and table overleaf→*

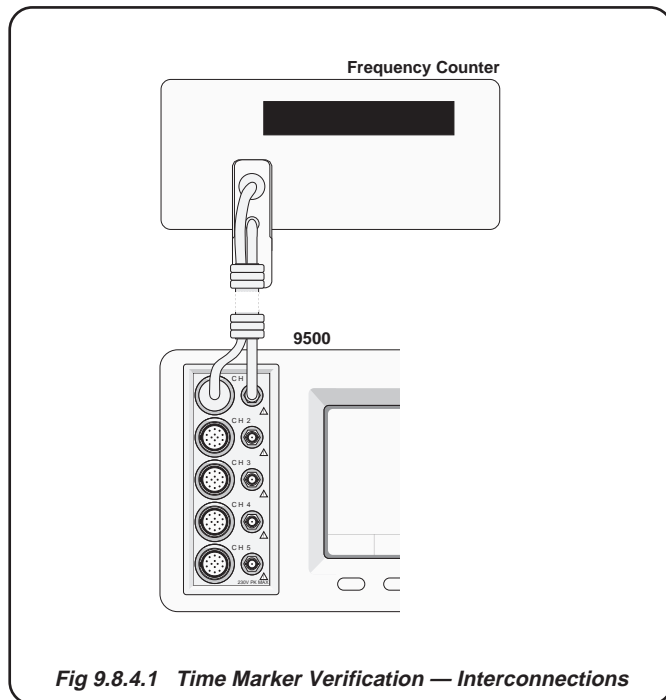

*Final Width = 215mm*

### 9.8.4.5 Verification Procedure

Copy the table 9.8.4.1. Follow the correct sequence of verification points as shown on the table, and carry out the following operations (1) to (5) at each verification point.

1. **Verification Points** Refer to *Table 9.8.4.1*.
2. **Counter** Select the correct display time, trigger source and level to measure at the verification point.
3. **9500B** Set the **Time Marker period** as required for the verification point, and set Output ON.
4. **Counter** Adjust the trigger level for a stable display, measure and note the output period.
5. **9500B** Set Output **OFF**.

**Table 9.8.4.1 Time Markers Verification at 1Vpk-pk Output**

Please copy the following table. Enter the measurements in the appropriate **Measured Period** column on the copy:

Verif. Point. 	Time Marker Period	Absolute Tolerance Limits ( $\pm 0.25\text{ppm}$ )		Measured Period
		Lower	Higher	
<b>MKR1</b>	10.000ns (sqr)	9.9999975ns	10.0000025ns	
<b>MKR2</b>	100.00ns (sqr)	99.999975ns	100.000025ns	
<b>MKR3</b>	1.0000 $\mu$ s (sqr)	0.9999975 $\mu$ s	1.0000025 $\mu$ s	
<b>MKR4</b>	1.0000ms (sqr)	0.9999975ms	1.0000025ms	
<b>MKR5</b>	10.000ms (sqr)	9.999975ms	10.000025ms	

*Final Width = 215mm*



---

## 9.8.5 Verifying the Load Resistance Measurement Function

### 9.8.5.1 Summary

Equipment requirements are given at *para 9.8.5.2* and test interconnections at *para 9.8.5.3*.

The Load Resistance Measurement Function is verified by carrying out measurements of Reference Resistors in the sequence given at *paras 9.8.5.5*, at the verification points shown in *Table 9.8.5.1*.



### 9.8.5.2 Equipment Requirements

- The UUT Model 9500B with 9510 or 9530 Active Head.
- A traceable, high-resolution Standards DMM, used to measure resistance at  $1\text{M}\Omega$  and  $50\Omega$ , with an accuracy of 0.02% or better. For example, a Model 1281 Digital Multimeter.
- An adaptor to convert from BNC to 4mm leads, incorporating switchable  $50\Omega$ , and  $1\text{M}\Omega$  reference loads. For example, a Model 4955 Calibration Adaptor.
- Short, high-quality 4mm leads.

### 9.8.5.3 Interconnections

Refer to *Fig 9.8.5.1 (overleaf)*.

### 9.8.5.4 Verification Setup

1. **Connections** Ensure that the 9500B is connected to the Standards DMM as shown in *Fig. 9.8.5.1*, or via a similar BNC-4mm adaptor and  $50\Omega$  load, and that both instruments are powered on and warmed up.
2. **9500B**
  - a. Ensure that the 9500B is in MANUAL mode and then select the Load Resistance Measurement function (From entry default, press the **Aux** key on the right of the Front Panel, then the  soft key at the bottom left of the screen).
  - b. In the  Menu, select the required output Signal Channel via the **Channel Selection** screen.  
*Verification Procedure and table overleaf*→

*Final Width = 215mm*

*Final Width = 215mm*

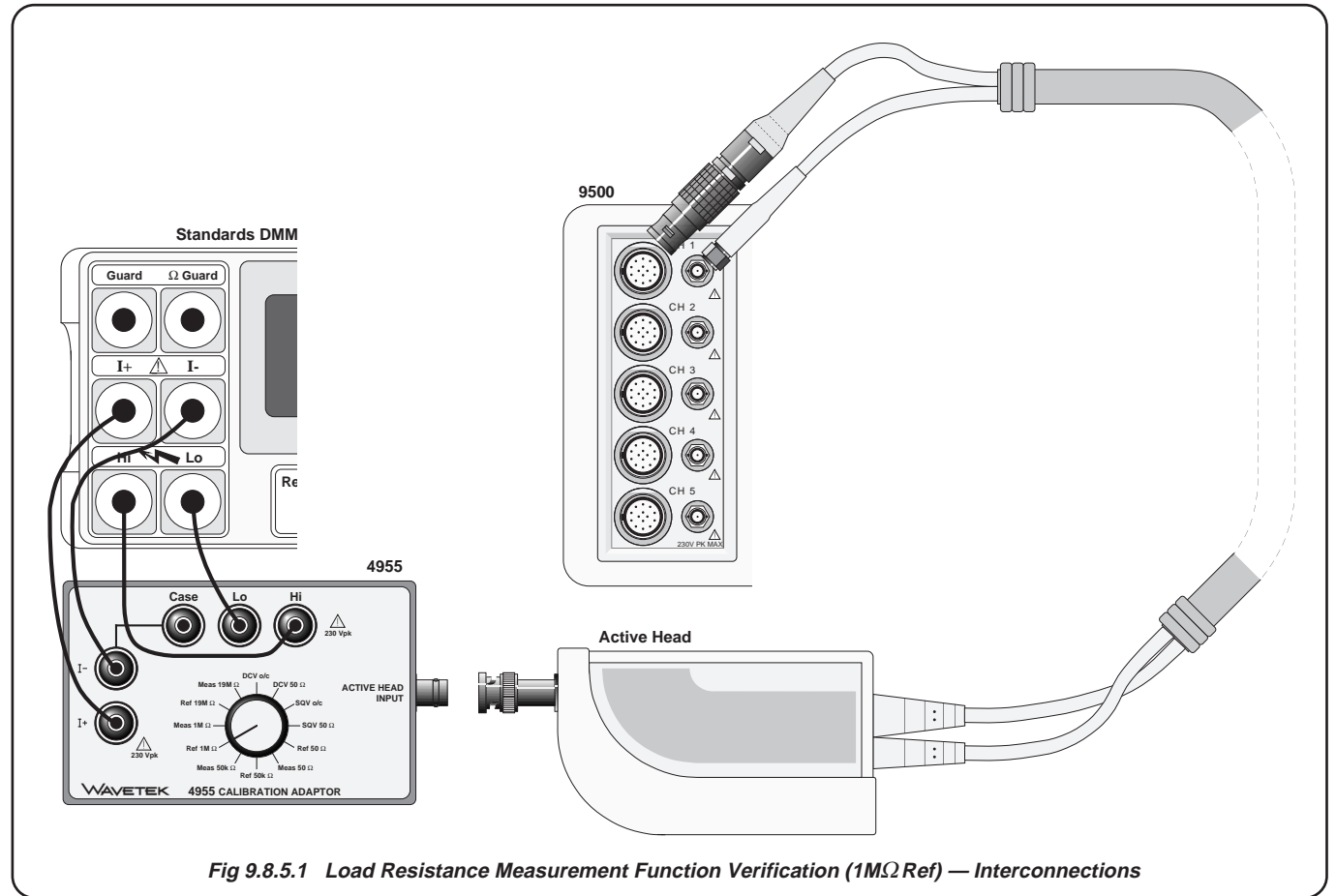

**Fig 9.8.5.1 Load Resistance Measurement Function Verification (1M $\Omega$  Ref) — Interconnections**

### 9.8.5.5 Verification Procedure

Copy the table: 9.8.5.1. Follow the correct sequence of verification points as shown on the table, and carry out the following operations (1) to (10) at each verification point.

1. **Verification Points** Refer to *Table 9.8.5.1*.
2. **9500B** Ensure that OUTPUT is OFF.
3. If using the Model 4955 Calibration Adaptor:
  - a) Ensure that the Active Head output BNC is disconnected from the Model 4955 input.
  - b) Set the Model 4955 Calibration Adaptor switch as shown in *Table 9.8.5.1*.
4. If not using the Model 4955, set up external circuitry to measure the appropriate load resistor (4-wire connection), with the 9500B Active Head output BNC disconnected.
5. **DMM** Set to the appropriate Resistance measurement range, take a Resistance measurement and note the result (**R ref**) in *Table 9.8.5.1*.  
Note: Make sure to allow for any settling time of the external measuring instrument.
6. Calculate the lower and higher absolute tolerance limit values:  
**Lower limit:** (L lim) = R ref - (R ref x 0.001)  
**Higher limit:** (H lim) = R ref + (R ref x 0.001)  
 Enter **L lim** and **H lim** into the appropriate columns in *Table 9.8.5.1*.
7. If using the Model 4955 Calibration Adaptor:
  - a) Set the Model 4955 Calibration Adaptor switch as shown in *Table 9.8.5.1*.
  - b) Reconnect the Active Head output BNC to the Model 4955 input.
8. If not using the Model 4955, disconnect the load resistor from the DMM, and reconnect it to the 9500B Active Head output BNC.
9. Press the **ON** key to turn the 9500B output on.
10. Using the 9500B, take a Resistance measurement and note the result (**R meas**) in *Table 9.8.5.1*.
11. 9500B Set OUTPUT OFF.

*Final Width = 215mm*

**Table 9.8.5.1 Load Resistance Measurement Verification**

Please copy the following table. Enter the measurements on the copy as described in the procedure:

Verif. Point.	4955 Switch Position Op. 3 (b)	Resistance Value Measured by DMM (Rref)	Calculated Absolute Tolerance Limits		4955 Switch Position Op. 7 (a)	Resistance Value Measured by 9500B (Rmeas)
			Lower (L lim)	Higher (H lim)		
RES1	Ref 1M Ω				Meas 1M Ω	
RES2	Ref 50 Ω				Meas 50 Ω	

## 9.8.6 Verifying the Pulse Width Function

### 9.8.6.1 Summary

Equipment requirements are given at *para 9.8.6.2* and test interconnections at *para 9.8.6.3*.

The Pulse Width Function is verified by carrying out measurements of Period in the sequence given at *paras 9.8.6.5*, at the verification points shown in *Table 9.8.6.1*.

### 9.8.6.2 Equipment Requirements

- The UUT Model 9500B Mainframe, with 9510 or 9530 Active Head.
- Digital counter for 0.25ppm clock accuracy measurements.

*Example: Hewlett Packard Model HP53131A with Option 012.*

### 9.8.6.3 Interconnections

Refer to *Fig 9.8.6.1*.

### 9.8.6.4 Verification Setup

- 1. Connections** Connect the 9500B to the Counter as shown in *Para 9.8.4.1*, and ensure that both instruments are powered ON and warmed up.
- 2. Counter** Select the required function to measure pulse duration and reading average to enhance measurement resolution.
- 3. 9500B**
  - a. Ensure that the 9500B is in MANUAL mode and then select the Pulse Width function.
  - b. Select the required output Signal Channel (50Ω load).

*Verification Procedure and table overleaf→*

*Final Width = 215mm*

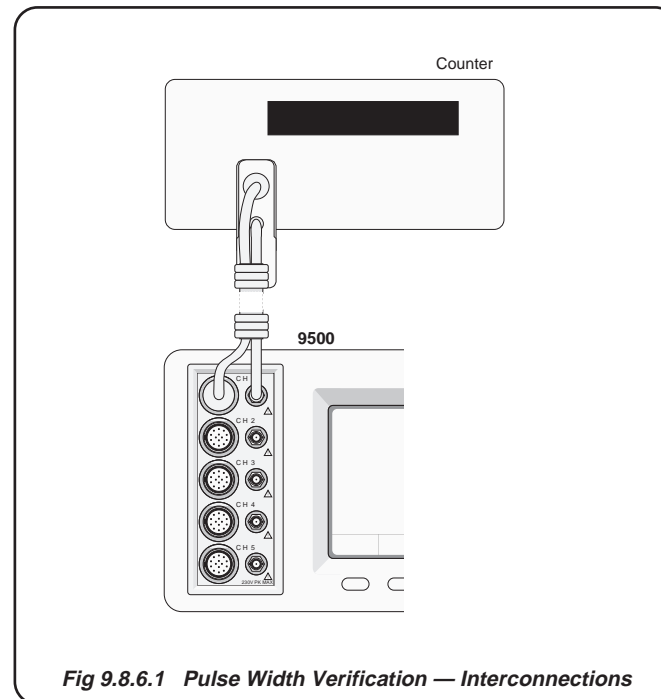

**Fig 9.8.6.1 Pulse Width Verification — Interconnections**

### 9.8.6.5 Verification Procedure

Copy the table 9.8.6.1. Follow the correct sequence of verification points as shown on the table, and carry out the following operations (1) to (5) at each verification point.

1. **Verification Points** Refer to *Table 9.8.6.1*.
2. **Counter** Select the correct display time, trigger source and level to measure at the verification point.
3. **9500B** Set the **Pulse Width Duration** as required for the verification point, and set Output ON.
4. **Counter** Adjust the trigger level for a stable display, measure and note the output period.
5. **9500B** Set Output **OFF**.

**Table 9.8.6.1 Pulse Width Verification at 1Vpk-pk Output**

Please copy the following table. Enter the measurements in the appropriate **Measured Period** column on the copy:

Verif. Point. 	Pulse Width Duration	Absolute Tolerance Limits ( $\pm 5\% \pm 200\text{ps}$ )		Measured Duration
		Lower	Higher	
PW1	4.000ns	3.600ns	4.400ns	
PW2	20.000ns	18.800ns	21.200ns	
PW3	100.00ns	95.20ns	105.20ns	

*Final Width = 215mm*

---

## 9.9 9510/9530/9550/9560 Head Verification by Functions

Sub-section 9.9 is a guide to the process of verifying the Model 9560, 9550, 9530, and 9510 Heads functions from the front panel. The following topics are covered:

- 9.9.1 Levelled Sine Function: LF Gain
- 9.9.2 Levelled Sine Function: Flatness
- 9.9.3 Edge Function
- 9.9.4 Load Capacitance Measurement Function

The list of topics above are placed in the order in which the 9500B Head functions should be verified. Although it is not essential to verify all the functions at any one time, functions higher in the list should be verified before those lower in the list.

Head verification involves the use of a verified 9500B Mainframe.

**Note:** Heads can be verified only within the bandwidth of the mainframe.

- e.g. Head Model 9510 with Mainframe Variant 9500B/600 can only be verified to 600MHz.

### 9.9.1 Verifying the Levelled Sine Function: LF Gain

#### 9.9.1.1 Summary

Equipment requirements are given at *para 9.9.1.2* and test interconnections at *para 9.9.1.3*.

The Levelled Sine Function is verified by carrying out measurements of amplitude at frequencies of 1kHz, 45kHz and 50kHz; in the sequences given at *para 9.9.1.4 and 9.9.1.5*, at the verification points shown in *Table 9.9.1.1*.

#### 9.9.1.2 Equipment Requirements

- The UUT Active Head, connected to a verified Model 9500B Mainframe (refer to *Sub-section 9.8.3*).
- A high resolution Standards DMM with RMS AC Voltage accuracy of 0.3% or better, from 10mV to 1.5V, at 1kHz, 45kHz and 50kHz. *Example: Model 1281 Digital Multimeter.*
- An adaptor to convert from PC3.5 or BNC to 4mm leads. *Example: Model 4955 Calibration Adaptor and PC3.5 to BNC adaptor.*
- Short, high-quality 4mm leads for connection between the Calibration Adaptor the DMM.

Final Width = 215mm

### 9.9.1.3 Interconnections

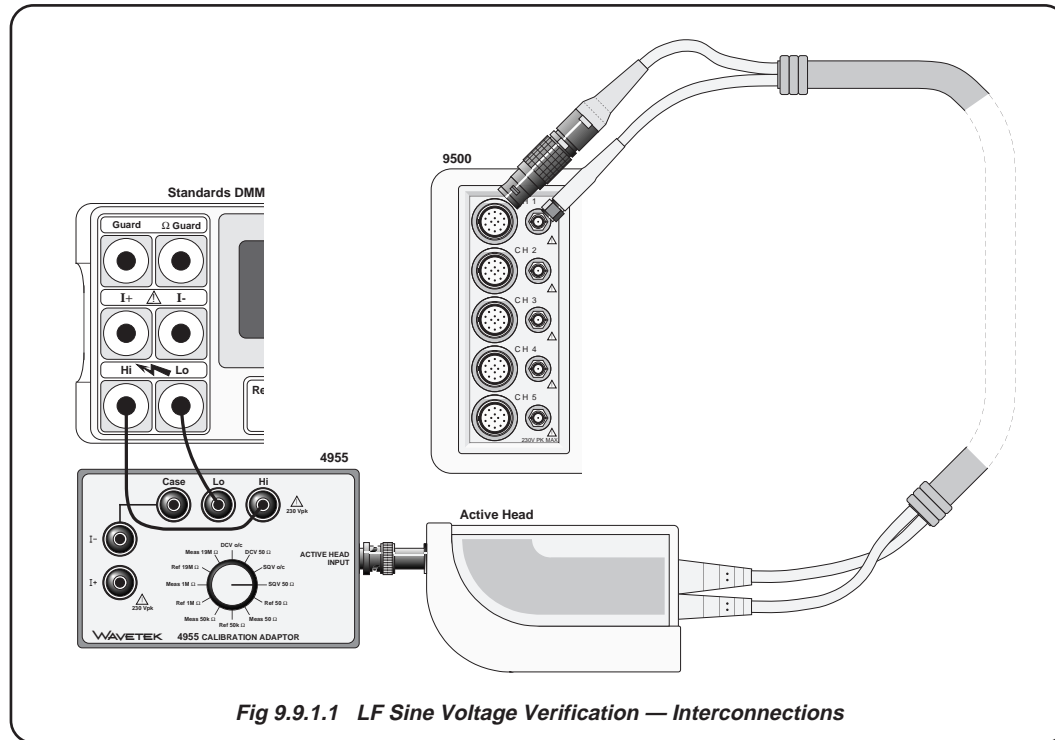

Fig 9.9.1.1 LF Sine Voltage Verification — Interconnections

*Final Width = 215mm*

### 9.9.1.4 Verification Setup

- 1. Connections** Ensure that the 9500B is connected to the DMM as shown in Fig. 9.9.1.1, or via a similar PC3.5 or BNC-4mm adaptor, and that both instruments are powered on and warmed up.
- 2. 9500B** Ensure that the 9500B is in MANUAL mode and then select the Sine function (⌚ key). Select the required output Signal Channel (50Ω Load).

### 9.9.1.5 Verification Procedure

Copy the table: 9.9.1.1. Follow the correct sequence of verification points as shown on the table, and carry out the following operations (1) to (7) at each verification point.

1. **Verification Points** Refer to *Table 9.9.1.1*.
2. **DMM** Select the correct **RMS Voltage range** for the verification point RMS Output Voltage.
3. **9500B** Set the **Output Volts p-p** as required for the verification point:
4. **4955** If using the Model 4955 Calibration Adaptor, set its switch to 'SQV 50 Ω'. If not using the Model 4955, ensure that the DMM input is AC-coupled at 50 input impedance.
5. **9500B** Set Output **ON** and wait for the DMM reading to settle.
- N.B.** For Operation (6), the RMS Output Voltage values, and RMS Tolerance Limits have been derived using the following factor for the output waveform:  
(at 1kHz:  $RMS = 0.5 \times 0.707107 \times pk-pk$ )  
**Note:** This factor applies only when the Standards DMM input is AC-Coupled through a large capacitance. It is based on the use of a model 4955 set to 'SQV 50 Ω'.
6. **Amplitude**
  - a. Measure the RMS Output Voltage value.
  - b. Record this value in the **Measured Value** column of the *copy of the Table*.
  - c. For SGN1-6 calculate and record the **Calculated Values** in the *copy of the table*.
  - d. For SGN1-6 check that the **Calculated Value** is at or between the **RMS Tolerance Limits**.
  - e. For SGN7-11 check that the **Measured Value** is at or between the **RMS Tolerance Limits**.
7. **9500B** Set Output **OFF**.

**Table 9.9.1.1 Sine Verification into 50 Ω Load**

Please copy the following table. Enter the measurements in the **Measured Value** column on the copy and calculate as shown:

*Final Width = 215mm*

Verif. Point. 	Freq.	Output Voltage (pk-pk)	Tolerance Limits (pk-pk)		Output Voltage (RMS)	Tolerance Limits (RMS)		Measured Value (RMS)	Calculated Value
			Lower	Higher		Lower	Higher		
<b>SGN1</b>	1kHz	1.0000V	-0.015V	0.015V	0.35355V	-5.3mV	5.3mV		SGN8-SGN1
<b>SGN2</b>	1kHz	300.00mV	-4.5mV	4.5mV	106.066mV	-1.59mV	1.59mV		SGN9-SGN2
<b>SGN3</b>	1kHz	100.00mV	-1.5mV	1.5mV	35.3553mV	-0.53mV	0.53mV		SGN10-SGN3
<b>SGN4</b>	45kHz	1.0000V	-0.015V	0.015V	0.35355V	-5.3mV	5.3mV		SGN8-SGN4
<b>SGN5</b>	45kHz	300.00mV	-4.5mV	4.5mV	106.066mV	-1.59mV	1.59mV		SGN9-SGN5
<b>SGN6</b>	45kHz	100.00mV	-1.5mV	1.5mV	35.3553mV	-0.53mV	0.53mV		SGN10-SGN6
<b>SGN7</b>	50kHz	3.0000V	2.955V	3.045V	1.06066V	1.04475V	1.07657V		NA
<b>SGN8</b>	50kHz	1.0000V	0.985V	1.015V	0.35355V	0.34825V	0.35885V		NA
<b>SGN9</b>	50kHz	300.00mV	295.5mV	304.5mV	106.066mV	104.475mV	107.657mV		NA
<b>SGN10</b>	50kHz	100.00mV	98.50mV	101.5mV	35.3553mV	34.8250mV	35.8856mV		NA
<b>SGN11</b>	50kHz	30.000mV	29.55mV	30.45mV	10.6066mV	10.4475mV	10.7657mV		NA



## 9.9 9530/9560/9550/9510 Head Verification by Functions (Contd.)

### 9.9.2 Verifying the Levelled Sine Function: Flatness

#### 9.9.2.1 Summary

Equipment requirements are given at *para 9.9.2.2* and test interconnections at *para 9.9.2.3*. *Para 9.9.2.4* shows the Verification Setup.

The Verification Procedure is at *para 9.9.2.5*, A short description of Calculating Validity Tolerances is given at *para 9.9.2.6*, and the final Uncertainty Calculation and Flatness Check is at *para 9.9.2.7*.

The Levelled Sine Function is verified by carrying out measurements of amplitude at frequencies between 50kHz and 6.4GHz; in the sequences given at *para 9.9.2.5*, at the verification points shown in *Tables 9.9.2.1, 9.9.2.2, 9.9.2.3 and 9.9.2.4*.

**Note:** Heads can be verified only within the bandwidth of the mainframe. e.g. Head Model 9510 with Mainframe Variant 9500B/600 can only be verified to 600MHz.

#### 9.9.2.2 Equipment Requirements

- The UUT Active Head, connected to a verified Model 9500B Mainframe (for Mainframe verification, refer to *Sub-section 9.8.3*).
- RF Power Meter for Power measurements from 50kHz and 6.4GHz and from 100mVp-p to 3Vp-p into 50Ω.

Examples: *Marconi Instruments Model 6960B with Model 6912 head up to 1.1GHz or Rhode and Schwarz NRVS with NRV-Z5 head beyond 1.1GHz.*

- Precision-N to BNC Adaptor for signal connection from the UUT Active Head to the input of the RF Power Meter head for Amplitude measurements.

Example: *Huber & Suhner Adapter type no. 31BNC-N-50-51 or 31N-PC3.5-50-1.*

#### 9.9.2.3 Interconnections

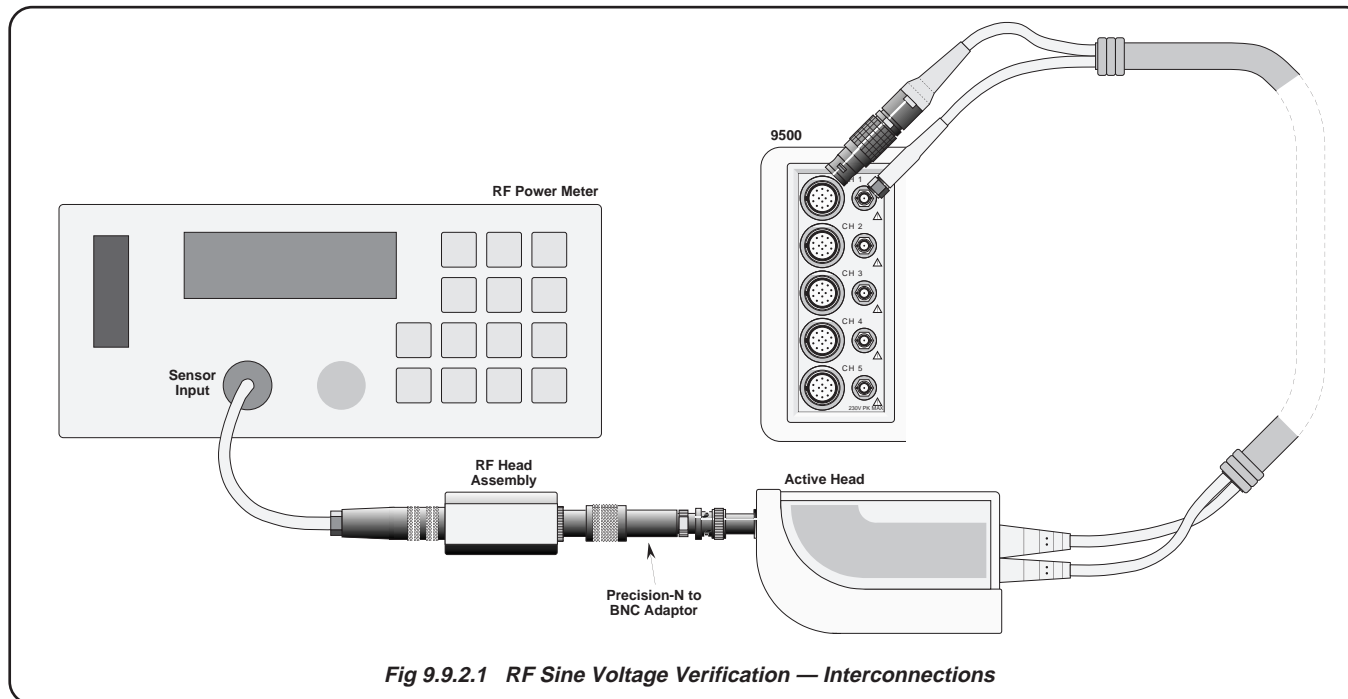

**Fig 9.9.2.1 RF Sine Voltage Verification — Interconnections**

*Final Width = 215mm*

*Final Width = 215mm*

## 9.9.2 Verifying the Levelled Sine Function: Flatness (Contd.)

### 9.9.2.4 Verification Setup

- 1. Connections** Ensure that the 9500B is connected to the RF Power Meter as shown in *Fig. 9.9.2.1*, and that both instruments are powered on and warmed up.
- 2. 9500B** Ensure that the 9500B is in MANUAL mode and then select the Sine function ( $\curvearrowright$  key). Select the required output Signal Channel (50 $\Omega$  Load), Trigger Channel and Trigger Ratio (if required).

### 9.9.2.5 Verification Procedure

1. Copy the *Tables 9.9.2.1, 9.9.2.2, 9.9.2.3 and 9.9.2.4*.
2. Starting with *Table 9.9.2.1*, follow the correct sequence of verification points as shown on the table, and carry out operations (3) to (7) at the verification points on the table.
- 3. 9500B**
  - a. Set the **Output Volts p-p** as required for the verification points on the table.
  - b. Set **Frequency** to 50kHz.
  - c. Set Output **ON**.
- 4. Power Meter** Select a power range which gives an on-scale reading (the example **Power Meter** auto-ranges to accommodate the input power).
- 5. 'Ref'**
  - a. Measure the 9500B output power at 50kHz and calculate the Pk-Pk value of 9500B output voltage into 50 $\Omega$ :  
$$\text{Pk-Pk Voltage} = 20\sqrt{(\text{power into } 50\Omega)}$$
  - b. Record the result in the '**Measured p-p Voltage at 50kHz**' column on the *copy of the Table*.
- 6. Flatness**
  - a. Set the 9500B Frequency to the first '**SF**' point in the table.
  - b. measure the 9500B output power and calculate the Pk-Pk value of 9500B output voltage into 50 $\Omega$ :  
$$\text{Pk-Pk Voltage} = 20\sqrt{(\text{power into } 50\Omega)}$$
  - c. Record the result in the '**Measured p-p Voltage for Flatness Check**' column for the verification point on the *copy of the Table*.
  - d. Set the 9500B Frequency to the next '**SF**' point in the table, and repeat operations (b) and (c).
  - e. Repeat operation (d) for all other '**SF**' points in the table available for the UUT variant type.
- 7. 9500B** Set Output **OFF**.

- 8. Other Tables** Repeat Items (2) to (7), but for *Tables 9.9.2.2, 9.9.2.3 and 9.9.2.4* in turn.

The measurements are now complete.

### 9.9.2.6 Calculation of Validity Tolerances

#### 1. Introduction

The first part of the verification procedure in sub-section 9.9.1 deals with verification of amplitude at frequencies below 50kHz, into input impedance of 50 $\Omega$ . A DMM in ACV function is used here as the calibration standard. Unfortunately, the frequency response of DMMs falls off at frequencies which must be used to verify HF flatness above 1MHz, and so a commonly-used technique employs an RF Power Meter. Flatness is normally expressed as a voltage relative to that at a reference frequency of 50kHz, and in our procedure, *Tables 9.9.2.1, 9.9.2.2, 9.9.2.3 and 9.9.2.4* are used to register the values at this reference frequency.

For the flatness verification, each output voltage is measured as power into 50 $\Omega$  in an RF Power Meter, and converting power to pk-to-pk voltage using a formula given in the procedure. This voltage is compared against the power meter reading at 50kHz, by checking that it is within validity tolerance limits about the 50kHz value.

To calculate the validity tolerance limits at each verification point, we must take into account the Total Measurement Uncertainty and the specified 9500B flatness, with respect to 50kHz. These are combined using an RSS calculation..

#### 2. Example: Calculation of Validity Tolerance at 10MHz

- From the Power Meter Specification, let us say that its Total Measurement Uncertainty (Power) at 10MHz, including the Sensor uncertainty, is:  $\pm 1.4\%$ .
- But this is a power uncertainty, and the pk-pk voltage uncertainty will be half:  $\pm 0.7\%$ .
- With this we must combine (by RSS Method) the 9500B pk-pk voltage flatness specification. At 10MHz, the 9500B specification relative to 50kHz is  $\pm 1.5\%$ .

$$\begin{aligned}\text{Validity Tolerance} &= \sqrt{[(0.007)^2 + (.015)^2]} \\ &= \pm 0.01655 = \pm 1.655\%\end{aligned}$$

- We must now multiply this by the **Reference value** at 50kHz, and obtain the higher limit at 10MHz by adding the **Validity Tolerance** to the 50kHz Reference value. The lower limit at 10MHz is found by subtracting the **Validity Tolerance** from the 50kHz Reference value.

### 9.9.2.7 Uncertainty Calculations and Flatness Check

- All Tables**
- Insert the User's Measurement Uncertainty ( $U_m$ ), for each of the verification points in the tables.
  - For each of the verification points: Combine the Total Measurement Uncertainty and the 9500B Sine function accuracy, using the RSS method, to calculate the Flatness Validity Tolerance Limits. For further assistance, refer to *sub-section 9.9.2.6*.
  - Enter the limits in the appropriate columns of the *copy of the Table*.
  - Check that the Measured p-p Voltage is at or between the Flatness Validity Tolerance Limits.

**Table 9.9.2.1 Sine Flatness Verification at 3V p-p into 50Ω Load**

Please copy the following table. Enter the measurements in the **Measured Value** column on the copy:

Verif Point.	Nominal Output Voltage	Output Frequency	Measured p-p Voltage at 50kHz	Specification Relative to 50kHz (% of Output)	User's Total Measurement Uncertainty ( $U_m$ )	Flatness Validity Tolerance Limits		Measured p-p Voltage for Flatness Check
						Lower	Higher	
Ref 1	3V	50kHz						
SF01		1MHz		±2..0				
SF02		50MHz		±2..0				
SF03		100MHz		±2..0				
SF04		250MHz		±2..0				
SF05		400MHz		±2..5				
SF06		550MHz		±2..5				
SF07		600MHz		±3.5				
SF08†		725MHz		±3.5				
SF09†		1GHz		±3.5				
SF10††		1.5GHz		±4.0				
SF11††		2GHz		±4.0				
SF12††	2.5GHz		±4.0					

*Final Width = 215mm*

Additional verification points for: 9500B/1100 & 9500B/3200 (†); and 9500B/3200 (††).

**9.9.2 Verifying the Levelled Sine Function: Flatness** *(Contd.)*

**Table 9.9.2.2 Sine Flatness Verification at 1V p-p into 50Ω Load**

Verif Point.	Nominal Output Voltage	Output Frequency	Measured p-p Voltage at 50kHz	Specification Relative to 50kHz (% of Output)	User's Total Measurement Uncertainty (Um)	Flatness Validity Tolerance Limits		Measured p-p Voltage for Flatness Check
						Lower	Higher	
Ref 2	1V	50kHz						
SF13		10MHz		±2.0				
SF14		50MHz		±2.0				
SF15		100MHz		±2.0				
SF16		250MHz		±2.0				
SF17		400MHz		±2.5				
SF18		550MHz		±2.5				
SF19		600MHz		±3.5				
SF20†			725MHz		±3.5			
SF21†		1GHz		±3.5				
SF22††		1.5GHz		±4.0				
SF23††		2GHz		±4.0				
SF24††		2.5GHz		±4.0				
SF25††		3GHz		±4.0				
SF60†††		4GHz		±4.0				
SF61†††		5GHz		±4.0				
SF62†††		5.5GHz		±4.0				
SF63†††		6GHz		±4.0				

*Final Width = 215mm*

†: Additional verification points for: 9500B/1100 & 9500B/3200 (†); 9500B/3200 only (††) and 9500B/3200 with 9560 (†††).

**Table 9.9.2.3 Sine Flatness Verification at 300mV p-p into 50Ω Load**

Verif Point.	Nominal Output Voltage	Output Frequency	Measured p-p Voltage at 50kHz	Specification Relative to 50kHz (% of Output)	User's Total Measurement Uncertainty (Um)	Flatness Validity Tolerance Limits		Measured p-p Voltage for Flatness Check
						Lower	Higher	
Ref 3	300mV	50kHz						
SF26		10MHz		±2.0				
SF27		50MHz		±2.0				
SF28		100MHz		±2.0				
SF29		250MHz		±2.0				
SF30		400MHz		±2.5				
SF31		550MHz		±2.5				
SF32		600MHz		±2.5				
SF33†		725MHz		±3.5				
SF34†		1GHz		±3.5				
SF35††		1.5GHz		±4.0				
SF36††		2GHz		±4.0				
SF37††		2.5GHz		±4.0				
SF38††		3GHz		±4.0				
SF64†††		4GHz		±4.0				
SF65†††		5GHz		±4.0				
SF66†††		5.5GHz		±4.0				
SF67†††		6GHz		±4.0				

*Final Width = 215mm*

Additional verification points for: 9500B/1100 & 9500B/3200 (†); 9500B/3200 only (††) and 9500B/3200 with 9560 (†††).

*Final Width = 215mm*

**Table 9.9.2.4 Sine Flatness Verification at 100mV p-p into 50Ω Load**

Verif Point.	Nominal Output Voltage	Output Frequency	Measured p-p Voltage at 50kHz	Specification Relative to 50kHz (% of Output)	User's Total Measurement Uncertainty (Um)	Flatness Validity Tolerance Limits		Measured p-p Voltage for Flatness Check	
						Lower	Higher		
Ref 4	100mV	50kHz							
SF39		10MHz		±2.0					
SF40		50MHz		±2.0					
SF41		100MHz		±2.0					
SF42		250MHz		±2.0					
SF43		400MHz		±2.5					
SF44		550MHz		±2.5					
SF45		600MHz		±3.5					
SF46†			725MHz		±3.5				
SF47†			1GHz		±3.5				
SF48††			1.5GHz		±4.0				
SF49††			2GHz		±4.0				
SF50††			2.5GHz		±4.0				
SF51††			3GHz		±4.0				
SF68†††			4GHz		±4.0				
SF69†††	5GHz			±4.0					
SF70†††	5.5GHz			±4.0					
SF71†††	6GHz			±4.0					

Additional verification points for: 9500B/1100 & 9500B/3200 (†); 9500B/3200 only (††) and 9500B/3200 with 9560 (†††).

## 9.9.3 Verifying the Edge Function

### 9.9.3.1 Summary

Equipment requirements are given at *para 9.9.3.2* and test interconnections at *para 9.9.3.3*. *Para 9.9.3.4* shows the Verification Setup.

The Verification Procedure is at *para 9.9.3.5*, A short description of Calculating Validity Tolerances is given at *para 9.9.3.6*, and the final Uncertainty Calculation and Speed Check is at *para 9.9.3.7*.

The Edge Function is verified by carrying out measurements of risetime in the sequences given at *paras 9.9.3.4* and *9.9.3.5*, at the verification points shown in *Table 9.9.3.1*.

### 9.9.3.2 Equipment Requirements

- The UUT Active Head, connected to a verified Model 9500B Mainframe.
- High-bandwidth sampling oscilloscope with bandwidth  $\geq 6\text{GHz}$  for Risetime measurements.  
Examples: *Tektronix Model TDS820 (6/20GHz for 9550/9560)* or *HP54750 (20/50 GHz)*.
- $50\Omega$  SMA - SMA co-axial 'Trigger' cable for trigger inputs to the high-bandwidth oscilloscope.
- High-bandwidth coaxial attenuator may be required if 9500B edge output voltage exceeds oscilloscope input capability.  
Example: *HP8493 Copt20 26.5GHz 3.5mm 20dB attenuator*.
- $50\Omega$  SMA - BNC adaptor :  
Example: *Sumner 33 SMA-BNC-50-1*

### 9.9.3.4 Verification Setup

- 1. Connections** Ensure that the 9500B is connected to the Oscilloscope as shown in *Fig. 9.9.3.1*, and that both instruments are powered on and warmed up.
- 2. Oscilloscope** Select the required function to measure edge response.  
Caution: The 9500B Edge function output is capable of generating voltages that may cause damage to sampling oscilloscope inputs with limited input voltage capability. Use of an attenuator is typically required for outputs above 1V pk-pk.
- 3. 9500B** Ensure that the 9500B is in MANUAL mode and then select the Edge function (⎓ key). Select the required output Signal Channel ( $50\Omega$  Load), Trigger Channel, Cable Select and Trigger Ratio.

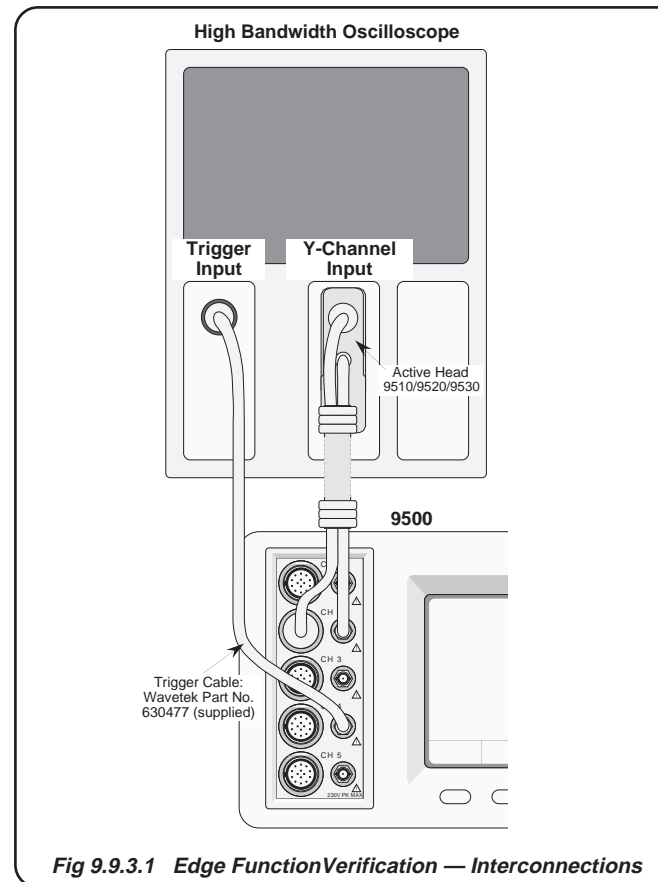

### 9.9.3.3 Interconnections



*Final Width = 215mm*

*Final Width = 215mm*

### 9.9.3.5 Verification Measurement Procedure

1. Copy the *Table 9.9.3.1*.
2. Using *Table 9.9.3.1*, follow the correct sequence of verification points as shown on the table, and carry out operations (3) to (8) at the verification points on the table.
3. **9500B** For the verification point:  
 Select: Edge type:  or   
 Rise time for Model 9510:  $\sqrt{500\text{ps}}$  only  
 for Model 9530:  $\sqrt{500\text{ps}}$  or  $\sqrt{150\text{ps}}$   
 for Model 9560:  $\sqrt{70\text{ps}}$   
 for Model 9550:  $\sqrt{25\text{ps}}$   
 Scope mode or Numeric entry  
 Set: O/P Amplitude p-p  
 O/P Frequency/Period
4. **Oscilloscope**
  - a. Select the correct channel.
  - b. Select the correct sweep speed, trigger level, trigger edge and channel sensitivity to measure at the verification point.
5. **9500B** Set Output **ON**.
6. **Oscilloscope**
  - a. Adjust the sweep speed and trigger level for a stable display.
  - b. Check the waveform for correct polarity ('Rise' selected: from a negative potential to ground; 'Fall' selected: from a positive potential to ground).
7. **Rise Time**
  - a. Measure the (10% to 90%) combined pulse rise/fall time.
  - b. Calculate the Edge function rise/fall time:  
 Edge Function Rise/fall time =  $\sqrt{(\text{Observed Rise Time}^2 - \text{Scope Pulse Response Time}^2)}$  ps
  - c. Record the Measured Edge function rise/fall time on the *copy of the Table*.
  - d. Record the 9500B displayed Rise Time on the *copy of the Table*.
8. **9500B** Set Output **OFF**.

### 9.9.3.6 Calculation of Validity Tolerances

#### 1. Introduction

The first part of the verification procedure in sub-section 9.9.3.5 deals with measurement of rise/fall times, into an input impedance of 50Ω. Each rise/fall time is measured on a wide-bandwidth oscilloscope, whose pulse response time is taken into account.

To calculate the validity tolerance limits at each verification point, we must take into account the User's Total Measurement Uncertainty and the specified 9500B Speed Tolerance. These are combined using an RSS calculation.

#### 2. Example: Calculation of Validity Tolerance (500ps at 25mV)

- From the Oscilloscope Specification, let us say that its Total Measurement Uncertainty (500ps at 25mV), is: **±20ps**.
- With this we must combine (by RSS Method) the 9500B Speed Tolerance specification. At 500ps, the 9500B specification speed tolerance is **+50ps to -150ps**.
- Considering the upper limit:  
**Validity Tolerance** =  $\sqrt{[(20\text{ps})^2 + (50\text{ps})^2]}$   
 = **53.85ps**
- We must now add this **Validity Tolerance** to the Nominal value of 500ps, giving the **Upper Validity Tolerance Limit** of **553.85ps**.
- Considering the lower limit:  
**Validity Tolerance** =  $\sqrt{[(20\text{ps})^2 + (150\text{ps})^2]}$   
 = **151.32ps**
- We must now subtract this **Validity Tolerance** from the Nominal value of 500ps, giving the **Lower Validity Tolerance Limit** of **348.68ps**.

### 9.9.3.7 Calculation of Validity Tolerance Limits and Edge Speed Check

- a. Calculate the User's Total Measurement Uncertainty and Validity Tolerance Limits, and enter in the appropriate columns of the *copy of the Table*. For further assistance, refer to *sub-section 9.9.3.6*
- b. Check that the Measured Value is at or between the Upper and Lower Validity Tolerance Limits.
- c. Check that the difference between the '9500B Displayed Value' [recorded at *para 9.9.3.5 operation 7(d)*] and the 'Measured Value' [recorded at *para 9.9.3.5 operation 7(c)*] is within the 9500B displayed value accuracy specification of the Measured Value (see note † below the table).



**9.9.3 Verifying the Edge Function (Contd.)**

**Table 9.9.3.1 — Edge Function Verification — Rise/Fall Time at 1MHz (Period 1μs) into 50Ω Load**

Please copy the following table. Enter the calculation results and measurements in the appropriate columns on the copy:

Ver. Pt.	Nominal Rise/Fall Time (10% - 90%)	Edge Type	Output Voltage (pk-pk)	Lower Tolerance Limit	Upper Tolerance Limit	User's Total Measurement Uncertainty	Lower Validity Tolerance Limit	Upper Validity Tolerance Limit	Measured Value	9500B Displayed 'Rise Time' Value †
EDG01	500ps	↗	25.000mV	-150ps	+50ps		ps	ps	ps	ps
EDG02		↘								
EDG03	500ps	↗	50.000mV	-150ps	+50ps		ps	ps	ps	ps
EDG04		↘								
EDG05	500ps	↗	250.00mV	-150ps	+50ps		ps	ps	ps	ps
EDG06		↘								
EDG07	500ps	↗	500.00mV	-150ps	+50ps		ps	ps	ps	ps
EDG08		↘								
EDG09	500ps	↗	2.5000V	-150ps	+50ps		ps	ps	ps	ps
EDG10		↘								
EDG11	150ps *	↗	25.000mV	-25ps	+25ps		ps	ps	ps	ps
EDG12		↘								
EDG13	150ps *	↗	50.000mV	-25ps	+25ps		ps	ps	ps	ps
EDG14		↘								
EDG15	150ps *	↗	250.00mV	-25ps	+25ps		ps	ps	ps	ps
EDG16		↘								
EDG17	150ps *	↗	500.00mV	-25ps	+25ps		ps	ps	ps	ps
EDG18		↘								
EDG19	150ps *	↗	2.5000V	-25ps	+25ps		ps	ps	ps	ps
EDG20		↘								











*Final Width = 215mm*

\*: Verification points EDG11 to EDG20 available for Active Head Model 9530 only.

†: 9500B displayed value accuracy specification: for 500ps, ±35ps; for 150ps, ±12ps; for 70ps, ±8ps; for 25ps, ±1.5ps.

**Table 9.9.3.1 — Edge Function Verification Cont**

Please copy the following table. Enter the calculation results and measurements in the appropriate columns on the copy:

Ver. Pt.	Nominal Rise/Fall Time (10% - 90%)	Edge Type	Output Voltage (pk-pk)	Lower Tolerance Limit	Upper Tolerance Limit	User's Total Measurement Uncertainty	Lower Validity Tolerance Limit	Upper Validity Tolerance Limit	Measured Value	9500B Displayed 'Rise Time' Value †
EDG21	70ps **		33.00mV	-12ps	+12ps		ps	ps	ps	ps
EDG22			66.00mV	-12ps	+12ps		ps	ps	ps	ps
EDG23	70ps **		100.00mV	-12ps	+12ps		ps	ps	ps	ps
EDG24			200.00mV	-12ps	+12ps		ps	ps	ps	ps
EDG25	70ps **		330.00mV	-12ps	+12ps		ps	ps	ps	ps
EDG26			660.00mV	-12ps	+12ps		ps	ps	ps	ps
EDG27	70ps **		1.0V	-12ps	+12ps		ps	ps	ps	ps
EDG28			2.0V	-12ps	+12ps		ps	ps	ps	ps
EDG29	25ps ***		500mV	-3ps	+3ps		ps	ps	ps	ps
EDG30			500mV	-3ps	+3ps		ps	ps	ps	ps

*Final Width = 215mm*

\*\* : Verification points EDG21 to EDG28 available for Active Head Model 9560 only.

\*\*\* : Verification points EDG29 to EDG30 available for Active Head Model 9550 only.

## 9.9.4 Verifying the Load Capacitance Measurement Function (—|—)

### 9.9.4.1 Summary

Equipment requirements are given at *para 9.9.4.2* and test interconnections at *para 9.9.4.3*. *Para 9.9.4.4* shows the Verification Setup.

The Verification Procedure is at *para 9.9.4.5*.

The Load Capacitance Measurement Function is verified by carrying out measurements of the capacitance of a calibrated Capacitance Standard in the sequences given at *paras 9.9.4.4* and *9.9.4.5*, at the verification points shown in *Table 9.9.4.1*.

### 9.9.4.2 Equipment Requirements

- The UUT Active Head, connected to a verified Model 9500B Mainframe.
- Two Calibrated Capacitance Units (BNC-terminated):
  - a. Calibrated value between 15pF and 25pF.
  - b. Calibrated value between 85pF and 95pF.

Suitable capacitance values can be constructed from a length of coaxial cable fitted with a BNC connector at one end and open circuit at the other. Measure the capacitance value with a capacitance bridge. If the cable is fitted with a female connector, a BNC male/male adapter is required to interface with the Active Head and must be included in the capacitance value.

### 9.9.4.3 Interconnections

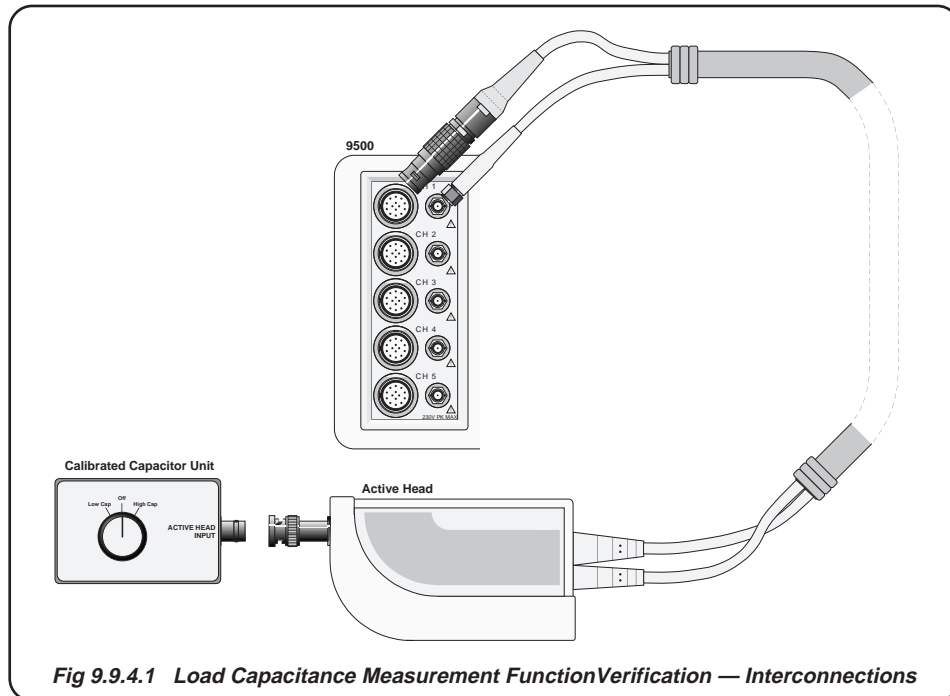

*Final Width = 215mm*

BLANK PAGE (LEFT-HAND)  
Final Width = 215mm

#### 9.9.4.4 Verification Setup

1. Copy the *Table 9.9.4.1*.
2. **Test Capacitor Values**
  - a. Ensure that the two Capacitors have been calibrated.
  - b. Enter the low and high calibrated values in the 'Capacitance Calibrated Value' column of *Table 9.9.4.1*.
3. **Connections** Ensure that the 9500B is connected to the Capacitance unit (or individual capacitors in turn) as shown in *Fig. 9.9.4.1*, and that both instruments are powered on and warmed up.
4. **9500B**
  - a. Ensure that the 9500B is in MANUAL mode. Select the Aux functions (**Aux** key on the right of the front panel). Press the  $\rightarrow$  soft key on the bottom row.
  - b. Select the required output Signal Channel.

#### 9.9.4.5 9500B Absolute Tolerance Calculations

1. Refer to *Table 9.9.4.1*. Ensure that the Test Capacitance Calibrated Values have been entered for the two Test Capacitors (High and Low).
2. Use the specification figures to calculate the 9500B Absolute Tolerance Limits.  
**Example:**  
Let us say that the Test Capacitor value has been calibrated at **20pF**. The specification tolerance for this value is:  $\pm 2\% \pm 0.25\text{pF}$ .  
 $\pm[(2\% \times 20\text{pF}) + 0.25\text{pF}] = \pm[0.4\text{pF} + 0.25\text{pF}] = \mathbf{0.65\text{pF}}$   
We must now subtract this value from 20pF for the lower limit (**19.35pF**), and add it to 20pF for the higher limit (**20.65pF**).
3. Enter the 9500B Absolute Tolerance Limits into their respective columns on *Table 9.9.4.1*.

#### 9.9.4.6 Verification Procedure

Refer to *Table 9.9.4.1*. At each verification point shown on the table, carry out the following operations (1) to (6).

1. **Test Cap** Select the correct **Test Capacitance** for the verification point range.
2. **9500B** Set Output **ON** and wait for the Load Capacitance reading to settle.
3. **Reading**
  - b. Record the 9500B reading in the **Measured Value** column of the *copy of the Table*.
  - c. Check that the **Measured Value** is at or between the **Absolute Tolerance Limits**.
6. **9500B** Set Output **OFF**.

**Table 9.9.4.1 Load Capacitance Measurement Verification**

Please copy the following table. Enter the values in the columns on the copy:

Verif. Point. $\rightarrow$	Capacitance Test Range	Test Capacitance Calibrated Value	9500B Measurement Spec	9500B Absolute Tolerance Limits		9500B Measured Value
				Lower	Higher	
<b>CAP1</b>	Low: 15-25pF	pF	$\pm 2\% \pm 0.25\text{pF}$	pF	pF	pF
<b>CAP2</b>	High: 85-95pF	pF	$\pm 3\% \pm 0.25\text{pF}$	pF	pF	pF

---

# Section 10 Calibrating the Model 9500B

## 10.1 About Section 10

Section 10 outlines general procedures for calibrating the Model 9500B. In it you will find the recommended calibration methods, details of the parameters that require calibration and the procedures needed to calibrate them.

This section is divided into the following sub-sections:

- 10.2 9500B Mainframe Calibration and Active Head™ Calibration  
*Functions and Methods.*
- 10.3 The Model 9500B Calibration Mode  
*Selection of Calibration Mode, Special Calibration and Standard Calibration.*
- 10.4 Standard Calibration — Basic Sequences  
*Using the Target Selection and Adjustment screens*
- 10.5 Front-panel Calibration by Functions  
*General procedure, sequencing, equipment requirements, interconnections, procedures and lists of calibration points for all functions requiring calibration.*
- 10.6 Head Calibration Procedures  
*Calibrating sine, edge, timing markers, load capacitance and 50Ω/1MΩ ratio functions.*

*Final Width = 215mm*

BLANK PAGE (LEFT-HAND)

---

## 10.2 9500B Mainframe Calibration and Active Head™ Calibration

### 10.2.1 Introduction

The Model 9500B has been designed around a 1-year recalibration interval. When they do need recalibration, it is not necessary to lose the entire system while it is being performed.

In addition to being supported by traditional scope calibration standards, the 9500B's mainframe and its Active Heads are calibrated separately. The mainframe unit defines the DC and LF traceability, and is easily calibrated on-site.

All high frequency calibrations (such as the leveled sinewave and pulse outputs) are confined to the Active Heads, which can therefore be calibrated independently. They are small enough and light enough to be sent by regular mail services to a calibration laboratory. Our global network of Service Centers provides a fast turnaround Active Head recalibration service. By substituting a spare head for the one that is being calibrated, the benefits of near-zero downtime become attainable.

### 10.2.2 Mainframe Unit Calibration

Mainframe Unit calibration correction factors are stored in non-volatile calibration memory in the Mainframe Unit. The following calibrations are available:

- **'DC'** voltage, positive and negative outputs, selected using the WAVEFORM soft key on the DC/Square 'Target Selection' screen when in Calibration mode;
- **'Square'** voltage waveforms, positive, negative and symmetrical outputs, selected using the WAVEFORM soft key on the DC/Square 'Target Selection' screen when in Calibration mode;
- **'LF Sine'** function, selected simply by pressing the  front-panel push-button when in Calibration mode;
- **'Resistance Measurement'**, selected by pressing the **Aux** front-panel push-button when in Calibration mode.

### 10.2.3 Active Head Calibration

Active Head calibration correction factors are stored in non-volatile calibration memory in the Active Head itself. The following calibrations are required:

- **'Sine'** flatness above 50kHz;
- **'Low Edge'** and **'Fast Edge'** functions;
- **'Load Capacitance'** measurement functions;
- **'Termination Compensation'** functions.

Head calibration involves the use of a verified 9500B Mainframe.

**Note:** Heads can be calibrated only within the bandwidth of the mainframe.

e.g. Head Model 9510 with Mainframe Variant 9500B/400 can only be calibrated to 400MHz.

### 10.2.4 Other Functions

Other 9500B functions are either derived directly from functions that are calibrated, or are calibrated 'for life' during manufacture:

- Dual-Sine;
- Current;
- Composite Video;
- Linear Ramp;
- Overload Pulse;
- Zero Skew;
- Auxiliary Input;
- Input Leakage.

Attempting to select these functions during Mainframe calibration, (or those in *paras 10.2.3*) while the Model 9500B is in **CAL** mode, will result in an error message being displayed:

No calibration for this function

### 10.2.5 Mainframe Unit Manual Calibration

Mainframe Unit Calibration can be performed manually from the front panel, and this is the main subject of this Section 10:

- **Sub-section 10.3** covers general access to the processes via Calibration Mode;
- **Sub-section 10.4** deals with the general processes of selecting:
  - Hardware configurations (Cal Ranges);
  - Target Values within Cal Ranges;
  - Modifying and saving modified Target Values for individual calibration environments;
  - Adjusting the 9500B output values to calibrate Cal Ranges (thereby storing correction factors in non-volatile Calibration Memory).
- **Sub-section 10.5** details front panel operation to calibrate functions, providing connection diagrams and sequenced procedures.

*Final Width = 215mm*

BLANK PAGE (LEFT-HAND)



---

## 10.3 The Model 9500B Calibration Mode

### 10.3.1 Introduction

This section is a guide to the use of the Model 9500B's Calibration Mode, for manual calibration of the 9500B Mainframe. The following topics are covered:

- 10.3.2 Mode Selection
  - 10.3.2.1 'Mode' Key
  - 10.3.2.2 'Mode Selection' Screen
- 10.3.3 Selection of Calibration Mode
  - 10.3.3.1 Calibration Enable Switch
  - 10.3.3.2 Password
  - 10.3.3.3 Calibration Mode Display
  - 10.3.3.4 Calibration Mode Screen Softkeys
- 10.3.4 Special Calibration
  - 10.3.4.1 Selecting Special Calibration
  - 10.3.4.2 When to Characterise
  - 10.3.4.3 How to Characterise
  - 10.3.4.4 Form of Characterisation
- 10.3.5 Special Cal: 'Adjust FREQ'
  - 10.3.5.1 When to Adjust
  - 10.3.5.2 Equipment Requirements
  - 10.3.5.3 Interconnections
  - 10.3.5.4 9500B and Counter Setup
  - 10.3.5.5 Sequence of Operations
- 10.3.6 Mainframe Standard Calibration (STD CAL)
  - 10.3.6.1 Function Selection
  - 10.3.6.2 Cal Mode Function Screens
  - 10.3.6.3 'Hardware Configurations'
  - 10.3.6.4 'Target Calibration Values'
- 10.3.7 Overview of Calibration Operations

*Final Width = 215mm*

### 10.3.2 Mode Selection

#### 10.3.2.1 'Mode' Key

Selection of any one of the Model 9500B's five operating 'Modes' is enabled by pressing the 'Mode' key at the bottom right of the 'CALIBRATION SYSTEM' key panel.

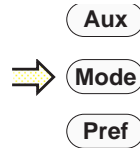

This results in display of the mode selection screen:

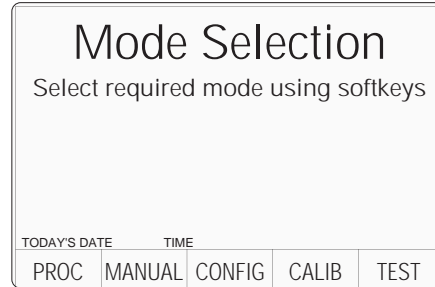

#### 10.3.2.2 'Mode Selection' Screen

The Mode Selection menu screen allows you to select any one of the following operating modes:

<b>PROC</b>	<b>Procedure mode</b>
<b>MANUAL</b>	<b>Manual mode</b>
<b>CONFIG</b>	<b>Configure mode</b>
<b>CALIB</b>	<b>Calibration mode</b>
<b>TEST</b>	<b>Selftest mode</b>

Each mode is selected by pressing the appropriate screen softkey, after which a new menu screen relating specifically to that mode will be displayed. (Note: for the calibration menu screen to appear, certain other conditions must be satisfied — see 10.3.3.)

### 10.3.3 Selection of Calibration Mode

The following two conditions must be satisfied before the Calibration mode menu screen can be accessed:

- The rear-panel Calibration Enable switch must be in the 'ENABLE' position.
- A valid password must have been entered via the front panel keypad.

#### 10.3.3.1 Calibration Enable Switch

The Calibration Enable DIP-switch is accessible, using a small screwdriver, through a recess on the Model 9500B's rear panel.

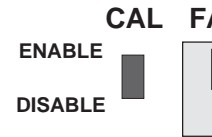

#### DISABLE

With the Calibration Enable switch in the 'DISABLE' position, any attempt to select Calibration mode by pressing the 'CALIB' screen softkey will result in the screen prompt "**Calibration switch not enabled!**" being displayed, and access to Calibration mode will be denied.

#### ENABLE

With the Calibration Enable switch in the 'ENABLE' position, pressing the 'CALIB' screen key will result in the 'Password Entry' user prompt screen being displayed:

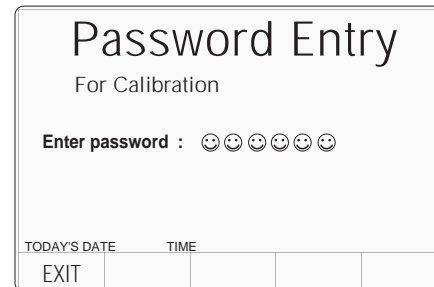

#### 10.3.3.2 Password

Before the Calibration mode menu screen can be displayed you must now enter a valid password using the Model 9500B's alphanumeric keyboard. For information about the initial 'shipment' password, and about the method of changing this to a custom password, refer to *Section 3, paras 3.4.2* of this Handbook.

As each character in the password is entered, security code icons will appear on the screen as shown above. Once the correct password has been entered, pressing the '↵' (Enter) key will result in the Calibration Mode menu screen being displayed. If the wrong password is used, the error message "PASSWORD INCORRECT" will be displayed and the security code character icons will disappear, enabling you to attempt correct password entry again. The 'EXIT' screen softkey will take you back to the Mode Selection screen.

#### 10.3.3.3 Calibration Mode Display

When Calibration mode has been successfully entered by setting the CAL ENABLE switch to the ENABLE position and entering the correct Password, the 'Calibration Mode' menu screen shown below will be displayed:

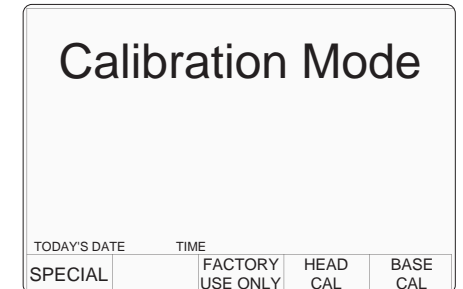

Final Width = 215mm

### 10.3.3.4 Calibration Mode Screen Softkeys

The following screen softkeys are active:

#### SPECIAL

Accesses the Special Calibration menu so that you can perform several 'Chse' (Characterise) calibration operations, which must be done immediately before carrying out routine recalibration of the Model 9500B.

#### FACTORY USE ONLY

Accesses 'factory-set' calibration operations which can only be entered by a special password. These calibration operations only need to be performed when the instrument is manufactured, or after certain types of repair have been carried out on it. The password is not given in this handbook; any user who suspects that such calibration may be needed should contact their Fluke Service Center.

#### STD CAL

Accesses the user control screens for routine external Mainframe calibration of each Model 9500B function able to be calibrated.

## 10.3.4 Special Calibration

### 10.3.4.1 Selecting Special Calibration

Pressing the **SPECIAL** softkey in the **Calibration Mode** screen transfers to the **Special Calibration** screen:

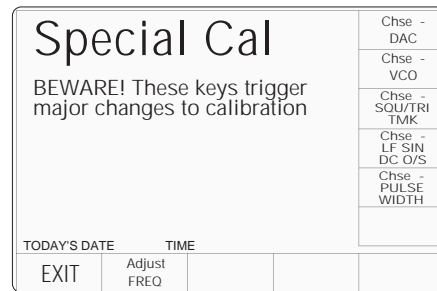

### 10.3.4.2 When to Characterise

Characterisations are adjustments which calibrate basic digital sources of output. These adjustments are only required immediately prior to routine Standard Calibration of the Model 9500B, (detailed in subsequent sub-sections).

**IMPORTANT!** Do not characterise unless you are doing so as part of an authorized recalibration of the Model 9500B. Although the internal adjustment operations which it initiates will not dramatically change the overall calibration of the instrument, they will introduce a very small 'artificial' step into its apparent drift performance. If your company maintains historical records on each calibrator's drift performance between calibrations (for example, for the purposes of statistical process control in a total quality management system), this artificial step would need to be determined and suitably recorded in these records. There are no performance advantages to be gained by characterising at any time other than immediately before Standard Calibration of the Model 9500B's functions.

### 10.3.4.3 How to Characterise

Characterisation is performed merely by pressing the appropriate 'Chse - ...' soft key. When characterising, do so in the following sequence:

1. Chse - DAC.
2. Chse - VCO.
3. Chse - SQU/TRI TMK.
4. Chse - LF SIN DC O/S.
5. Chse - PULSE WIDTH.

**Note:** Selected characterisation has completed when single highlighted softkey selected is replaced by complete softkey menu display.

### 10.3.4.4 Form of Characterisation

The Characterise operations comprise sets of fully automatic internal adjustments, such as (in the case of Chse - DAC) checking and calibrating the linearity of the 9500B D-A converter, which is used to set the amplitude of its analog output functions.

Press **EXIT** to return to the calibration mode menu screen on completion of all characterisations.

*Final Width = 215mm*

### 10.3.5 Special Cal: 'Adjust FREQ'

This is really a calibration of the internal frequency source, to an external frequency standard. The 9500B generates a stream of square wave timing markers (as in Time Markers function — refer to *Section 4.8*) at 100MHz. This is applied to the external frequency standard, and the internal frequency DAC factor is adjusted until the external counter registers 100MHz.

#### 10.3.5.1 When to Adjust

The 9500B Frequency Uncertainty (5 years) is specified at 100MHz as:  $\pm 0.25\text{ppm}$ .

In either case, it is normally unnecessary to adjust the frequency at less than 5 year intervals.

#### 10.3.5.2 Equipment Requirements

- Digital counter for 0.25ppm clock accuracy measurements.  
Example: Hewlett Packard Model HP53131A with Option 012.

Final Width = 215mm

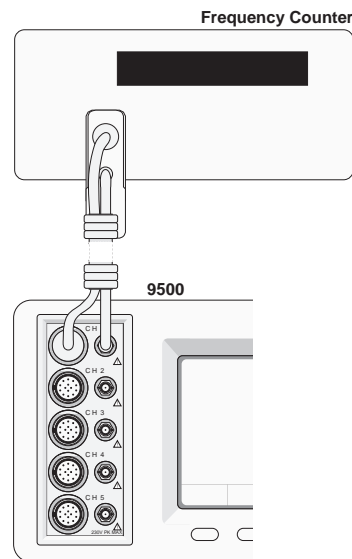

#### 10.3.5.3 Interconnections

##### 10.3.5.4 9500B and Counter Setup

- 1. Connections** Connect the 9500B to the Counter as shown in *Para 10.3.5.3*, and ensure that both instruments are powered ON and warmed up. Any model number head may be used (except 9550).
- 2. Counter** Select the required function to measure frequency.
- 3. 9500B** In the **Calibration Mode** screen, press the **SPECIAL** soft key on the left of the bottom row. This transfers to the **Special Cal** screen shown in *Para 10.3.4.1*.

#### 10.3.5.5 Sequence of Operations

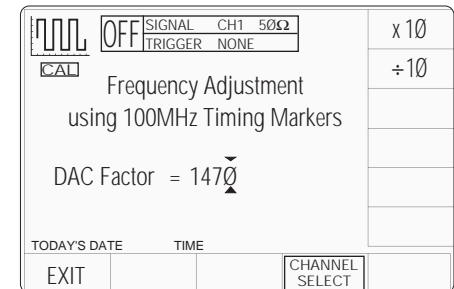

- 1. 9500B** In the **Special Cal** screen, press the **Adjust FREQ** soft key on the bottom row. This transfers to the **Frequency Adjustment** screen:
- 2. Counter** Select the correct display time, trigger source and level to measure at the calibration point.
- 3. 9500B** Set Output **ON**.
- 4. Counter** Adjust the trigger level for a stable display and note the measured frequency.
- 5. 9500B**
  - a. Use the cursor keys to increment or decrement the DAC Factor value until the Counter registers a frequency of 100MHz.
  - b. Set Output **OFF**.
  - c. Press the **EXIT** soft key on the bottom row to return to the **Special Cal** screen.

Frequency calibration is now complete.

### 10.3.6 Mainframe Standard Calibration (BASE CAL)

#### 10.3.6.1 Function Selection

Pressing the 'BASE CAL' screen softkey displays a DC/Square/DC CAL function screen (the 'Target Selection' screen) shown below, which appears on entry to Standard Calibration.

Other available Mainframe calibrations are:

- **DC/Square Function: 'DC Negative' and 'Square' waveforms**, selected using the WAVEFORM soft key:

- **Sine Function**, selected simply by pressing the  front-panel push-button.

- **Resistance Measurement**, selected by pressing the **Aux** front-panel push-button.

Note that the other 9500B functions, listed in *paras 10.2.3 and 10.2.4* cannot be externally adjusted during Mainframe calibration (they are either derived directly from functions that can be calibrated, or are calibrated 'for life' during manufacture, or are adjusted during 'Head' calibration). Attempting to select these functions during Mainframe calibration, while the Model 9500B is in CAL mode, will result in an error message being displayed:

No calibration for this function

#### 10.3.6.2 Cal Mode Function Screens

Generally, two special screens are provided to adjust each of the functions' calibration points. In CAL mode, the purpose of these screens is to allow you to set the 9500B into the various hardware configurations (also known as 'Cal Ranges') required during calibration, and initiate the necessary sequences of operations.

Each Function/Waveform is identified by the usual symbol in the top left corner.

#### 10.3.6.3 'Hardware Configurations'

Although all functions in the 9500B appear to the operator to have a single continuous range which covers the entire span of output values from the lowest to the highest (e.g., for DC Voltage from 888.00μV to 222.4V), internal devices such as voltage dividers and power amplifiers must be switched to achieve this total span. With this switching, the hardware configuration changes.

Because each of these configurations introduces slight offset and gain errors into the 9500B output, they must be compensated by calibration in order to maintain the 9500B's very high level of performance. Calibration of the 9500B determines and stores the offset and gain errors associated with each hardware configuration, so that they can be digitally compensated by the instrument's control processor. The processor applies digital correction factors to the selected output value, so that the analog output accurately matches the selected value (within its specification). This results in an accurate and linear output response across each function's entire output span.

#### 10.3.6.4 'Target Calibration Values'

Individual hardware configurations are calibrated by accurately measuring their analog outputs at (usually) two or more points using a higher order calibration standard. In most cases these 'target calibration values' are values close to the lower and upper extremes of the

Final Width = 215mm

hardware configuration's output capability.

### 10.3.7 Overview of Calibration Operations

In general, calibration of each of the 9500B's hardware configurations can be broken down into three distinct stages as follows:

- 1) Selection of the required hardware configuration (Target Selection screen).
- 2) Selection of 'target' values at which this hardware configuration will be calibrated (Target Selection screen).
- 3) Modification of the target values and determination of the 9500B's output error at each of these values (Adjustment screen).

The **Target Selection** screen is used to select the correct hardware configuration, expressed as 'Cal Range', and permits you to opt to use Fluke's recommended 'default' target calibration values or custom target values (close to the default values) more appropriate to the equipment being used for calibration purposes.

Selecting one of the target values displayed in the target selection screen (by pressing its corresponding **Target** softkey) transfers you to the **Adjustment** screen, where you can optionally alter and save the target value before measuring the output error and generating a compensating correction.

These three stages are described in more detail in *Section 10.4*, while descriptions of the calibration sequences for each individual function are provided in *Section 10.5*.

The flow chart shown on the right summarizes the operator actions needed to enter Calibration mode, and to then select an appropriate function for calibration.

Final Width = 215mm

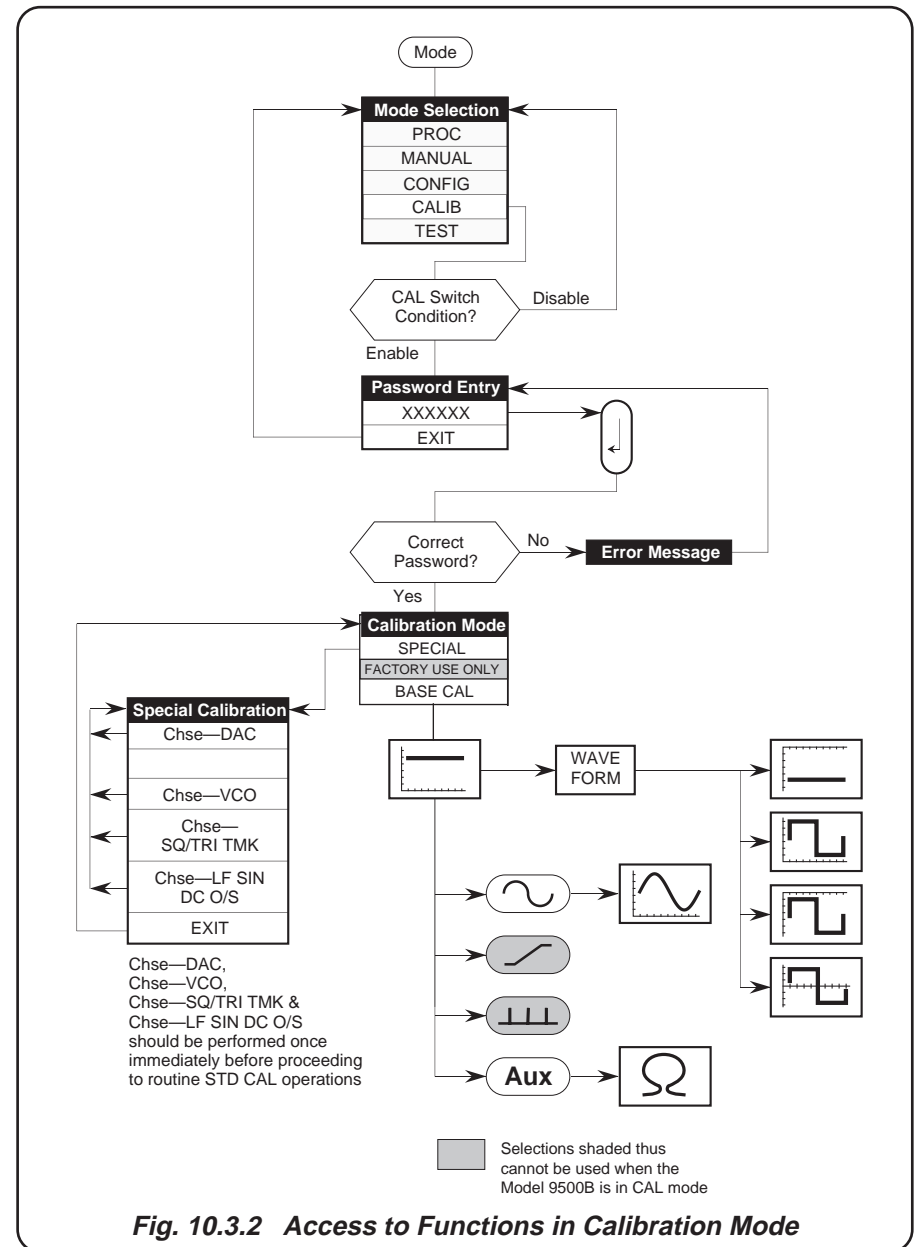

Fig. 10.3.2 Access to Functions in Calibration Mode

---

## 10.4 Standard Calibration — Basic Sequences

This sub-section describes in more detail the main processes involved when calibrating each of the Model 9500B's 'hardware configurations' from the instrument's front panel.

The following topics are covered:

- 10.4.1 Introduction
  - 10.4.1.1 Aim of Calibration
  - 10.4.1.2 General Calibration Process
- 10.4.2 Target Selection Screen — Selecting Hardware Configurations
  - 10.4.2.1 Waveform Selection
  - 10.4.2.2 Hardware Configurations
  - 10.4.2.3 Channel Selections
  - 10.4.2.4 Retained Channel Memory
  - 10.4.2.5 'Default' or 'Saved' Targets
- 10.4.3 The Adjustment Screen
  - 10.4.3.1 Setting Target Values
  - 10.4.3.2 Selecting Default Calibration Targets
  - 10.4.3.3 Modifying a Calibration Target
- 10.4.4 Calibrating the Model 9500B at Target Values
  - 10.4.4.1 Adjust Output Amplitude
  - 10.4.4.2 Target Selection
  - 10.4.4.3 'RESET CAL POINT'
- 10.4.5 Standard Calibration of AC Functions
  - 10.4.5.1 Output Frequency Synthesis
  - 10.4.5.2 Changing the Output Frequency of Target Calibration Points
- 10.4.6 Exit from Calibration - Cal Date and Cal Due Date
  - 10.4.6.1 Exit: Mode Key — Warning Screen
  - 10.4.6.2 Exit Only
  - 10.4.6.3 Update the Date Stamp on a Certificate
  - 10.4.6.4 Setting the Cal Due Date and Advance Warning Period

*Final Width = 215mm*

## 10.4.1 Introduction

### 10.4.1.1 Aim of Calibration

The aim of calibrating the Model 9500B Oscilloscope calibrator is to determine the accuracy of its outputs, and if necessary adjust them so that they are within specification. If this calibration is to be traceable, then the 9500B's outputs must be compared with Traceable calibration standards of suitable 'Test Uncertainty Ratio'.

### 10.4.1.2 General Calibration Process

As mentioned earlier in *Section 10.3*, calibrating each of the 9500B's functions can be broken down into three distinct stages as follows:

- 1) Select the required 'hardware configuration' by selecting the correct 'Cal Range'.
- 2) Select 'target' values at which this hardware configuration will be calibrated.
- 3) Determine the 9500B's output error at each of these target values, and generate a suitable compensating correction factor.

This sub-section *10.4* describes the *general* process of calibrating the 9500B using front-panel controls.

The following description uses, as an example, the DC/Square function, which has eleven positive-DC hardware configurations (called 'Cal Ranges') to generate output voltages between +888.00mV and +222.40V. Each Cal Range requires two target-value calibration points, generating two associated correction factors. The factors are stored in non-volatile memory, and are subsequently used to correct all outputs which employ the hardware configuration.

We will start by assuming that the 'Cal' mode of the DC Voltage function has been selected as described in *Section 10.3* of this handbook. This presents the 'Target Selection' screen, similar to that illustrated in the next column.

## 10.4.2 Target Selection Screen — Selecting Hardware Configurations

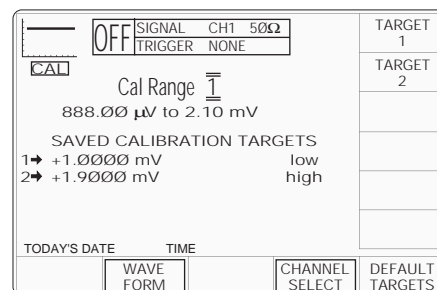

### 10.4.2.1 Waveform Selection

Refer to *para 10.3.6.1*.

### 10.4.2.2 Hardware Configurations

For a given function, selecting a particular 'Cal Range' switches in the relevant hardware configuration which will generate the required span from the function's total output range. The span of the hardware configuration appears under the 'Cal Range' selection on the screen.

For example, the total output range in DC/Square function (DC positive output) consists of eleven separate hardware configurations numbered as Cal Ranges:

- |     |          |    |          |
|-----|----------|----|----------|
| 1:  | 888.00mV | to | 2.10mV   |
| 2:  | 2.10mV   | to | 5.56mV   |
| 3:  | 5.56mV   | to | 21.00mV  |
| 4:  | 21.00mV  | to | 55.60mV  |
| 5:  | 55.60mV  | to | 210.00mV |
| 6:  | 210.00mV | to | 556.00mV |
| 7:  | 556.00mV | to | 21.0V    |
| 8:  | 21.0V    | to | 5.56V    |
| 9:  | 5.56V    | to | 22.24V   |
| 10: | 22.24V   | to | 55.60V   |
| 11: | 55.60V   | to | 222.40V  |

Hence hardware configuration (1) can be selected by setting the Cal Range to '1'. Hardware configuration (2) can be selected by setting the Cal Range to '2' etc., using the  $\uparrow$  and  $\downarrow$  cursor keys or spinwheel.

The full list of Cal Ranges used to establish all the required hardware configurations for each function are given in the detailed calibration procedures contained in *Section 10.5* of this handbook.

Note that in this instance, by selecting Cal Range 1, two 'Saved Calibration targets' appear: 1. → +1.0000mV (Low), and 2. → +1.9000mV (High).

### 10.4.2.3 Channel Selections

Connection of the Mainframe to the standards equipment must be routed through a signal channel head, with a trigger channel/cable if necessary. Signal Channel selection, Trigger Channel selection, Cable selection and Trigger Ratio operate in the same way as in normal DC/Square function. Refer to *paras 4.5.3*.

### 10.4.2.4 Retained Channel Memory

Refer to *para 4.5.3.6*.

### 10.4.2.5 'Default' or 'Saved' Targets

For each function and Cal Range, users can choose 'Default' or 'Saved' calibration targets. Pre-programmed **Default Targets**, selected by pressing the 'DEFAULTTARGETS' softkey (which becomes highlighted), are those considered by Fluke to be generally appropriate for use unless a user decides otherwise (shown in the list for DC Positive in *para 10.4.2.2*).

**Saved Targets** are those previously set and saved in earlier calibrations, available when the 'DEFAULT TARGETS' softkey is not highlighted. The former user has deemed that, for the calibration environment being employed at the time, the saved value of a target is more appropriate than the default target. The 'save' action is described later in *paras 10.4.3*.

Final Width = 215mm



### 10.4.3 The Adjustment Screen

Using this screen, action is taken to perform the adjustment at or close to the selected calibration target, having already selected the hardware configuration and committed to 'default' or 'saved' targets, on the Target Selection screen (refer to *paras 10.4.2*).

#### 10.4.3.1 Setting Target Values

Once the correct hardware configuration has been chosen on the Target Selection screen by selecting the Cal Range; pressing one of the **TARGET** softkeys will Transfer to the 'Adjustment' screen — similar to the following:

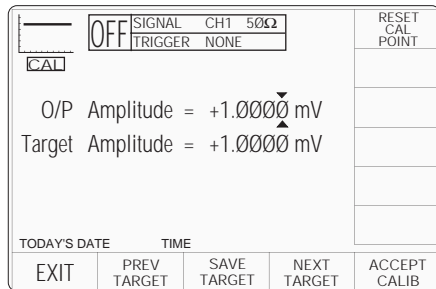

This screen initially shows the value to which the 9500B output is presently set, and the value of the selected target amplitude (whether 'default' or 'saved'). Note that on these values, triangular cursors indicate which digit will change when using the cursor keys or spinwheel. When transferring, using the 'tab' key, the cursor always moves to the least significant digit on the other value.

Output and Target Amplitude control on this screen is similar to normal operation of the 9500B, either by digit edit method (cursor controls/spinwheel operating on one digit at a time), or direct edit method (numeric keypad).

At this point you have already chosen to use either the default or saved value which is now shown on the screen.

At any time you can return to the **Target Selection** screen by pressing the **EXIT** softkey.

#### 10.4.3.2 Selecting Default Calibration Targets

As mentioned earlier, the Model 9500B's firmware contains a complete set of recommended target calibration values, for every hardware configuration of every function that can be directly calibrated.

Before changing from 'Saved' calibration target values back to 'Default' target values, consider that there may have been good reasons for choosing values other than default values at the previous calibration. Your calibration standards may be uniquely characterized at particular target values (for example, standard cells may provide a calibration point voltage different from the default value). Using default target values may therefore reduce the usefulness of historical calibration records.

- If you decide to use default values, rather than the values at which your 9500B was previously calibrated (assuming that the 'saved' and 'default' values are different), simply press the **DEFAULT TARGETS** softkey on the **Target Selection** screen.
- The targets on the screen will have a new title: **DEFAULT CALIBRATION TARGETS**, and the **DEFAULT TARGETS** soft key will be highlighted.
- When passing to the **Adjustment** screen by selecting a target, the default target value will be shown, and from this point, all targets will be default targets until you change back to saved targets again, or decide to change the selected target value.
- Back on the **Target Selection** screen, pressing the **DEFAULT TARGETS** soft key again will restore the title **SAVED CALIBRATION TARGETS**, and the target values will revert to the saved values — i.e. the **DEFAULT TARGETS** key toggles between the 'Saved' and 'Default' sets of target values.

#### 10.4.3.3 Modifying a Calibration Target

Once the **Adjustment** screen is displayed, the existing target value can be changed to a new value, if this is preferable to using either the default target value or a target value 'saved' from a previous calibration. The target value can be changed whether it starts as a default or a saved target, but will always become a new *saved* target. The default target values will not change.

To change the existing Target Amplitude:

- Use the 'tab' key to place the cursor on its value, then use the  $\uparrow$ ,  $\downarrow$ ,  $\leftarrow$  and  $\rightarrow$  keys to set the required target amplitude.

**Note:** The extent to which the target value can be changed from the default value is limited. In our example at 1.0000mV, the target cannot be set above 1.0700mV, nor below 0.9300mV. Beyond these limits the error message 'Outside amplitude range' is given.

- Press the **SAVE TARGET** soft key to record the change. A message will appear 'TARGET SAVED'.
- You can check that the change has been recorded by pressing **EXIT** to return to the **Target Selection** screen, where the different value will have appeared against that *saved* target (unless the **DEFAULT TARGETS** key is highlighted). If default targets remain selected, then they will not have changed, merely press the **DEFAULT TARGETS** key to return to saved targets to note the change in saved target value.
- Returning to the **Adjustment** screen by pressing the same target soft key, it can be seen that the 9500B O/P Amplitude has also changed to the saved value in preparation for adjustment.

*Final Width = 215mm*

## 10.4.4 Calibrating the Model 9500B at Target Values

### 10.4.4.1 Adjust Output Amplitude

Once the target value is as required, the next step is to set up the external circuit so that the output can be measured by a suitable external Standard.

To calibrate at the target value, use the **Adjustment** screen:

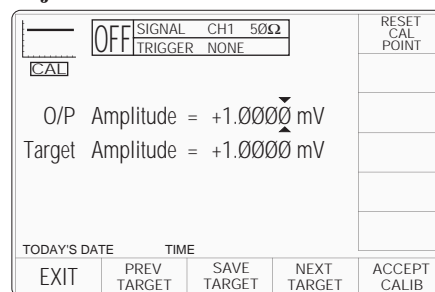

- Ensure that the **Output is OFF**.

**IMPORTANT!** Do not press the **ACCEPT CALIB** softkey while using the **Adjustment** screen unless you are sure that you wish to perform an authorized recalibration of the selected hardware configuration at the selected target value. To prevent accidental calibrations due to inadvertent use of the **CALIB** key, initial use of the **Adjustment** screen takes place with the 9500B output **OFF**. If you accidentally press the **ACCEPT CALIB** key, or attempt a calibration without first turning the 9500B output on, the following error message will be shown:

#### Output must be ON for CAL

Under output-off conditions, the existing, stored calibration corrections will remain unchanged.

- Ensure that the **Adjustment** screen is displayed, with the cursor on the **O/P Amplitude** value.

- Set the Output ON. The displayed output value has already followed to match the target value, so the external Standard measurement will include the error between the output value and the target value.
- With the cursor on the **O/P Amplitude** value, use the  $\uparrow$ ,  $\downarrow$ ,  $\leftarrow$  and  $\rightarrow$  keys to adjust the output amplitude until the external Standard measurement is the same as the target value.  
Note that the O/P Amplitude display will now include the error.

**Note:** Limits are placed on the extent to which the Output Amplitude value can be changed. In our example at 1.0000mV, the amplitude cannot be set above 1.4500mV, nor below 0.8880mV. Beyond these limits the error message 'Outside amplitude range' is given.

- Once you are satisfied that the external measurement matches the Target value, perform the adjustment by pressing the **ACCEPT CALIB** soft key. The displayed O/P Amplitude value returns to the Target value, the external Standard measurement remains the same as the Target value and the adjustment at this target is complete.

### 10.4.4.2 Target Selection

On the **Adjustment** screen, using the **NEXT TARGET** and **PREV TARGET** soft keys, it is possible to move backwards and forwards along the current target list for the selected function *without* returning to the **Target Selection** screen.. The lists are in *Sub-section 10.5*.

For example: if the present Cal Range in DC/Square function DC Positive target is Cal Range 2, and the Target 1 (low — +2.3000mV) is selected, then pressing the **NEXT TARGET** soft key transfers to Cal Range 2, Target 2 (high — +5.0000mV).

On the other hand: from the same target, then pressing the **PREV TARGET** soft key transfers to Cal Range 1, Target 2 (high — +1.9000mV).

### 10.4.4.3 'RESET CAL POINT'

Over a series of recalibration periods, a condition may be reached when the Calibration memory for a particular Cal Point is heavily biased in one direction. A conflict can arise between the limits on the O/P Amplitude value and the target value. In response to successive attempts at adjustment, the 9500B will keep repeating the error message 'Outside amplitude range' and calibration is not accepted.

This conflict can often be resolved by pressing the 'RESET CAL POINT' soft key to clear the cal memory to zero, then recalibrating.

If this does not work, then it could indicate one of two causes:

1. the Model 9500B has developed a fault.
2. the measuring instrument has developed a fault, is incorrectly set up, or is incorrectly connected to the Model 9500B's terminals.

The cause should be determined and rectified before proceeding. If this is not possible, then you should contact your Fluke Service Center.

Final Width = 215mm

## 10.4.5 Standard Calibration of AC Functions

Standard calibration of the Square Voltage and Sine Voltage functions in the 9500B uses the same procedure as that described in *Paras 10.4.1 to 10.4.4* of this section except that the *frequency* of the target calibration points must also be set.

### 10.4.5.1 Output Frequency Synthesis

The frequency of the Model 9500B's Square Voltage and Sine Voltage output is derived digitally from an internal reference frequency crystal, which is sufficiently stable for the output frequencies of these functions not to require any routine calibration for at least 5 years (*Refer to paras 10.3.5*).

### 10.4.5.2 Changing the Output Frequency of Target Calibration Points.

When you display target selection screens for AC functions on the **Target Selection** screen, you will notice that the Saved Calibration Targets and Default Calibration Targets all include a target calibration point frequency. As an example, the default calibration targets for the Symmetrical Square Voltage, Cal Range 1 — Target 2 are illustrated in the following screen:

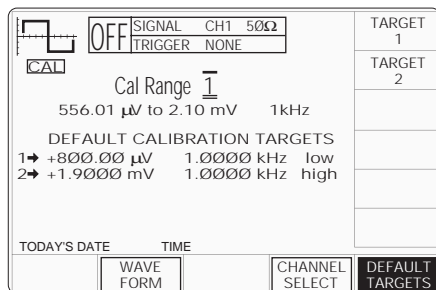

When you select target 2 by pressing its soft key, the Target Amplitude and Frequency will be displayed below the current Output Amplitude as shown in the following **Adjustment** screen illustration:

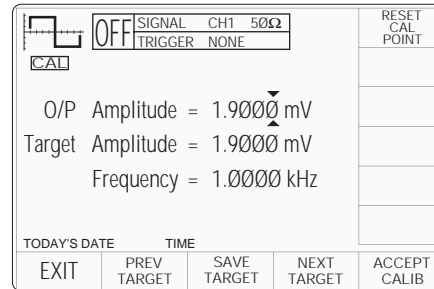

If you now wish to change the calibration point frequency, this must be done by editing the Frequency setting.

- To do this, first transfer cursor control to the Frequency setting via the Tab (→) key. Then alter the frequency setting using the same digit edit (cursor controls/spinwheel) method or direct edit (numeric keypad) method used to change Output and Target Amplitude.

**Note:** Limits are placed on the extent to which the Frequency value can be changed. In our example at 1.0000kHz, the frequency cannot be set above 1.0500kHz, nor below 0.9500kHz. Beyond these limits the error message 'Outside frequency range' is given.

Once the target has been saved, the new saved Frequency will be shown as well as any new saved Target Amplitude on the **Target Selection** screen, when the 'DEFAULT TARGETS' soft key label is not highlighted. Calibration can now continue as detailed in *Paras 10.4.4*.

Final Width = 215mm

### 10.4.6 Exit from Base Calibration - Cal Date and Cal Due Date

Once all calibration has been completed, you will wish to return to normal operation, which requires a short 'exit' process. The normal means of exit from Calibration mode is to press the **Mode** key on the right of the front panel. When you do this, the 9500B will present a **Warning** screen to indicate that the 9500B calibration may have changed, and to offer you the following options:

- altering the date-stamp on any directly-printed results certificate (or not),
- entering or altering the calibration due date,
- indicate the advance warning period required before the cal due date.

The following paragraphs show the screens, required actions and consequences.

#### 10.4.6.1 Exit: Mode Key — Warning Screen

To exit from Calibration, press the **Mode** key on the right of the front panel. The 9500B will present a 'Warning' display on the screen:

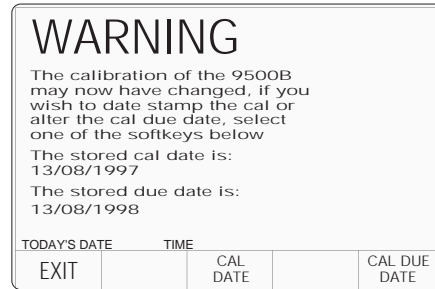

#### 10.4.6.2 Exit Only

If you do not wish to alter the date-stamp, and do not wish to alter the cal due date or its advance warning period, press the **EXIT** key. This terminates the calibration session, and you will be returned to the **Mode Selection** screen to select another mode.

#### 10.4.6.3 Update the Date Stamp on a Certificate

If you wish to update the date stamp to today's date, press the **CAL DATE** key. The 9500B presents the Cal Date screen:



The alpha-numeric keypad is locked out.

If updating the date-stamp is all that is required, without altering the due date, press the **EXIT** screen key to return to the **Mode Selection** screen.

#### 10.4.6.4 Setting the Cal Due Date and Advance Warning Period

**N.B.** If these parameters are not altered, then those which are already stored will be presented on any directly-printed certificate.

To alter the CAL DUE date, press the **CAL DUE DATE** key. The 9500B will present the CAL DUE DATE screen:

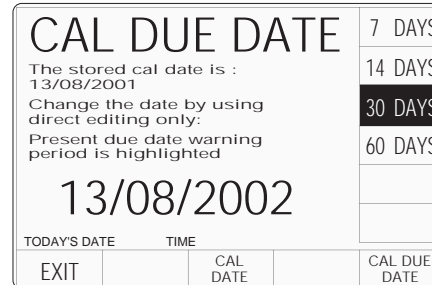

This screen also displays a stored CAL DATE reminder for calculating the cal due date.

If you do not wish to update the **CAL DUE DATE**, press the **EXIT** screen key.

#### Setting the Cal Due Date

To set a new **CAL DUE DATE**, use the alpha-numeric keypad to type in the required due date, then press the Enter (↵) key. Note that the screen presentation uses the 'DATE TIME' format set in Configuration mode, and should be observed, otherwise the advance warning period could be calculated from an incorrect date!—refer to *User's Handbook (Operation)*, Section 3, paras 3.4.3.12.

#### Advance Warning Period

In order to inform a user that the future due date for calibration is approaching, the 9500B will place a warning on the screen, starting at the nominated period of time before the due date, every time the 9500B is powered on:



After the Cal due date, the message changes to:

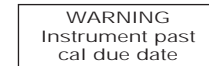

#### Setting the Advance Warning Period

On the CAL DUE DATE screen, the present setting of the advance warning period is shown highlighted against one of the right screen keys. This period is altered by pressing the appropriate right screen key.

#### Final Exit from Calibration Mode

When satisfied that the **CAL DUE DATE** and advance warning period are correct, press the **EXIT** screen key to terminate calibration and return to the **Mode Selection** screen.

The stored Cal Date and Cal Due Date will appear on any directly-printed certificate for this calibration.

Final Width = 215mm

---

## 10.5 Front Panel Base Calibration by Functions

### 10.5.1 Introduction

Sub-section 10.5 is a guide to the process of calibrating the Model 9500B's functions from the front panel. The following topics are covered:

- 10.5.2 Summary of Calibration Process
  - 10.5.2.1 General Procedure
  - 10.5.2.2 Sequencing Calibrations
- 10.5.3 DC/Square (DC Voltage) Calibration
- 10.5.4 DC/Square (Square Voltage) Calibration
- 10.5.5 LF Sine Calibration
- 10.5.6 Load Resistance Measurement Calibration

### Other Functions

No calibration is required for the following functions, as they are either calibrated for life at manufacture, or calibrated automatically as a result of calibrating the functions listed above, as shown in the table:

Function	Calibration Performed
HF Sine flatness above 50kHz	Head Calibration
500ps, High and Fast Edge	Head Calibration
Load Capacitance	Head Calibration
Termination Compensation	Head Calibration
Dual Sine	Via Sine (LF & Flatness)
Frequency	Special Calibration
Current	Via DC/Square
Linear Ramp	N/A
Overload Pulse	N/A
Zero Skew	N/A
Auxiliary Input	N/A
Input Leakage	N/A
Pulse Width	N/A

*Final Width = 215mm*

There are therefore no manual calibration procedures for functions listed in the table, although confidence checks for them can be performed (e.g. the Full Selftest procedure detailed in *9500B User's Handbook (Operation and Performance) Section 8, sub-section 8.3*).

---

## 10.5.2 Summary of Calibration Process

### 10.5.2.1 General Procedure

Subsections 10.3 and 10.4 introduced the general calibration process for the Model 9500B. They also outlined the methods used to select functions, hardware configurations and target calibration points, and how to calibrate the 9500B at these target points.

This entire process is outlined again here as a sequence of simple steps:-

1. Ensure that the 9500B output is **OFF**.
2. Connect the necessary measuring equipment to the 9500B's output terminals, and set it to the required measurement function and range.
3. Ensure that the rear-panel **CAL** (Calibration) switch is set to the **ENABLE** position.
4. Press the front panel **Mode** key to display the **Mode Selection** screen.
5. Press the **CALIB** screen key to display the **Password Entry for Calibration** screen.
6. Enter the correct password and press the  $\leftarrow$  key to display the **Calibration Mode** screen.
7. Press the **Special** screen key to display the **Special Calibration** screen.

**IMPORTANT NOTE:** The Characterise operations 8-12 below should be performed once only, immediately before performing Standard Calibration of the 9500B. It is **not** necessary to repeat them before calibrating each individual function of the 9500B.

8. Press the **Chse-DAC** screen key to initiate the Characterise DAC operations and wait until these automatic internal adjustments have been successfully completed.
9. Press the **Chse-VCO** screen key to initiate the Characterise VCO operations and wait until these automatic internal adjustments have been successfully completed.
10. Press the **Chse-SQU/TRI TMK** screen key to initiate the Characterise Timing Marker operations and wait until these automatic internal adjustments have been successfully completed.
11. Press the **Chse-LF SINDC O/S** screen key to initiate the Characterise LF Sine DC Offset operations and wait until these automatic internal adjustments have been successfully completed.

12. Press the **Chse-PULSE WIDTH** screen key to initiate the Characterise Pulse Width operations and wait until these automatic internal adjustments have been successfully completed.

13. Press the **EXIT** soft key to display the **Calibration Mode** screen.

14. Press the **BASE CAL** screen key to see the Standard Calibration initial default screen — the **DC/Square; DC+ Voltage** function; **Target Selection** screen.

15. Select the function to be calibrated.

Standard Calibration can only be carried out for the following functions:

DC/Square (Select waveforms via the **WAVEFORM** soft key);

Sine (Select by pressing the front panel  $\sim$  key);

Resistance Measurement (Select by pressing the front panel **Aux** key).

**Note:** Because in calibrating Resistance Measurement, the 9500B does not produce an output, it does not conform exactly to the following sequence. Instead, refer to *sub-section 10.5.6*.

16. Select the required output signal channel, trigger channel and Trigger Ratio (if required) via the **Target Selection** screen. Any channel may be used for mainframe calibration.

17. Select the required 9500B hardware configuration by choosing the appropriate **Cal Range**. (Details of each function's hardware configurations and suitable output values to select them can be found in the detailed procedures provided later in this section.)

18. a) If you wish to use the 'saved' target calibration points used during the previous calibration of the 9500B, do *not* press the **DEFAULT TARGETS** screen key.

b) If you wish to use the default target calibration points defined for this hardware configuration, *press* the **DEFAULT TARGETS** screen key.

19. Press the **TARGET 1** or **TARGET 2** screen key to display the target's **Adjustment** screen.

20. a) If you wish to change the amplitude of the target calibration point, press the **TAB**  $\rightarrow$  key one or more times until the cursor is positioned on the target amplitude value. Now use any editing mode to change this value (note that the new value must lie within the limits specified in the detailed procedures provided later in this section).

b) (For Square or Sine functions only) If you wish to change the frequency of the target calibration point, press the **TAB**  $\rightarrow$  key

*Final Width = 215mm*

one or more times until the cursor is positioned on the Frequency value. Now use any editing mode to change this value (note that the new value must lie within the limits specified in the detailed procedures provided later in this section).

c) Press the **SAVE TARGET** soft key.

21. Press the 9500B's **ON** key to turn its output on.
22. Ensure that cursor control is returned to the 9500B output amplitude display, and increment or decrement this value using the cursor controls and/or spinwheel until the reading on the measuring instrument (connected to the 9500B's front-panel active head channel) is the same as the displayed target value. (Note: make sure to allow for any settling time required by the external measuring instrument.)
23. When you are satisfied with the measurement, press the **ACCEPT CALIB** key to generate and implement the correction factor required by the 9500B, to ensure that its displayed output value and actual output value coincide.

**Note:** In Operations (23) to (25), the 'NEXT TARGET' and 'PREV TARGET' keys provide a shortcut to avoid returning to the **Target Selection** screen.

24. Press EXIT to return to the **Target Selection** screen.
25. Repeat steps (17) to (23) for each of the target values displayed in the **Target Selection** screen.
26. Repeat steps (16) to (24) for each of the Cal Ranges associated with the 9500B function that is being calibrated.
27. Repeat steps (14) to (25) for each function of the 9500B which is to be calibrated.
28. Press the **Mode** key to exit from Calibration mode (*refer to Sub-section 10.4, paras 10.4.6 for the processes of date-stamping, altering Cal Due date and setting the advance warning period*).
28. Press either the **PROC** or **MANUAL** screen keys to return the 9500B to normal Procedure Mode or Manual Mode respectively.

### 10.5.2.2 Sequencing Calibrations

The table below indicates the order in which the various Model 9500B functions should be calibrated. Although it is not essential to calibrate all the functions indicated below at any one time, functions higher in the list should be calibrated before those lower in the list.

Sequence	Function	Sub-Section
1	DC/Square: DC Voltage (Positive)	10.5.3
2	DC/Square: DC Voltage (Negative)	10.5.3
3	DC/Square: Square Voltage (Positive)	10.5.4
4	DC/Square: Square Voltage (Negative)	10.5.4
5	DC/Square: Square Voltage (Symmetrical)	10.5.4
6	LF Sine	10.5.5
7	Load Resistance Measurement	10.5.6

**Table 10.5.2.1: Recommended Sequence of Calibrations**

*Final Width = 215mm*

---

### **10.5.3 DC/Square — DC Voltage Calibration**

#### **10.5.3.1 Introduction**

This section is a guide to calibrating the Model 9500B's DC/Square Function, DC Voltage; using its front panel controls. The following topics are covered:

10.5.3.2 Calibration Equipment Requirements

10.5.3.3 Interconnections

10.5.3.4 Calibration Setup

10.5.3.5 Calibration Procedure

#### **10.5.3.2 Calibration Equipment Requirements**

- The UUT Model 9500B with 9510 or 9530 Active Head.
- A high resolution Standards DMM with DC Voltage accuracy of  $\pm 0.005\%$  or better, from 1mV to 200V. For example, a Model 1281 Digital Multimeter.
- An adaptor to convert from BNC to 4mm leads. For example, a Model 4955 Calibration Adaptor.
- Short, high-quality 4mm leads.

*Final Width = 215mm*



### 10.5.3.3 Interconnections

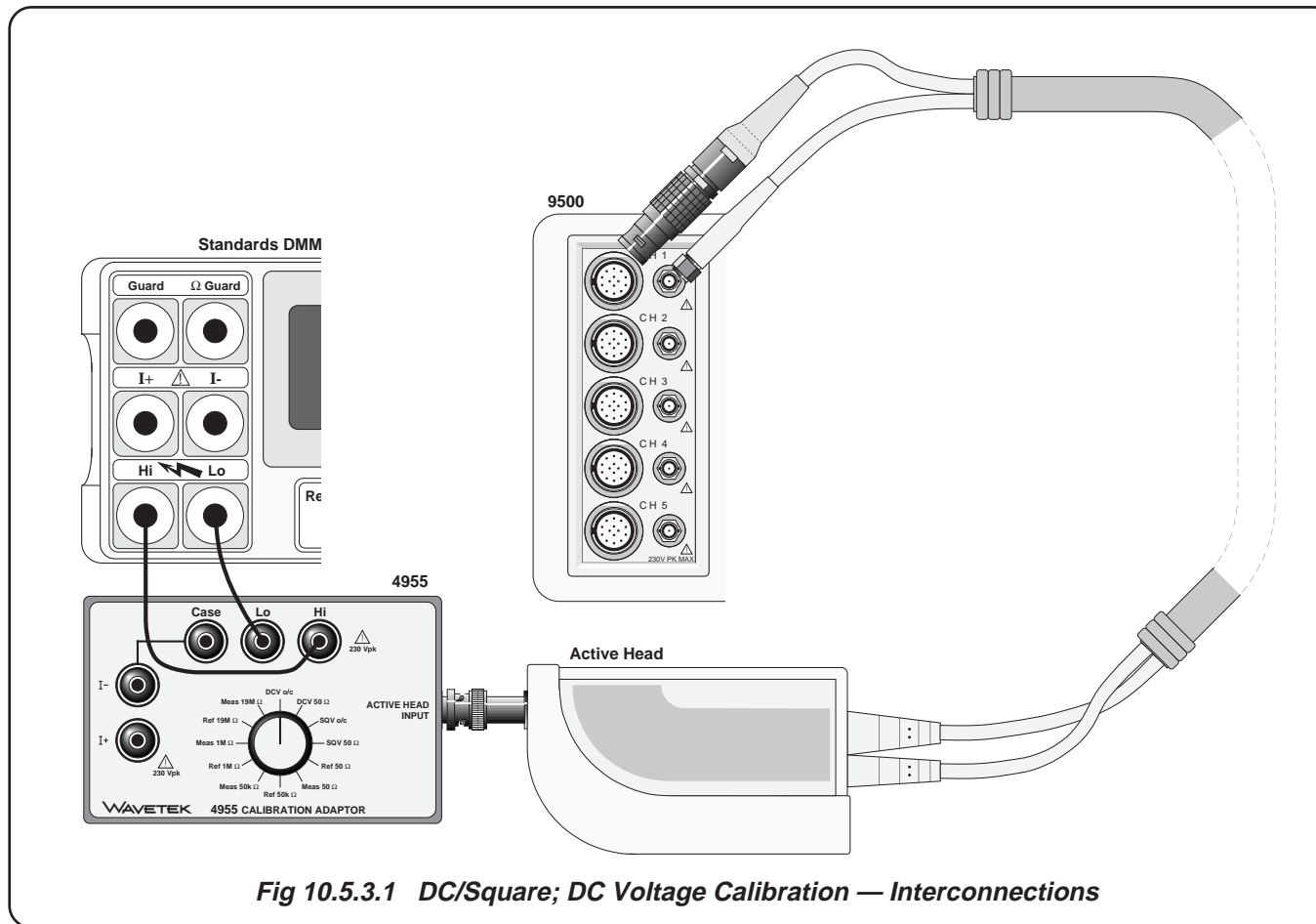

*Final Width = 215mm*

**Fig 10.5.3.1 DC/Square; DC Voltage Calibration — Interconnections**

---

#### 10.5.3.4 Calibration Setup

- 1. Connections** Ensure that the 9500B is connected to the Standards DMM as shown in *Fig. 10.5.3.1*, or via a similar BNC-4mm adaptor, and that both instruments are powered on and warmed up.
- 2. 9500B** Ensure that the 9500B is in BASE CAL mode and then select the DC/Square; DC Voltage (Positive) function (default selection when entering STD CAL). Select the required output Signal Channel (1M $\Omega$  Load), trigger channel and Trigger Ratio (if required) via the **Target Selection** screen.

#### 10.5.3.5 Calibration Procedure

- Starting at Cal Range 1, calibrate at all calibration points listed in *Table 10.5.3.1* by performing operations (2) to (13) below.
  - Select the required 9500B hardware configuration by choosing the appropriate **Cal Range**.
  - For this Cal Range, use (a) or (b):
    - If you wish to use the '**saved**' target calibration points used during the previous calibration of the 9500B, do *not* press the **DEFAULT TARGETS** screen key.
    - If you wish to use the default target calibration points defined for this hardware configuration, *press* the **DEFAULT TARGETS** screen key.
  - Press the **TARGET 1** or **TARGET 2** screen key to display the target's **Adjustment** screen.
- Note:** Omit operation 5 if you do not wish to change the amplitude of this target calibration point.
- If you wish to change the target calibration point amplitude, use the **TAB** (→) key to position the cursor on the **Target Amplitude** value. Now use any editing mode to change this value (note that the new value must lie within the Max and Min limits specified in *Table 10.5.3.1*).
  - Press the **SAVE TARGET** soft key.

- If using the Model 4955 Calibration Adaptor, set its switch to 'DCV o/c'. Otherwise ensure that the DMM input is at high impedance.
  - Set the Standards DMM to the appropriate measurement range.
  - Press the **ON** key to turn the 9500B output on.
  - Press the **TAB** (→) key to return the cursor to the 9500B **O/P Amplitude** display, and increment or decrement this value using the cursor controls and/or spinwheel until the reading on the Standards DMM is the same as the displayed **Target Amplitude** value. (Note: make sure to allow for any settling time required by the external measuring instrument.)
  - When you are satisfied with the measurement, press the **ACCEPT CALIB** key to generate and implement the correction factor required by the 9500B, to ensure that its displayed O/P Amplitude value and measured output value coincide. The **O/P Amplitude** value will change to the **Target Amplitude** value, and the adjustment of the output amplitude at this target is complete.
  - Press the **EXIT** key to turn the 9500B output off and return to the Target Selection screen, .
  - Repeat steps (3) to (11) for each of the target values displayed in the Target Selection screen.
  - Repeat steps (2) to (12) for each of the Cal Ranges detailed in the *Table 10.5.3.1*.
  - On the Target Selection screen, press the WAVEFORM soft key. Select DCV (negative) by pressing the  key on the right of the screen. Repeat steps (2) to (12) for each of the Cal Ranges detailed in the *Table 10.5.3.2*.
- Note:** If other functions are being calibrated in addition to DC Voltage, refer to *Table 10.5.2.1 on page 10.5-3* for information on sequencing calibrations.

*Final Width = 215mm*

**Table 10.5.3.1:**  
**DC/Square; DC Voltage (Positive) Hardware Configurations and Calibration Targets**

Function/ Waveshape	Cal Range	Hardware Configuration Span	Target 1 (low)			Target 2 (high)		
			Default	Minimum	Maximum	Default	Minimum	Maximum
	1	888.00µV - 2.10mV	+1.0000mV	+0.9300mV	+1.0700mV	+1.9000mV	+1.7670mV	+2.0330mV
	2	2.10mV - 5.56mV	+2.3000mV	+2.1390mV	+2.4610mV	+5.0000mV	+4.6500mV	+5.3500mV
	3	5.56mV - 21.00mV	+6.0000mV	+5.5800mV	+6.4200mV	+19.000mV	+17.670mV	+20.330mV
	4	21.00mV - 55.60mV	+23.000mV	+21.390mV	+24.610mV	+50.000mV	+46.500mV	+53.500mV
	5	55.60mV - 210.00mV	+60.000mV	+55.800mV	+64.200mV	+190.00mV	+176.70mV	+203.30mV
	6	210.00mV - 556.00mV	+230.00mV	+213.90mV	+246.10mV	+500.00mV	+465.00mV	+535.00mV
	7	556.00mV - 2.10V	+600.00mV	+558.00mV	+642.00mV	+1.9000V	+1.7670V	+2.0330V
	8	2.10V - 5.56V	+2.3000V	+2.1390V	+2.4610V	+5.0000V	+4.6500V	+5.3500V
	9	5.56V - 22.24V	+6.0000V	+5.5800V	+6.4200V	+19.000V	+17.670V	+20.330V
	10	22.24V - 55.60V	+23.000V	+21.390V	+24.610V	+50.000V	+46.500V	+53.500V
	11	55.60V - 222.40V	+60.000V	+55.800V	+64.200V	+190.00V	+176.70V	+203.30V

**Table 10.5.3.2:**  
**DC/Square; DC Voltage (Negative) Hardware Configurations and Calibration Targets**

Function/ Waveshape	Cal Range	Hardware Configuration Span	Target 1 (low)			Target 2 (high)		
			Default	Minimum	Maximum	Default	Minimum	Maximum
	1	888.00µV - 2.10mV	-1.0000mV	-0.9300mV	-1.0700mV	-1.9000mV	-1.7670mV	-2.0330mV
	2	2.10mV - 5.56mV	-2.3000mV	-2.1390mV	-2.4610mV	-5.0000mV	-4.6500mV	-5.3500mV
	3	5.56mV - 21.00mV	-6.0000mV	-5.5800mV	-6.4200mV	-19.000mV	-17.670mV	-20.330mV
	4	21.00mV - 55.60mV	-23.000mV	-21.390mV	-24.610mV	-50.000mV	-46.500mV	-53.500mV
	5	55.60mV - 210.00mV	-60.000mV	-55.800mV	-64.200mV	-190.00mV	-176.70mV	-203.30mV
	6	210.00mV - 556.00mV	-230.00mV	-213.90mV	-246.10mV	-500.00mV	-465.00mV	-535.00mV
	7	556.00mV - 2.10V	-600.00mV	-558.00mV	-642.00mV	-1.9000V	-1.7670V	-2.0330V
	8	2.10V - 5.56V	-2.3000V	-2.1390V	-2.4610V	-5.0000V	-4.6500V	-5.3500V
	9	5.56V - 22.24V	-6.0000V	-5.5800V	-6.4200V	-19.000V	-17.670V	-20.330V
	10	22.24V - 55.60V	-23.000V	-21.390V	-24.610V	-50.000V	-46.500V	-53.500V
	11	55.60V - 222.40V	-60.000V	-55.800V	-64.200V	-190.00V	-176.70V	-203.30V

Final Width = 215mm

---

## 10.5.4 DC/Square — Square Calibration

### 10.5.4.1 Introduction

This section is a guide to calibrating the Model 9500B's DC/Square Function, Square Waveform; using its front panel controls. The following topics are covered:

10.5.4.2 Calibration Equipment Requirements

10.5.4.3 Interconnections

10.5.4.4 Calibration Setup

10.5.4.5 Calibration Procedure

### 10.5.4.2 Calibration Equipment Requirements

- The UUT Model 9500B with 9510 or 9530 Active Head.
- A high resolution Standards DMM with RMS AC Voltage accuracy of  $\pm 0.01\%$  or better, from 2.5mV to 35V, at 1kHz.  
For example: Model 1281 Digital Multimeter.
- An adaptor to convert from BNC to 4mm leads.  
For example, a Model 4955 Calibration Adaptor.
- Short, high-quality 4mm leads.

*Final Width = 215mm*

### 10.5.4.3 Interconnections

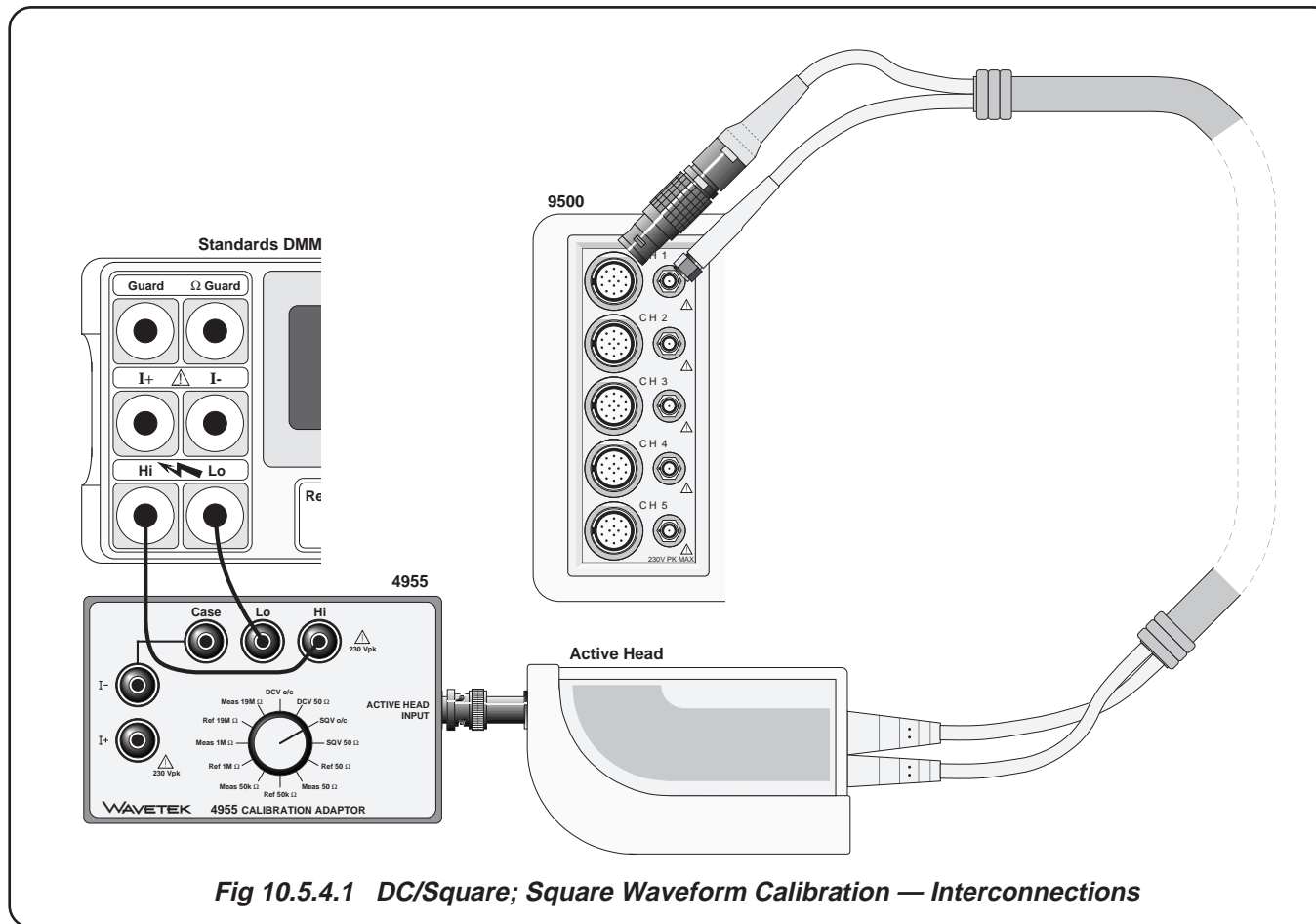

*Final Width = 215mm*

---



#### 10.5.4.4 Calibration Setup

- 1. Connections** Ensure that the 9500B is connected to the Standards DMM as shown in *Fig. 10.5.4.1*, or via a similar BNC-4mm adaptor, and that both instruments are powered on and warmed up.
- 2. 9500B** Ensure that the 9500B is in BASE CAL mode and then select the DC/Square; Square Waveform (Positive) function (From entry default, in the **Target Selection** screen, press the WAVEFORM soft key and then press the  soft key on the right of the screen). Select the required output Signal Channel (1MΩ Load), trigger channel and Trigger Ratio (if required) via the **Target Selection** screen.



#### 10.5.4.5 Calibration Procedure

- Starting at Cal Range 1, calibrate at all calibration points listed in *Table 10.5.4.1* by performing operations (2) to (13) below.
- Select the required 9500B hardware configuration by choosing the appropriate **Cal Range**.
- For this Cal Range, use (a) or (b):
  - If you wish to use the 'saved' target calibration points used during the previous calibration of the 9500B, do *not* press the **DEFAULT TARGETS** screen key.
  - If you wish to use the default target calibration points defined for this hardware configuration, *press* the **DEFAULT TARGETS** screen key.
- Press the **TARGET 1** or **TARGET 2** screen key to display the target's **Adjustment** screen.

**Note:** Omit operation 5 if you do not wish to change the amplitude of this target calibration point. The frequency is fixed and cannot be changed.

- If you wish to change the target calibration point frequency, use the **TAB**  key to position the cursor on the **Frequency** value. Now use any editing mode to change this value (note that the new value must lie within the Max and Min limits specified in *Table 10.5.4.1*).
  - If you wish to change the target calibration point amplitude, use the **TAB**  key to position the cursor on the **Target Amplitude** value. Now use any editing mode to change this value (note that the new value must lie within the Max and Min limits specified in *Table 10.5.4.1*).
  - Press the **SAVE TARGET** soft key.
- If using the Model 4955 Calibration Adaptor, set its switch to 'SQV o/c'. If not using the Model 4955, ensure that the DMM input is AC-coupled at high impedance.
  - Set the Standards DMM to the appropriate RMS voltage measurement range.
  - Calculate the RMS value of the 9500B output pk-pk voltage from the following factor:  
(at 1kHz,  $RMS = 0.5 \times 0.999917 \times pk-pk$ );  
**Note:** This factor applies only at 1kHz and assumes use of model 4955 set to 'SQV o/c'. A compensation of 83ppm accounts the finite transition time of the Square Wave and the resultant fall in its RMS value.
  - Press the **ON** key to turn the 9500B output on.
  - Press the **TAB**  key to return the cursor to the 9500B **O/P Amplitude** display, and increment or decrement this value using the cursor controls and/or spinwheel until the reading on the Standards DMM is the RMS equivalent of the displayed **Target Amplitude** pk-pk value calculated in operation (8). (Note: make sure to allow for any settling time of the external measuring instrument - approx 30-40 secs.)

*Final Width = 215mm*

11. When you are satisfied with the measurement, press the **ACCEPT CALIB** key to generate and implement the correction factor required by the 9500B, to ensure that its displayed O/P Amplitude value and measured output value coincide. The **O/P Amplitude** value will change to the **Target Amplitude** value, and the adjustment of the output amplitude at this target is complete.
  12. Press the **EXIT** key to turn the 9500B output off and return to the Target Selection screen. .
  13. Repeat steps (3) to (12) for each of the target values displayed in the Target Selection screen.
  14. Repeat steps (2) to (13) for each of the Cal Ranges detailed in the *Table 10.5.4.1*.
  15. On the Target Selection screen, press the WAVEFORM soft key. Select Square (negative) by pressing the  key on the right of the screen. Repeat steps (1) to (14), but using *Table 10.5.4.2* for each of the Cal Ranges, Targets and Limits.
  16. On the Target Selection screen, press the WAVEFORM soft key. Select Square (symmetrical) by pressing the  key on the right of the screen. Repeat steps (1) to (14), but using *Table 10.5.4.3* for each of the Cal Ranges, Targets and Limits.
- Note:** If other functions are being calibrated in addition to Square Waveform, refer to *Table 10.5.2.1 on page 10.5-5* for information on sequencing calibrations.

**Table 10.5.4.1: DC/Square; Square Waveform (Positive) Hardware Configurations and Calibration Targets**

Function/ Waveshape	Cal Range	Frequency Target			Hardware Configuration Span	Target 1 (low) pk-pk			Target 2 (high) pk-pk		
		Default	Minimum	Maximum		Default	Minimum	Maximum	Default	Minimum	Maximum
	1	1kHz	0.9500BkHz	1.0500kHz	556.01µV - 2.10mV	800.00µV	744.00µV	856.00µV	1.9000mV	1.7670mV	2.0330mV
	2	1kHz	0.9500BkHz	1.0500kHz	2.10mV - 5.56mV	2.3000mV	2.1390mV	2.4610mV	5.0000mV	4.6500mV	5.3500mV
	3	1kHz	0.9500BkHz	1.0500kHz	5.56mV - 21.00mV	6.0000mV	5.5800mV	6.4200mV	19.000mV	17.670mV	20.330mV
	4	1kHz	0.9500BkHz	1.0500kHz	21.00mV - 55.60mV	23.000mV	21.390mV	24.610mV	50.000mV	46.500mV	53.500mV
	5	1kHz	0.9500BkHz	1.0500kHz	55.60mV - 210.00mV	60.000mV	55.800mV	64.200mV	190.00mV	176.70mV	203.30mV
	6	1kHz	0.9500BkHz	1.0500kHz	210.00mV - 556.00mV	230.00mV	213.90mV	246.10mV	500.00mV	465.00mV	535.00mV
	7	1kHz	0.9500BkHz	1.0500kHz	556.00mV - 2.10V	600.00mV	558.00mV	642.00mV	1.9000V	1.7670V	2.0330V
	8	1kHz	0.9500BkHz	1.0500kHz	2.10V - 5.56V	2.3000V	2.1390V	2.4610V	5.0000V	4.6500V	5.3500V
	9	1kHz	0.9500BkHz	1.0500kHz	5.56V - 22.24V	6.0000V	5.5800V	6.4200V	19.000V	17.670V	20.330V
	10	1kHz	0.9500BkHz	1.0500kHz	22.24V - 55.60V	23.000V	21.390V	24.610V	50.000V	46.500V	53.500V
	11	1kHz	0.9500BkHz	1.0500kHz	55.60V - 222.40V	60.000V	55.800V	64.200V	190.00V	176.70V	203.30V

Final Width = 215mm

Tables 10.5.4.2 and 10.5.4.3 overleaf→

**Table 10.5.4.2: DC/Square; Square Waveform (Negative) Hardware Configurations and Calibration Targets**

Function/ Waveshape	Cal Range	Frequency Target			Hardware Configuration Span	Target 1 (low)			Target 2 (high)		
		Default	Minimum	Maximum		Default	Minimum	Maximum	Default	Minimum	Maximum
	1	1kHz	0.9500BkHz	1.0500kHz	556.01µV - 2.10mV	800.00µV	744.00µV	856.00µV	1.9000mV	1.7670mV	2.0330mV
	2	1kHz	0.9500BkHz	1.0500kHz	2.10mV - 5.56mV	2.3000mV	2.1390mV	2.4610mV	5.0000mV	4.6500mV	5.3500mV
	3	1kHz	0.9500BkHz	1.0500kHz	5.56mV - 21.00mV	6.0000mV	5.5800mV	6.4200mV	19.000mV	17.670mV	20.330mV
	4	1kHz	0.9500BkHz	1.0500kHz	21.00mV - 55.60mV	23.000mV	21.390mV	24.610mV	50.000mV	46.500mV	53.500mV
	5	1kHz	0.9500BkHz	1.0500kHz	55.60mV - 210.00mV	60.000mV	55.800mV	64.200mV	190.00mV	176.70mV	203.30mV
	6	1kHz	0.9500BkHz	1.0500kHz	210.00mV - 556.00mV	230.00mV	213.90mV	246.10mV	500.00mV	465.00mV	535.00mV
	7	1kHz	0.9500BkHz	1.0500kHz	556.00mV - 2.10V	600.00mV	558.00mV	642.00mV	1.9000V	1.7670V	2.0330V
	8	1kHz	0.9500BkHz	1.0500kHz	2.10V - 5.56V	2.3000V	2.1390V	2.4610V	5.0000V	4.6500V	5.3500V
	9	1kHz	0.9500BkHz	1.0500kHz	5.56V - 22.24V	6.0000V	5.5800V	6.4200V	19.000V	17.670V	20.330V
	10	1kHz	0.9500BkHz	1.0500kHz	22.24V - 55.60V	23.000V	21.390V	24.610V	50.000V	46.500V	53.500V
	11	1kHz	0.9500BkHz	1.0500kHz	55.60V - 222.40V	60.000V	55.800V	64.200V	190.00V	176.70V	203.30V

**Table 10.5.4.3: DC/Square; Square Waveform (Symmetrical) Hardware Configurations and Calibration Targets**

Function/ Waveshape	Cal Range	Frequency Target			Hardware Configuration Span	Target 1 (low)			Target 2 (high)		
		Default	Minimum	Maximum		Default	Minimum	Maximum	Default	Minimum	Maximum
	1	1kHz	0.9500BkHz	1.0500kHz	556.01µV - 2.10mV	800.00µV	744.00µV	856.00µV	1.9000mV	1.7670mV	2.0330mV
	2	1kHz	0.9500BkHz	1.0500kHz	2.10mV - 5.56mV	2.3000mV	2.1390mV	2.4610mV	5.0000mV	4.6500mV	5.3500mV
	3	1kHz	0.9500BkHz	1.0500kHz	5.56mV - 21.00mV	6.0000mV	5.5800mV	6.4200mV	19.000mV	17.670mV	20.330mV
	4	1kHz	0.9500BkHz	1.0500kHz	21.00mV - 55.60mV	23.000mV	21.390mV	24.610mV	50.000mV	46.500mV	53.500mV
	5	1kHz	0.9500BkHz	1.0500kHz	55.60mV - 210.00mV	60.000mV	55.800mV	64.200mV	190.00mV	176.70mV	203.30mV
	6	1kHz	0.9500BkHz	1.0500kHz	210.00mV - 556.00mV	230.00mV	213.90mV	246.10mV	500.00mV	465.00mV	535.00mV
	7	1kHz	0.9500BkHz	1.0500kHz	556.00mV - 2.10V	600.00mV	558.00mV	642.00mV	1.9000V	1.7670V	2.0330V
	8	1kHz	0.9500BkHz	1.0500kHz	2.10V - 5.56V	2.3000V	2.1390V	2.4610V	5.0000V	4.6500V	5.3500V
	9	1kHz	0.9500BkHz	1.0500kHz	5.56V - 22.24V	6.0000V	5.5800V	6.4200V	19.000V	17.670V	20.330V
	10	1kHz	0.9500BkHz	1.0500kHz	22.24V - 55.60V	23.000V	21.390V	24.610V	50.000V	46.500V	53.500V
	11	1kHz	0.9500BkHz	1.0500kHz	55.60V - 222.40V	60.000V	55.800V	64.200V	190.00V	176.70V	203.30V

Final Width = 215mm



---

## 10.5.5 LF Sine Voltage Calibration

### 10.5.5.1 Introduction

This section is a guide to calibrating the Model 9500B's LF Sine Function; using its front panel controls. The following topics are covered:

- 10.5.5.2 Calibration Equipment Requirements
- 10.5.5.3 Interconnections
- 10.5.5.4 Calibration Setup
- 10.5.5.5 Calibration Procedure

### 10.5.5.2 Calibration Equipment Requirements

- The UUT Model 9500B with Active Head.
- A high resolution Standards DMM with RMS AC Voltage accuracy of  $\pm 0.3\%$  or better, between 0.5V and 2V, at 1kHz and 45kHz. For example, a Model 1281 Digital Multimeter.
- An adaptor to convert from BNC to 4mm leads, incorporating a  $50\Omega$  load. For example, a Model 4955 Calibration Adaptor.
- Short, high-quality 4mm leads.

*Final Width = 215mm*

### 10.5.5.3 Interconnections

Final Width = 215mm

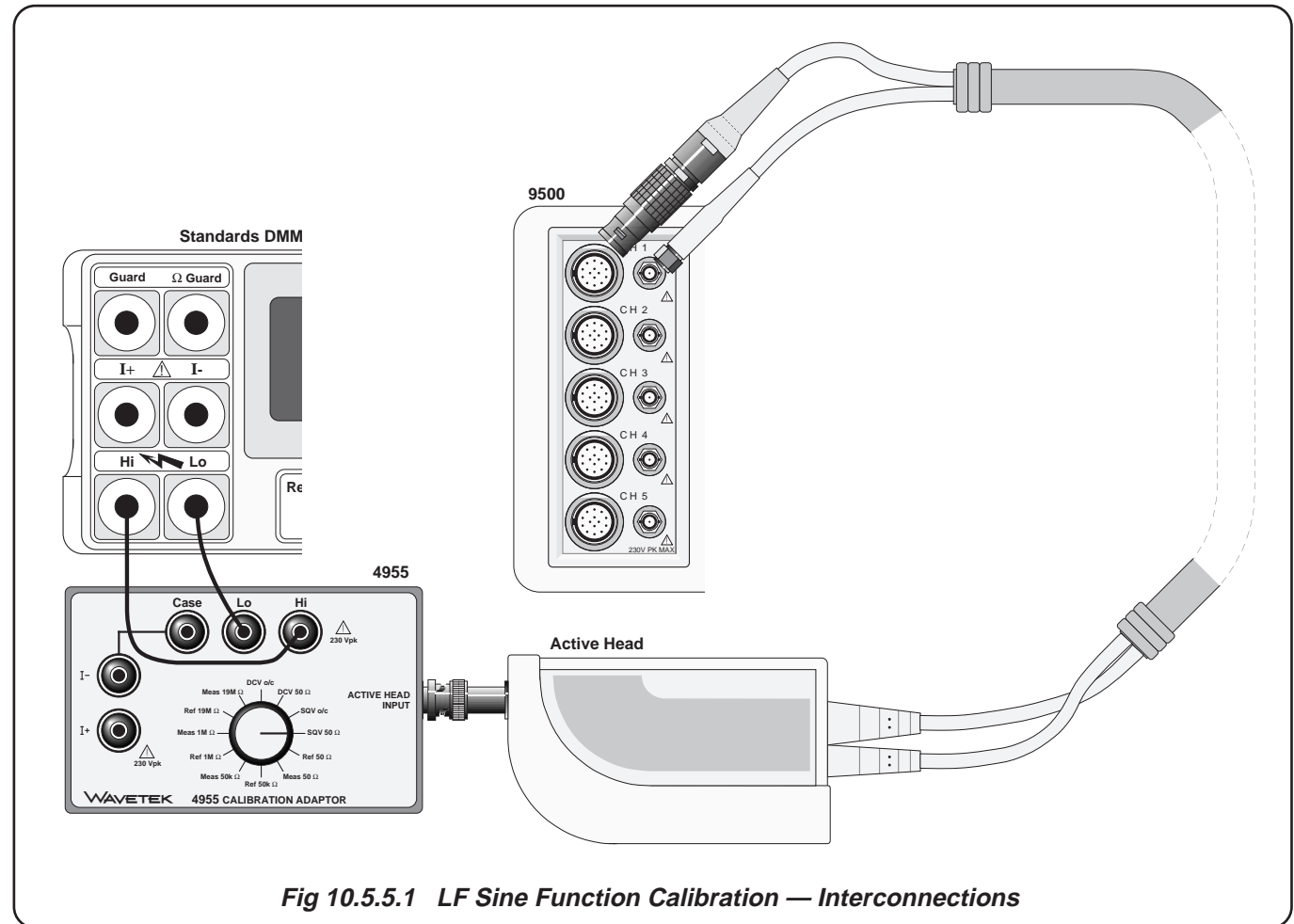

Fig 10.5.5.1 LF Sine Function Calibration — Interconnections

### 10.5.5.4 Calibration Setup

#### 1. Connections

Ensure that the 9500B is connected to the Standards DMM as shown in Fig. 10.5.5.1, or via a similar BNC-4mm adaptor and 50Ω load, and that both instruments are powered on and warmed up.

#### 2. 9500B

Ensure that the 9500B is in BASE CAL mode and then select the LF Sine function (From entry default, in the **Target Selection** screen, press the  $\sim$  key on the right of the Front Panel). Select the required output Signal Channel (50Ω Load), trigger channel and Trigger Ratio (if required) via the **Target Selection** screen.

### 10.5.5.5 Calibration Procedure

- Starting at Cal Range 1, calibrate at all calibration points listed in *Table 10.5.5.1* by performing operations (2) to (13) below.
- Select the required 9500B hardware configuration by choosing the appropriate **Cal Range**.

3. For this Cal Range, use (a) or (b):

- If you wish to use the 'saved' target calibration points used during the previous calibration of the 9500B, do *not* press the **DEFAULT TARGETS** screen key.
- If you wish to use the default target calibration points defined for this hardware configuration, *press* the **DEFAULT TARGETS** screen key.

4. Press the **TARGET 1**, **TARGET 2**, **TARGET 3** or **TARGET 2** screen key to display the target's **Adjustment** screen.

**Note:** Omit operation 5 if you do not wish to change the frequency or amplitude of this target calibration point.

- If you wish to change the target calibration point frequency, use the **TAB** (←) key to position the cursor on the **Frequency** value. Now use any editing mode to change this value (note that the new value must lie within the Max and Min limits specified in *Table 10.5.5.1*).
- If you wish to change the target calibration point amplitude, use the **TAB** (→) key to position the cursor on the **Target Amplitude** value. Now use any editing mode to change this value (note that the new value must lie within the Max and Min limits specified in *Table 10.5.5.1*).
- Press the **SAVE TARGET** soft key.

6. If using the Model 4955 Calibration Adaptor, set its switch to 'SQV 50 Ω'. If not using the Model 4955, ensure that the DMM input is AC-coupled using an external 50Ω load impedance.

7. Set the Standards DMM to the appropriate RMS voltage measurement range.

8. Calculate the RMS value of the 9500B output pk-pk voltage from the following factor:

$$(RMS = 0.5 \times 0.70710 \times \text{pk-pk})$$

**Note:** The above figure applies only when the Standards DMM input is AC-Coupled.

9. Press the **ON** key to turn the 9500B output on.

10. Press the **TAB** (↔) key to return the cursor to the 9500B **O/P Amplitude** display, and increment or decrement this value using the cursor controls and/or spinwheel until the reading on the Standards DMM is the RMS equivalent of the displayed **Target Amplitude** pk-pk value calculated in operation (8). (Note: make sure to allow for any settling time of the external measuring instrument - approx 60 secs.)

11. When you are satisfied with the measurement, press the **ACCEPT CALIB** key to generate and implement the correction factor required by the 9500B, to ensure that its displayed O/P Amplitude value and measured output value coincide. The **O/P Amplitude** value will change to the **Target Amplitude** value, and the adjustment of the output amplitude at this target is complete.

12. Press the **EXIT** key to turn the 9500B output off and return to the Target Selection screen, .

13. Repeat steps (3) to (12) for each of the target values displayed in the Target Selection screen.

14. Repeat steps (2) to (13) for each of the Cal Ranges detailed in the *Table 10.5.5.1*.

**Note:** If other functions are being calibrated in addition to Square Waveform, refer to *Table 10.5.2.1* on page 10.5-5 for information on sequencing calibrations.

*Final Width = 215mm*

**Table 10.5.5.1: LF Sine Function; Hardware Configurations and Calibration Targets**

Function/ Waveshape	Cal Range	Target No	Target Frequency			Hardware Configuration Span	Target Amplitude		
			Default	Minimum	Maximum		Default	Minimum	Maximum
	1	1	1.000kHz	0.900kHz	1.100kHz	1.400V - 2.224V	1.6000V	1.5500V	1.7000V
		2	1.000kHz	0.900kHz	1.100kHz	1.400V - 2.224V	1.9000V	1.8000V	2.0000V
		3	45.000kHz	44.000kHz	46.000kHz	1.400V - 2.224V	1.6000V	1.5500V	1.7000V
		4	45.000kHz	44.000kHz	46.000kHz	1.400V - 2.224V	1.9000V	1.8000V	2.0000V
	2	1	1.000kHz	0.900kHz	1.100kHz	2.224V - 5.56V	2.6000V	2.5500V	3.0000V
		2	1.000kHz	0.900kHz	1.100kHz	2.224V - 5.56V	4.8000V	4.2000V	5.0000V
		3	45.000kHz	44.000kHz	46.000kHz	2.224V - 5.56V	2.6000V	2.5500V	3.0000V
		4	45.000kHz	44.000kHz	46.000kHz	2.224V - 5.56V	4.8000V	4.2000V	5.0000V

---

## 10.5.6 Load Resistance Measurement Calibration

### 10.5.6.1 Introduction

This section is a guide to calibrating the Model 9500B's Load Resistance Measurement Function; using its front panel controls. The following topics are covered:

10.5.6.2 Calibration Equipment Requirements

10.5.6.3 Interconnections

10.5.6.4 Calibration Setup

10.5.6.5 Calibration Procedure

### 10.5.6.2 Calibration Equipment Requirements

- The UUT Model 9500B with 9510 or 9530 Active Head.
- A traceable, high-resolution Standards DMM, used to measure resistance at 50 $\Omega$ , 50k $\Omega$ , 1M $\Omega$  and 19M $\Omega$ , with an accuracy of 0.02% or better. For example, a Model 1281 Digital Multimeter.
- An adaptor to convert from BNC to 4mm leads, incorporating switchable 50 $\Omega$ , 50k $\Omega$ , 1M $\Omega$  and 19M $\Omega$  loads. For example, a Model 4955 Calibration Adaptor.
- Short, high-quality 4mm leads.

*Final Width = 215mm*

### 10.5.6.3 Interconnections

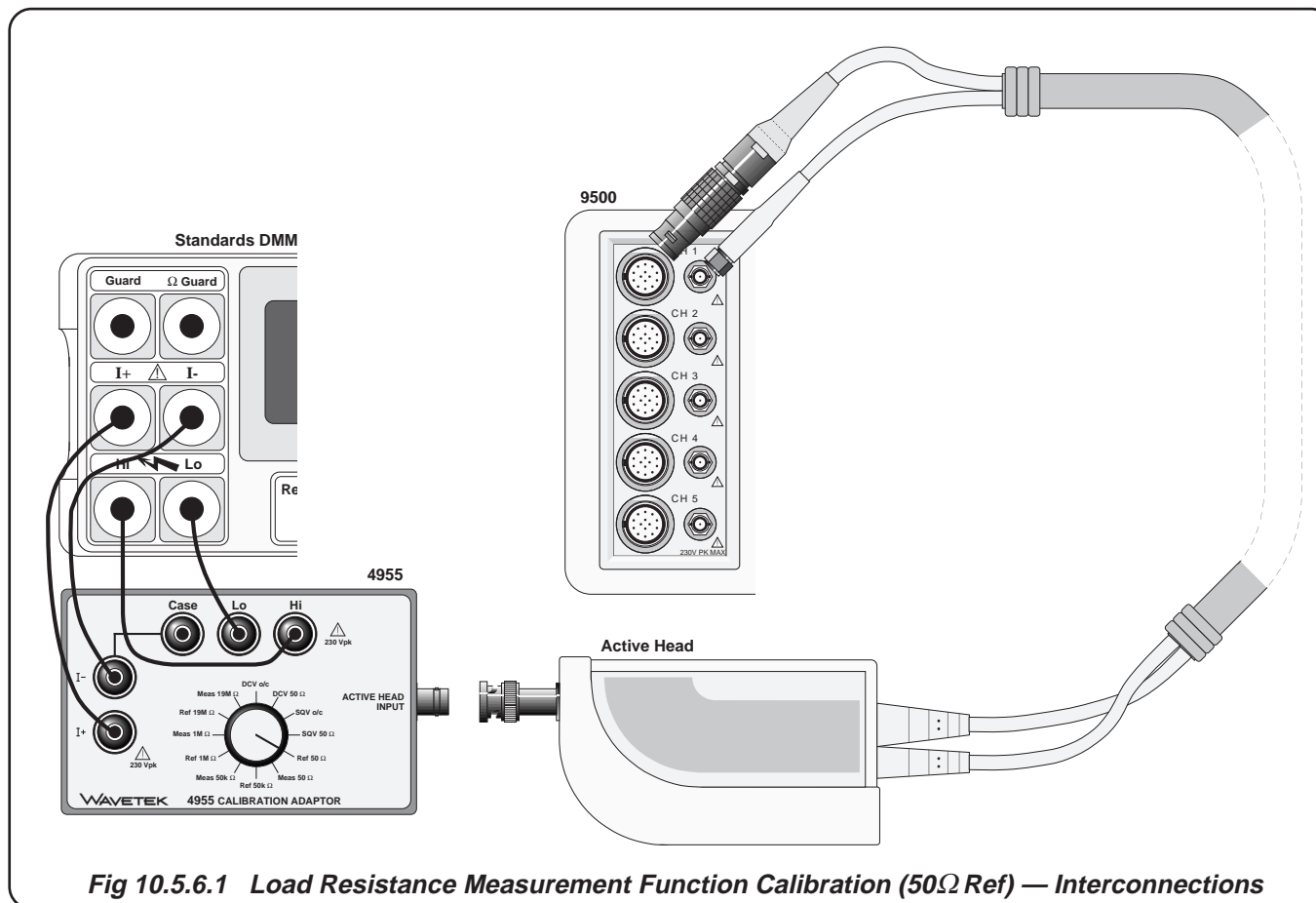

### 10.5.6.4 Calibration Setup

#### 1. Connections

Ensure that the 9500B is connected to the Standards DMM as shown in *Fig. 10.5.6.1*, or via a similar BNC-4mm adaptor and 50Ω load, and that both instruments are powered on and warmed up.

#### 2. 9500B

Ensure that the 9500B is in BASE CAL mode and then select the Load Resistance Measurement function (From entry default, in the **Target Selection** screen, press the **Aux** key on the right of the Front Panel). Select the required output Signal Channel via the **Target Selection** screen.

Final Width = 215mm

### 10.5.6.5 Calibration Procedure

1. Starting at Target 1, calibrate at all calibration points listed in *Table 10.5.6.1* by performing operations (2) to (15) below.
  2. Use (a) or (b):
    - a) If you wish to use the 'saved' target calibration points used during the previous calibration of the 9500B, do *not* press the **DEFAULT TARGETS** screen key.
    - b) If you wish to use the default target calibration points, *press* the **DEFAULT TARGETS** screen key.  
Saved/default targets should be considered as nominal values, with the actual value being used during calibration, which is typically not saved at step 13.
  3. Select the required load resistance by choosing the appropriate **TARGET 1, TARGET 2, TARGET 3** or **TARGET 4** screen key to display the target's **Adjustment** screen.
- Note:** Omit operation (4) if you do not wish to change the resistance value of this target calibration point.
4. a) If you wish to alter the target resistance, use any editing mode to change this value (note that the new value must lie within the Max and Min limits specified in *Table 10.5.6.1*).
  - b) Press the **SAVE TARGET** soft key.
  5. If using the Model 4955 Calibration Adaptor:
    - a) Ensure that the Active Head output BNC is disconnected from the Model 4955 input.
    - b) Set the Model 4955 Calibration Adaptor switch as shown in *Table 10.5.6.1*.
  6. If not using the Model 4955, set up external circuitry to measure the appropriate load resistor (4-wire connection), with the 9500B Active Head output BNC disconnected.
  7. Set the Standards DMM to the appropriate Resistance measurement range, take a Resistance measurement and note the result.  
**Note:** make sure to allow for any settling time of the external measuring instrument.
  8. If using the Model 4955 Calibration Adaptor:
    - a) Set the Model 4955 Calibration Adaptor switch as shown in *Table 10.5.6.1*.
    - b) Reconnect the Active Head output BNC to the Model 4955 input.
  9. If not using the Model 4955, disconnect the load resistor from the DMM, and reconnect it to the 9500B Active Head output BNC.
  10. Press the **ON** key to turn the 9500B output on.
  11. Set the **Target Res** to the value measured in operation (7), using the cursor controls and/or spinwheel.
  12. Press the **ACCEPT CALIB** key to generate and implement the correction factor. The **Measured Res** value will change to the **Target Res** value, and the adjustment of the output amplitude at this target is complete.  
**Note:** Omit operation (13) if you do not wish to save the resistance value of this target calibration point.
  13. Press the **SAVE TARGET** soft key.
  14. Press the **EXIT** key to turn the 9500B output off and return to the Target Selection screen, .
  15. Repeat steps (2) to (14) for each of the target values displayed on the **Target Selection** screen (also see *Table 10.5.6.1* below).  
**Note:** If other functions are being calibrated in addition to Square Waveform, refer to *Table 10.5.2.1* on page 10.5-5 for information on sequencing calibrations.

**Table 10.5.6.1: Load Resistance Measurement Function; Calibration Targets**

Function	Target No	Target Resistance			4955 Switch Positions	
		Default	Minimum	Maximum	Op. 5 (b)	Op. 8 (a)
	1	50.000Ω	45.000Ω	55.000Ω	Ref 50 Ω	Meas 50 Ω
	2	50.000kΩ	45.000kΩ	55.000kΩ	Ref 50k Ω	Meas 50k Ω
	3	1.0000MΩ	0.9000MΩ	1.1000MΩ	Ref 1M Ω	Meas 1M Ω
	4	19.000MΩ	18.000MΩ	19.900MΩ	Ref 19M Ω	Meas 19M Ω

## 10.6 9510/9530/9550/9560 Head Calibration Procedures

Sub-section 10.6 is a guide to the process of calibrating the Model 9510, 9530, 9550 and 9560 Head functions from the front panel. The following topics are covered:

- 10.6.1 Levelled Sine Function: LF Gain Calibration
- 10.6.2 Levelled Sine Function: HF Calibration
- 10.6.3 Edge Function Calibration
- 10.6.4 Calibrating the Timing Markers
- 10.6.5 Load Capacitance Calibration
- 10.6.6 50Ω/1MΩ Ratio Calibration
- 10.6.7 Exit from Head Calibration

The list of topics above are placed in the order in which the 9500B Head functions should be calibrated. Head calibration involves the use of a verified 9500B Mainframe.

**Note:** Heads can be calibrated only within the bandwidth of the mainframe (see *table 10.6.1.1*).  
e.g. Head Model 9510 with Mainframe Variant 9500B/600 can only be verified to 600MHz.

**Table 10.6.1.1: Head Calibration and Base Compatibility**

Model:	9510	9530	9550	9560
400MHz base	<i>no</i>	<i>no</i>	<i>yes</i>	<i>no</i>
600MHz base	<i>no</i>	<i>no</i>	<i>yes</i>	<i>no</i>
1.1GHz base	<i>yes</i>	<i>no</i>	<i>yes</i>	<i>no</i>
3.2GHz base	<i>yes</i>	<i>yes</i>	<i>yes</i>	<i>yes</i>

### 10.6.1 Levelled Sine Function: LF Gain

#### 10.6.1.1 Summary

The Levelled Sine Function LF Gain is calibrated by carrying out the sequences given in section *10.6.1.4*.

Equipment requirements are for LF Gain calibration are given in *para 10.6.1.2* and calibration setup in *para 10.6.1.3*.

#### 10.6.1.2 Equipment Requirements

- The UUT Active Head, connected to a verified Model 9500B Mainframe.
- A high resolution Standards DMM with RMS AC Voltage accuracy of  $\pm 0.3\%$  or better, from 10mV to 3V at 1kHz.  
*Example: Model 1281 Digital Multimeter.*
- An adaptor to convert from BNC or PC3.5 to 4mm leads.  
*Example: Model 4955 Calibration Adaptor.*
- Short, high-quality 4mm leads for connection between the Calibration Adaptor the DMM.

*Final Width = 215mm*

#### 10.6.1.3 Calibration Setup

1. **Connections** Ensure that the 9500B is connected to the DMM as shown in *Fig. 10.6.1.1* overleaf, or via a similar BNC or PC3.5 to 4mm adaptor, and that both instruments are powered on and warmed up.

Final Width = 215mm

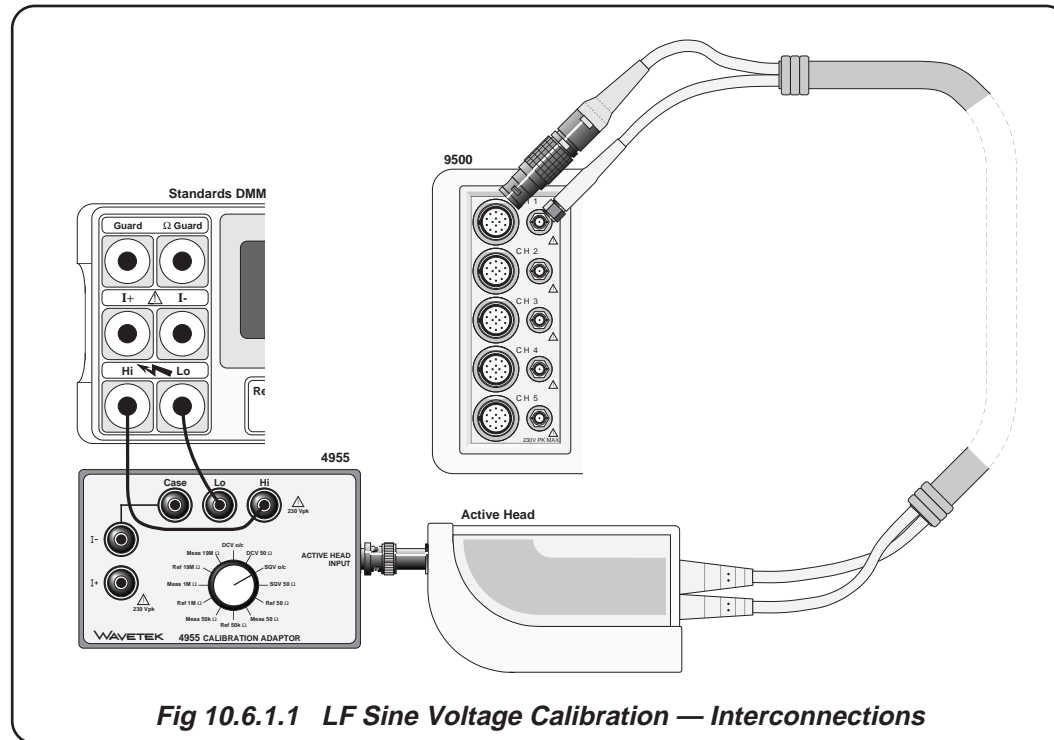

Fig 10.6.1.1 LF Sine Voltage Calibration — Interconnections

#### 10.6.1.4 Calibration Procedure: LF Gain

1. Ensure that the 9500B is in HEAD CAL mode, then select Sine, Lo Frq Sine function.
2. Select TARGET 1.
3. Set output ON and wait for DMM reading to settle.
4. If using the Model 4955 Calibration Adapter, set its switch to 'SQV o/c' according to table 10.6.1.2. If not using the Model 4955, ensure that the DMM input is AC-coupled at 50Ω or 1MΩ input impedance as shown in table 10.6.1.2.
5. Select the correct RMS Voltage range for the calibration point RMS Output Voltage.
6. Adjust the 9500B's output amplitude until the DMM reads the same as the Target Amplitude on the 9500B:  

$$\text{pk-pk Voltage} = 2 * \sqrt{2} * \text{RMS Voltage}$$
7. Press **ACCEPT CALIB**.
8. Select next TARGET and return to step 4; repeat until no TARGETs remain.

Table 10.6.1.2: Levelled Sine Function: LF Gain

Cal. Point	Frequency	O/P Volts	O/P Load
Target 1	1kHz	3.0000V	50Ω
Target 2	1kHz	1.0072V	50Ω
Target 3	1kHz	316.49mV	50Ω
Target 4	1kHz	316.49mV	50Ω
Target 5	1kHz	3.0000V	1MΩ



## 10.6.2 Levelled Sine Function: HF Calibration

### 10.6.2.1 Summary

The Levelled Sine Function HF calibration is calibrated by carrying out the sequences given in sections 10.6.2.4 through 10.6.2.7. The 3GHz calibrations described in Sections 10.6.2.6 and 10.6.2.7 only apply to model 9530 Heads and the 6GHz only applies to model 9560 heads.

Equipment requirements are for LF Gain calibration are given in para 10.6.2.2 and calibration setup in para 10.6.2.3.

### 10.6.2.2 Equipment Requirements

- The UUT Active Head, connected to a verified Model 9500B Mainframe.
- RF Power Meter for Power measurements from 50kHz to 6GHz and from 20mVp-p to 5.5Vp-p into 50Ω.  
Example: *Marconi RF Power Meter model 6960B.*  
*Rhode & Swartz NRVZ with NRV-25 Head*
- Precision-N to BNC or PC3.5 Adapter for signal connection from the UUT Active Head to the input of the RF Power Meter head for Amplitude measurements.  
Example: *Huber & Suhner Adapter type no. 31BNC-N-50-51*  
*or 31N-PC3.5-50-1.*

### 10.6.2.3 Calibration Setup

#### Connections

Ensure that the 9500B is connected to the RF Power Meter as shown in Fig. 10.6.2.1, and that both instruments are powered on and warmed up.

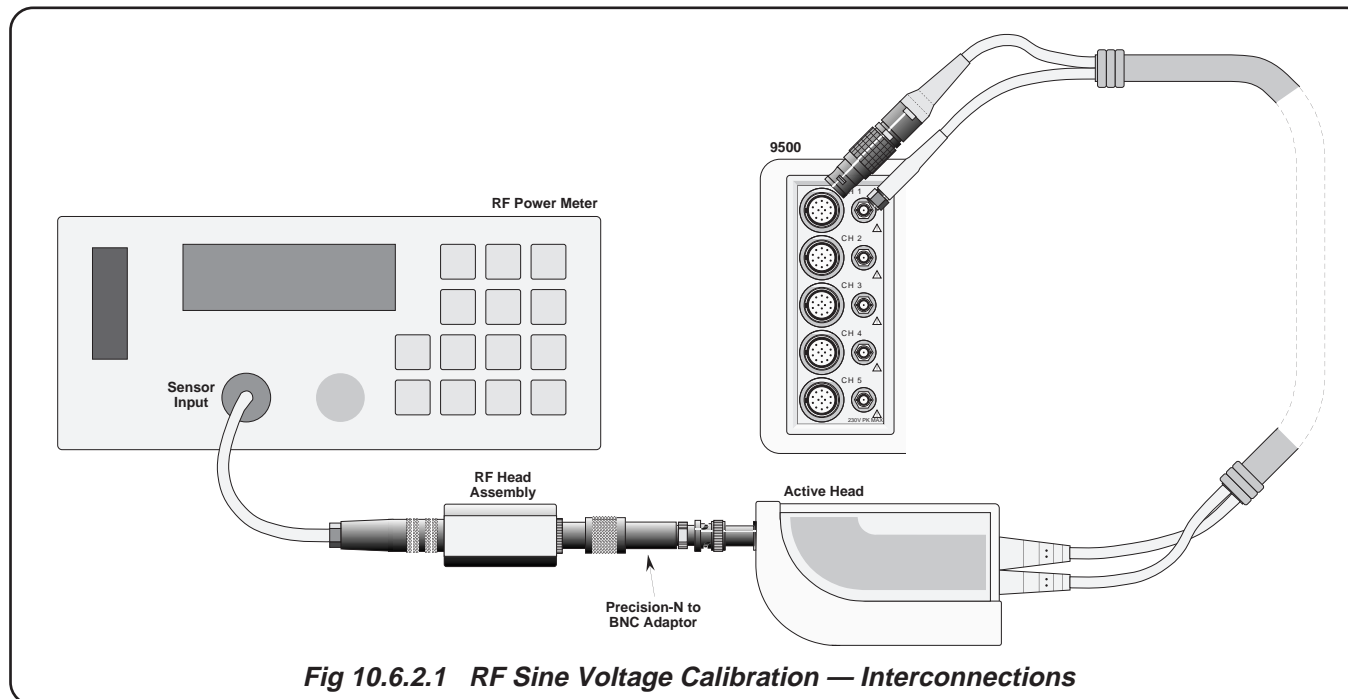

Fig 10.6.2.1 RF Sine Voltage Calibration — Interconnections

Final Width = 215mm

#### 10.6.2.4 Calibration Procedure: HF Linearity

1. **9500B:** Ensure that the 9500B is in HEAD CAL, Sine, Hi Frq Sine mode, LIN.
2. The following process takes you through all TARGETs in *table 10.6.2.1*.
3. **9500B:** Set Output ON.
4. **Power Meter:** Select a range that gives an on-scale reading.
5. Adjust the 9500B's output amplitude to give a reading equal to Target Amplitude on the measuring device. The conversion from power to pk-pk voltage is  $\text{pk-pk Voltage} = \sqrt{(\text{power}) * 20}$ .
6. Press **ACCEPT CALIB**.
7. Select the next TARGET and return to step 4; repeat until no TARGETs remain.

#### 10.6.2.5 Calibration Procedure: Levelled Sine Function: HF Flatness

1. **9500B:** Ensure that the 9500B is in HEAD CAL, Sine, Hi Frq Sine mode, FLAT.
2. The following process takes you through all TARGETs in *table 10.6.2.2*. The process sequentially calibrates all amplitudes at one frequency before repeating the same amplitude calibration points at the next frequency step.
3. **9500B:** Set Output ON.
4. **Power Meter:** Select a range that gives an on-scale reading.
5. Adjust the 9500B's output amplitude to give a reading equal to Target Amplitude on the measuring device. The conversion from power to pk-pk voltage is  $\text{pk-pk Voltage} = \sqrt{(\text{power}) * 20}$ .
6. Press **ACCEPT CALIB**.
7. Select the next TARGET and return to step 4; repeat until no TARGETs remain.
8. Press **NEXT FREQ** then select TARGET 1 and return to step 4; repeat until no TARGETs remain.

Final Width = 215mm

**Table 10.6.2.1: Levelled Sine Function: HF Linearity**

Cal. Point	Voltage	Frequency
Target 1	1.0000V	250MHz
Target 2	1.5000V	250MHz
Target 3	2.0000V	250MHz
Target 4	3.0000V	250MHz
Target 5	5.5000V	250MHz

**Table 10.6.2.2: Levelled Sine Function: HF Flatness**

Cal. Point	Voltage	Frequency
Target 1	3.0000V	50kHz
Target 2	1.0072V	50kHz
Target 3	316.49mV	50kHz
Target 4	316.49mV	50kHz

Repeat the process using the Cal. Point voltage levels in the Targets 1 - 4 sequence for each of these frequency points, for a total of 28 calibration steps:

Targets 05 - 08: 10MHz	Targets 17 - 20: 550MHz
Targets 09 - 12: 50MHz	Targets 21 - 24: 800MHz
Targets 13 - 16: 250MHz	Targets 25 - 28: 1.0GHz

**10.6.2.6 Calibration Procedure: 3GHz Levelled Sine Function: HF Linearity (9530 only)**

1. **9500B:** Ensure that the 9500B is in HEAD CAL, Sine, 3GHz Sine mode, LIN.
2. The following process takes you through all TARGETs in *table 10.6.2.3*.
3. **9500B:** Set Output ON.
4. **Power Meter:** Select a range that gives an on-scale reading.
5. Adjust the 9500B's output amplitude to give a reading equal to Target Amplitude on the measuring device. The conversion from power to pk-pk voltage is  $\text{pk-pk Voltage} = \sqrt{(\text{power}) * 20}$ .
6. Press **ACCEPT CALIB**.
7. Select the next TARGET and return to step 4; repeat until no TARGETs remain.

**10.6.2.7 Calibration Procedure: 3GHz Levelled Sine Function: HF Flatness (9530 only)**

1. **9500B:** Ensure that the 9500B is in HEAD CAL, Sine, 3GHz Sine mode, FLAT.
2. The following process takes you through all TARGETs in *table 10.6.2.4*. The process sequentially calibrates all amplitudes at one frequency before repeating the same amplitude calibration points at the next frequency step.
3. **9500B:** Set Output ON.
4. **Power Meter:** Select a range that gives an on-scale reading.
5. Adjust the 9500B's output amplitude to give a reading equal to Target Amplitude on the measuring device. The conversion from power to pk-pk voltage is  $\text{pk-pk Voltage} = \sqrt{(\text{power}) * 20}$ .
6. Press **ACCEPT CALIB**.
7. Select the next TARGET and return to step 4; repeat until no TARGETs remain.
8. Press **NEXT FREQ** then select TARGET 1 and return to step 4; repeat until no TARGETs remain.

**Table 10.6.2.3: 3GHz Levelled Sine Function: HF Linearity**

Cal. Point	Voltage	Frequency
Target 1	450.00mV	1.2GHz
Target 2	800.00mV	1.2GHz
Target 3	1.2000V	1.2GHz
Target 4	2.0000V	1.2GHz
Target 5	2.8000V	1.2GHz
Target 6	3.7000V	1.2GHz

**Table 10.6.2.4: 3GHz Levelled Sine Function: HF Flatness**

Cal. Point	Voltage	Frequency
Target 1	2.0000V	1.2GHz
Target 2	671.48mV	1.2GHz
Target 3	210.99mV	1.2GHz
Target 4	70.839mV	1.2GHz
Target 5	22.259mV	1.2GHz

Final Width = 215mm

Repeat the process using the Cal. Point voltage levels in the Targets 1 - 5 sequence for each of these frequency points, for a total of 75 calibration steps:

Targets 06 - 10: 1.50GHz	Targets 41 - 45: 2.55GHz
Targets 11 - 15: 1.75GHz	Targets 46 - 50: 2.65GHz
Targets 16 - 20: 1.95GHz	Targets 51 - 55: 2.80GHz
Targets 21 - 25: 2.05GHz	Targets 56 - 60: 2.95GHz
Targets 26 - 30: 2.20GHz	Targets 61 - 65: 3.00GHz
Targets 31 - 35: 2.30GHz	Targets 66 - 70: 3.10GHz
Targets 36 - 40: 2.45GHz	Targets 71 - 75: 3.20GHz

**10.6.2.8 Calibration Procedure: 6GHz Levelled Sine  
Function: HF Linearity (9560 only)**

- 9500B:** Ensure that the 9500B is in HEAD CAL, Sine, 6GHz Sine mode, LIN.
- The following process takes you through all TARGETs in *table 10.6.2.3*.
- 9500B:** Set Output ON.
- Power Meter:** Select a range that gives an on-scale reading.
- Adjust the 9500B's output amplitude to give a reading equal to Target Amplitude on the measuring device. The conversion from power to pk-pk voltage is  $\text{pk-pk Voltage} = \sqrt{(\text{power}) * 20}$ .
- Press **ACCEPT CALIB**.
- Select the next TARGET and return to step 4; repeat until no TARGETs remain.
- Adjust the 9500B's output amplitude to give a reading equal to Target Amplitude on the measuring device. The conversion from power to pk-pk voltage is  $\text{pk-pk Voltage} = \sqrt{(\text{power}) * 20}$ .
- Press **ACCEPT CALIB**.
- Select the next TARGET and return to step 4; repeat until no TARGETs remain.

**Table 10.6.2.3: 6GHz Levelled Sine Function:  
HF Linearity**

Cal. Point	Voltage	Frequency
Target 1	450.00mV	1.2GHZ
Target 2	700.00mV	1.2GHZ
Target 3	1.0000V	1.2GHZ
Target 4	1.6000V	1.2GHZ
Target 5	2.4000V	1.2GHZ
Target 6	3.5000V	1.2GHZ
Target 7	400.00mV	3.3GHZ
Target 8	700.00mV	3.3GHZ
Target 9	1.0000V	3.3GHZ
Target 10	1.6000V	3.3GHZ
Target 11	2.0000V	3.3GHZ
Target 12	2.5000V	3.3GHZ

Final Width = 215mm

**10.6.2.9 Calibration Procedure: 6GHz Levelled Sine  
Function: HF Flatness (9560 only)**

- 9500B:** Ensure that the 9500B is in HEAD CAL, Sine, 6GHz Sine mode, FLAT.
- The following process takes you through all TARGETs in *table 10.6.2.4*. The process sequentially calibrates all amplitudes at one frequency before repeating the same amplitude calibration points at the next frequency step.
- 9500B:** Set Output ON.
- Power Meter:** Select a range that gives an on-scale reading.
- Adjust the 9500B's output amplitude to give a reading equal to Target Amplitude on the measuring device. The conversion from power to pk-pk voltage is  $\text{pk-pk Voltage} = \sqrt{(\text{power}) * 20}$ .
- Press **ACCEPT CALIB**.
- Select the next TARGET and return to step 4; repeat until no TARGETs remain.
- Press **NEXT FREQ** then select TARGET 1 and return to step 4; repeat until no TARGETs remain.

**Table 10.6.2.4: 6GHz Levelled Sine Function:  
HF Flatness**

Cal. Point	Voltage ( $\leq 3.2\text{GHz}$ )	Voltage ( $> 3.2\text{GHz}$ )	Freq.
Target 1	2.0000V	1.6000V	1.2GHZ
Target 2	671.48mV	526.30mV	1.2GHZ
Target 3	210.99mV	155.30mV	1.2GHZ
Target 4	70.839mV	51.300mV	1.2GHZ
Target 5	22.259mV	15.240mV	1.2GHZ

Repeat the process using the Cal. Point voltage levels in the Targets 1 - 5 sequence for each of these frequency points, for a total of 136 calibration steps:

Targets 06 - 10: 1.50GHZ	Targets 80 - 83: 3.50GHZ
Targets 11 - 15: 1.75GHZ	Targets 84 - 87: 3.70GHZ
Targets 16 - 20: 1.95GHZ	Targets 88 - 91: 3.90GHZ
Targets 21 - 25: 2.05GHZ	Targets 92 - 95: 4.10GHZ
Targets 26 - 30: 2.20GHZ	Targets 96 - 99: 4.30GHZ
Targets 31 - 35: 2.30GHZ	Targets 100 - 103: 4.50GHZ
Targets 36 - 40: 2.45GHZ	Targets 104 - 107: 4.70GHZ
Targets 41 - 45: 2.55GHZ	Targets 108 - 111: 5.00GHZ
Targets 46 - 50: 2.65GHZ	Targets 112 - 115: 5.30GHZ
Targets 51 - 55: 2.80GHZ	Targets 116 - 119: 5.50GHZ
Targets 56 - 60: 2.90GHZ	Targets 120 - 123: 5.80GHZ
Targets 61 - 65: 3.00GHZ	Targets 124 - 127: 6.00GHZ
Targets 66 - 70: 3.10GHZ	Targets 128 - 131: 6.20GHZ
Targets 71 - 75: 3.20GHZ	Targets 132 - 136: 6.40GHZ
Targets 76 - 79: 3.30GHZ	

## 10.6.3 Calibrating the Edge Function

### 10.6.3.1 Summary

The Edge Function is calibrated by applying risetime corrections in the sequences given in *paras 10.6.3.4 through 10.6.3.9*.

Equipment requirements are given in *para 10.6.6.2*; *para 10.6.6.3* describes the Calibration Setup.

### 10.6.3.2 Equipment Requirements

- The UUT Active Head, connected to a verified Model 9500B Mainframe.
- High-bandwidth sampling oscilloscope with bandwidth  $\geq 6\text{GHz}$  for Risetime measurements. ( $\geq 20\text{GHz}$  for 9550 and 9560)  
Example: *Tektronix Model TDS820 or HP 54750*.
- $50\Omega$  SMA - SMA co-axial 'Trigger' cable for trigger inputs to the high-bandwidth oscilloscope.
- High-bandwidth coaxial attenuator may be required if 9500B edge output voltage exceeds oscilloscope input capability.  
Example: *HP8493 Copt20 26.5GHz 3.5mm 20dB attenuator*.
- $50\Omega$  SMA - BNC adaptor  
Example: *Suhner 33 SMA-BNC-50-1*

### 10.6.3.3 Calibration Setup

- 1. Connections** Ensure that the 9500B is connected to the Oscilloscope as shown in *Fig. 10.6.3.1*, and that both instruments are powered on and warmed up.
- 2. Oscilloscope** Select the required function to measure edge response.  
Caution: The 9500B Edge function output is capable of generating voltages that may cause damage to sampling oscilloscope inputs with limited input voltage capability. Use of an attenuator is typically required for outputs above 1V pk-pk.

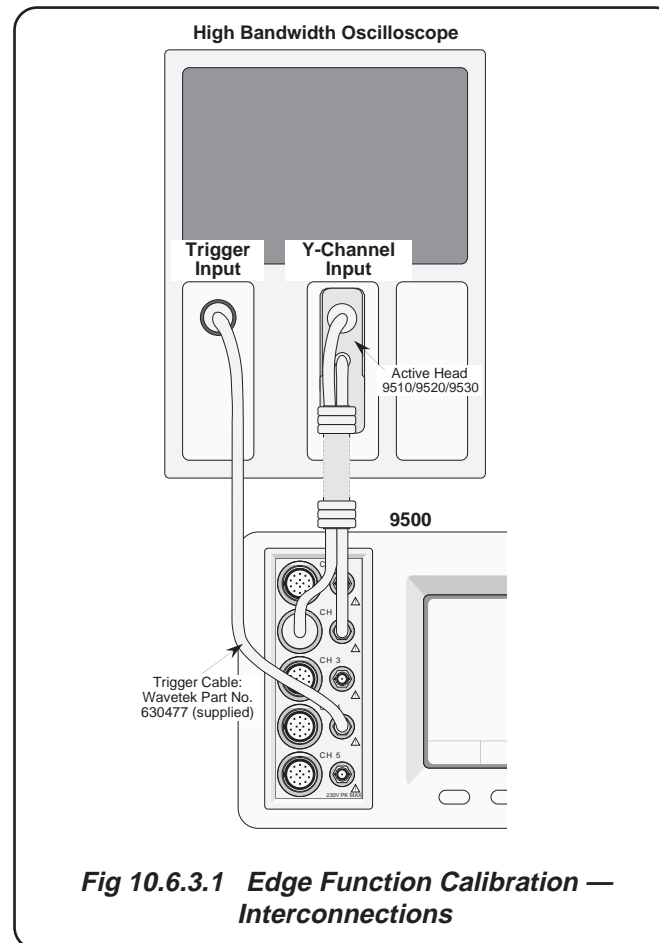

*Final Width = 215mm*

#### 10.6.3.4 Calibration Procedure: 500ps Edge: Linearity

1. Ensure that the 9500B is connected to the oscilloscope as shown in *figure 10.6.3.1.* and that both instruments are powered on and warmed up.
2. Select the required 9500B Trigger Channel, Cable Select and Trigger Ratio settings.
3. Select the required measurement device function to measure edge response.
4. Ensure that the 9500B is in HEAD CAL, Edge, 500ps Edge, LIN mode.
5. Set the 9500B's output ON.
6. Select a measurement device range that gives an on-scale reading.
7. Adjust the 9500B's output amplitude to give a measurement device reading equal to TARGET 1 amplitude in *table 10.6.3.1.*
8. Press **ACCEPT CALIB.**
9. Select the next TARGET in *table 10.6.3.1* and return to step 4; repeat until no TARGETs remain.

**Table 10.6.3.1: Edge Function: 500ps Edge: Linearity**

Cal. Point	Voltage	Frequency	Edge
Target 1	1.0000V	100kHz	Rising
Target 2	2.0000V	100kHz	Rising
Target 3	2.5000V	100kHz	Rising
Target 4	1.0000V	100kHz	Falling
Target 5	2.0000V	100kHz	Falling
Target 6	2.5000V	100kHz	Falling

#### 10.6.3.5 Calibration Procedure: 500ps Edge: Gain

1. Ensure that the 9500B is connected to the oscilloscope as shown in *figure 10.6.3.1.* and that both instruments are powered on and warmed up.
2. Select the required 9500B Trigger Channel, Cable Select and Trigger Ratio settings.
3. Select the required measurement device function to measure edge response.
4. Ensure that the 9500B is in HEAD CAL, Edge, 500ps Edge, GAIN mode.
5. Set the 9500B's output ON.
6. Select a measurement device range that gives an on-scale reading.
7. Adjust the 9500B's output amplitude to give a measurement device reading equal to TARGET 1 amplitude in *table 10.6.3.2.*
8. Press **ACCEPT CALIB.**

**Table 10.6.3.2: Edge Function: 500ps Edge: Gain**

Cal. Point	Voltage	Frequency	Edge
Target 1	2.5000V	100kHz	Rising

Final Width = 215mm

### 10.6.3.6 Calibration Procedure: 500ps Edge: Speed

1. Ensure that the 9500B is connected to the oscilloscope as shown in *figure 10.6.3.1*, and that both instruments are powered on and warmed up.
2. Select the required 9500B Trigger Channel, Cable Select, and Trigger Ratio settings.
3. Select the required measurement device function to measure edge response.
4. Ensure that the 9500B is in HEAD CAL, Edge, 500ps Edge, SPEED mode.
5. Set 9500B's output ON, selecting TARGET 1 from *table 10.6.3.3*.
6. Select a measurement device range that gives an on-scale reading.
7. Note the rise or fall time of the edge and enter it into the Edge Speed field on the 9500B. Make sure allowance is made for the rise time of the oscilloscope:  
Edge Rise Time =  $\sqrt{(\text{Measured Rise Time})^2 - (\text{Scope Rise Time})^2}$ .
8. Press **ACCEPT CALIB**.
9. Select the next TARGET in *table 10.6.3.3* by pressing **NEXT TARGET** and return to step 4; repeat until no TARGETs remain.

**Table 10.6.3.3: Edge Function: 500ps Edge: Speed**

Cal. Point	Voltage	Frequency	Edge
Target 1	3.0000V	1MHz	Rising
Target 2	2.0000V	1MHz	Rising
Target 3	1.0000V	1MHz	Rising
Target 4	1.0072V	1MHz	Rising
Target 5	316.49mV	1MHz	Rising
Target 6	316.49mV	1MHz	Rising
Target 7	3.0000V	1MHz	Falling
Target 8	20000V	1MHz	Falling
Target 9	1.0000V	1MHz	Falling
Target 10	1.0072V	1MHz	Falling
Target 11	316.49mV	1MHz	Falling
Target 12	316.49mV	1MHz	Falling

### 10.6.3.7 Calibration Procedure: 150ps Edge: Linearity

1. Ensure that the 9500B is connected to the oscilloscope as shown in *figure 10.6.3.1*, and that both instruments are powered on and warmed up.
2. Select the required 9500B Trigger Channel, Cable Select, and Trigger Ratio settings.
3. Select the required measurement device function to measure edge response.
4. Ensure that the 9500B is in HEAD CAL, Edge, 150ps Edge, LIN mode.
5. Set 9500B's output ON, selecting TARGET 1 from *table 10.6.3.4*.
6. Select a measurement device range that gives an on-scale reading.
7. Adjust the 9500B's output amplitude to give a reading equal to Target Amplitude on the oscilloscope.
8. Press **ACCEPT CALIB**.
9. Select the next TARGET in *table 10.6.3.4* by pressing **NEXT TARGET** and return to step 4; repeat until no TARGETs remain.

**Table 10.6.3.4: Edge Function: 150ps Edge: Linearity**

Cal. Point	Voltage	Frequency	Edge
Target 1	1.0000V	100kHz	Rising
Target 2	2.0000V	100kHz	Rising
Target 3	2.5000V	100kHz	Rising
Target 4	1.0000V	100kHz	Falling
Target 5	2.0000V	100kHz	Falling
Target 6	2.5000V	100kHz	Falling

Final Width = 215mm

### 10.6.3.8 Calibration Procedure: 150ps Edge: Gain

1. Ensure that the 9500B is connected to the oscilloscope as shown in *figure 10.6.3.1*, and that both instruments are powered on and warmed up.
2. Select the required 9500B Trigger Channel, Cable Select, and Trigger Ratio settings.
3. Select the required measurement device function to measure edge response.
4. Ensure that the 9500B is in HEAD CAL, Edge, 150ps Edge, GAIN mode.
5. Set 9500B's output ON, selecting TARGET 1 from *table 10.6.3.5*.
6. Select a measurement device range that gives an on-scale reading.
7. Adjust the 9500B's output amplitude to give a reading equal to Target Amplitude on the oscilloscope.
8. Press **ACCEPT CALIB**.
9. Select the next TARGET in *table 10.6.3.5* by pressing **NEXT TARGET** and return to step 4; repeat until no TARGETs remain.

### 10.6.3.9 Calibration Procedure: 150ps Edge: Speed

1. Ensure that the 9500B is connected to the oscilloscope as shown in *figure 10.6.3.1*, and that both instruments are powered on and warmed up.
2. Select the required 9500B Trigger Channel, Cable Select, and Trigger Ratio settings.
3. Select the required measurement device function to measure edge response.
4. Ensure that the 9500B is in HEAD CAL, Edge, 150ps Edge, SPEED mode.
5. Set 9500B's output ON, selecting TARGET 1 from *table 10.6.3.6*.
6. Select a measurement device range that gives an on-scale reading.
7. Note the rise or fall time of the edge and enter it into the Edge Speed Field on the 9500B. Make sure allowance is made for the rise time of the oscilloscope:  
Edge Rise Time =  $\sqrt{(\text{Measured Rise Time})^2 - (\text{Scope Rise Time})^2}$ .
8. Press **ACCEPT CALIB**.
9. Select the next TARGET in *table 10.6.3.6* by pressing **NEXT TARGET** and return to step 4; repeat until no TARGETs remain.

Final Width = 215mm

**Table 10.6.3.5 LS Function: 150ps Edge: Gain**

Cal. Point	Voltage	Frequency	Edge
Target 1	2.5000V	100kHz	Rising
Target 2	839.39mV	100kHz	Rising
Target 3	263.74mV	100kHz	Rising
Target 4	263.74mV	100kHz	Rising

**Table 10.6.3.6: Edge Function: 150ps Edge: Speed**

Cal. Point	Voltage	Frequency	Edge
Target 1	3.0000V	1MHz	Rising
Target 2	2.0000V	1MHz	Rising
Target 3	1.0000V	1MHz	Rising
Target 4	1.0072V	1MHz	Rising
Target 5	316.49mV	1MHz	Rising
Target 6	316.49mV	1MHz	Rising
Target 7	3.0000V	1MHz	Falling
Target 8	2.0000V	1MHz	Falling
Target 9	1.0000V	1MHz	Falling
Target 10	1.0072V	1MHz	Falling
Target 11	316.49mV	1MHz	Falling
Target 12	316.49mV	1MHz	Falling



### 10.6.3.10 Calibration Procedure: 70ps Edge: Linearity

1. Ensure that the 9500B is connected to the oscilloscope as shown in *figure 10.6.3.1*, and that both instruments are powered on and warmed up.
2. Select the required 9500B Trigger Channel, Cable Select, and Trigger Ratio settings.
3. Select the required measurement device function to measure edge response.
4. Ensure that the 9500B is in HEAD CAL, Edge, 70ps Edge, LIN mode.
5. Set 9500B's output ON, selecting TARGET 1 from *table 10.6.3.4*.
6. Select a measurement device range that gives an on-scale reading.
7. Adjust the 9500B's output amplitude to give a reading equal to Target Amplitude on the oscilloscope.
8. Press **ACCEPT CALIB**.
9. Select the next TARGET in *table 10.6.3.4* by pressing **NEXT TARGET** and return to step 4; repeat until no TARGETs remain.

**Table 10.6.3.7: Edge Function: 70ps Edge: Linearity**

Cal. Point	Voltage	Frequency	Edge
Target 1	25mV	100kHz	Rising
Target 2	40mV	100kHz	Rising
Target 3	70mV	100kHz	Rising
Target 4	75mV	100kHz	Rising
Target 5	120mV	100kHz	Rising
Target 6	220mV	100kHz	Rising
Target 7	250mV	100kHz	Rising
Target 8	400mV	100kHz	Rising
Target 9	700mV	100kHz	Rising
Target 10	750mV	100kHz	Rising
Target 11	1.2V	100kHz	Rising
Target 12	2.2V	100kHz	Rising

### 10.6.3.11 Calibration Procedure: 70ps Edge: Speed

1. Ensure that the 9500B is connected to the oscilloscope as shown in *figure 10.6.3.1*, and that both instruments are powered on and warmed up.
2. Select the required 9500B Trigger Channel, Cable Select, and Trigger Ratio settings.
3. Select the required measurement device function to measure edge response.
4. Ensure that the 9500B is in HEAD CAL, Edge, 150ps Edge, SPEED mode.
5. Set 9500B's output ON, selecting TARGET 1 from *table 10.6.3.6*.
6. Select a measurement device range that gives an on-scale reading.
7. Note the rise or fall time of the edge and enter it into the Edge Speed Field on the 9500B. Make sure allowance is made for the rise time of the oscilloscope:  
Edge Rise Time =  $\sqrt{(\text{Measured Rise Time})^2 - (\text{Scope Rise Time})^2}$ .
8. Press **ACCEPT CALIB**.
9. Select the next TARGET in *table 10.6.3.6* by pressing **NEXT TARGET** and return to step 4; repeat until no TARGETs remain.

**Table 10.6.3.8: Edge Function: 70ps Edge: Speed**

Cal. Point	Voltage	Frequency	Edge
Target 1	2.2000V	1MHz	Rising
Target 2	1.2000V	1MHz	Rising
Target 3	750mV	1MHz	Rising
Target 4	700mV	1MHz	Rising
Target 5	400mV	1MHz	Rising
Target 6	250mV	1MHz	Rising
Target 7	220mV	1MHz	Rising
Target 8	120mV	1MHz	Rising
Target 9	75mV	1MHz	Rising
Target 10	70mV	1MHz	Rising
Target 11	40mV	1MHz	Rising
Target 12	25mV	1MHz	Rising

Final Width = 215mm

---

### 10.6.3.12 Calibration Procedure: 25ps Edge: Speed

1. Ensure that the 9500B is connected to the oscilloscope as shown in *figure 10.6.3.1*, and that both instruments are powered on and warmed up.
2. Select the required 9500B Trigger Channel, Cable Select, and Trigger Ratio settings.
3. Select the required measurement device function to measure edge response.
4. Ensure that the 9500B is in HEAD CAL, Edge, 25ps Edge, SPEED mode.
5. Set 9500B's output ON, selecting TARGET 1 from *table 10.6.3.6*.
6. Select a measurement device range that gives an on-scale reading.
7. Note the rise or fall time of the edge and enter it into the Edge Speed Field on the 9500B. Make sure allowance is made for the rise time of the oscilloscope:  
Edge Rise Time =  $\sqrt{(\text{Measured Rise Time})^2 - (\text{Scope Rise Time})^2}$ .
8. Press **ACCEPT CALIB**.
9. Select the next TARGET in *table 10.6.3.6* by pressing **NEXT TARGET** and return to step 4; repeat until no TARGETs remain.

Final Width = 215mm

**Table 10.6.3.9: Edge Function: 25ps Edge: Speed**

Cal. Point	Voltage	Frequency	Edge
Target 1	500mV	1MHz	Rising
Target 2	500mV	1MHz	Falling

### 10.6.4 Calibrating the Timing Markers (9510 only)

1. Ensure that the 9500B is connected to the Power Meter as shown in *figure 10.6.4.1*, satisfies the equipment requirements in *para 10.6.2.2*, and that both instruments are powered on and warmed up.
2. **9500B:** Ensure that the 9500B is in HEAD CAL, Other, Timing Marker.
3. The following process takes you through TARGETs 1 - 3 in *table 10.6.4.1*, repeating amplitude calibrations for frequency points in TARGETs 4 - 9.
4. **9500B:** Set Output ON.
5. **Power Meter:** Select a range that gives an on-scale reading.
6. Adjust the 9500B's output amplitude to give a reading equal to Target Amplitude on the measuring device. The conversion from power to pk-pk voltage is  $\text{pk-pk Voltage} = \sqrt{(\text{power}) * 20}$ .
7. Press **ACCEPT CALIB.**
8. Select the next TARGET and return to step 4; repeat until no TARGETs remain.
9. Press **NEXT FREQ** then select TARGET 1 and return to step 4; repeat until no TARGETs remain.

**Table 10.6.4.1: Timing Marker Calibration Points**

Cal. Point	Voltage	Frequency
Target 1	100.00mV	1.11GHz
Target 2	250.00mV	1.11GHz
Target 3	500.00mV	1.11GHz

Repeat the sequence using the Cal. Point voltage levels in TARGETs 1 - 3 for each of these frequency points, for a total of 9 calibration steps:

Targets 4 - 6: 1.6GHz
Targets 7 - 9: 2.0GHz

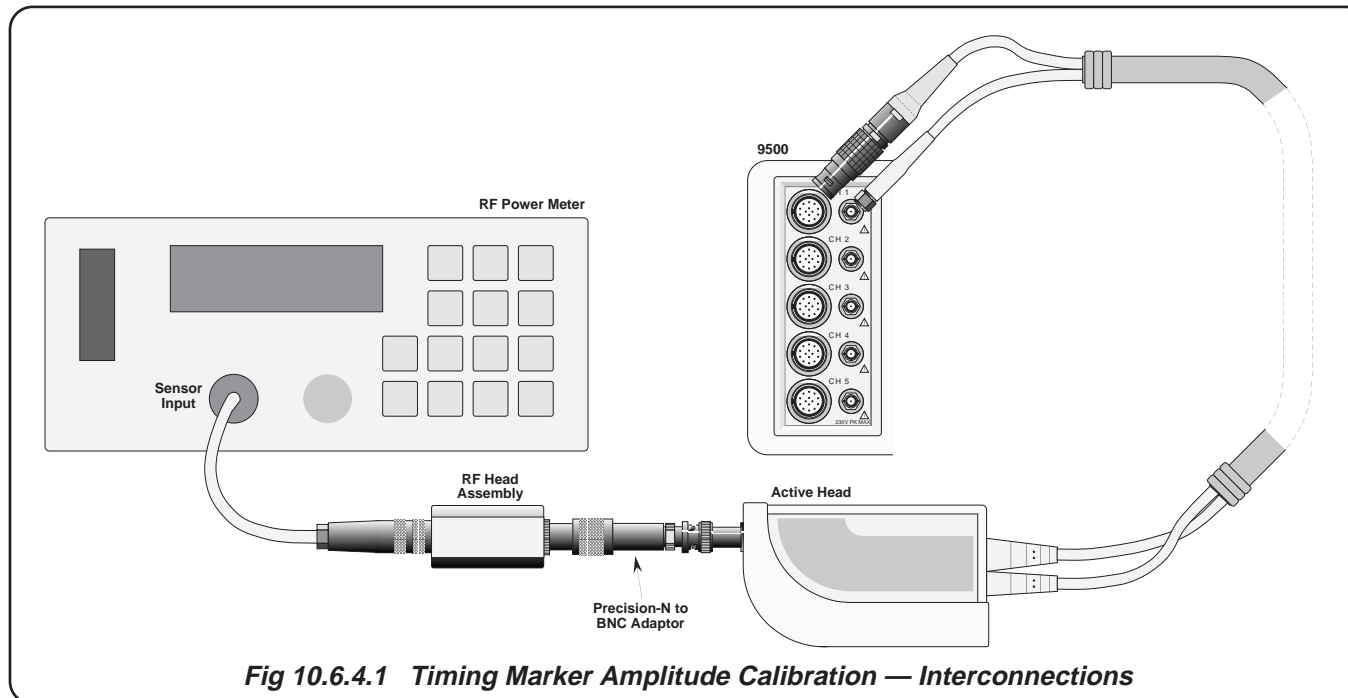

**Fig 10.6.4.1 Timing Marker Amplitude Calibration — Interconnections**

*Final Width = 215mm*

### 10.6.5 Load Capacitance Function Calibration (9510 and 9530 only)

Equipment required - two calibrated capacitance standards:

- i) calibrated value between 15pF and 25pF
- ii) calibrated value between 85pF and 95pF.

These values may be recorded in *table 10.6.5.1* for use during the calibration and for future reference.

1. Make connections as shown in *figure 10.6.5.1*.
2. **9500B:** Ensure that the 9500B is in HEAD CAL, Other, Load Cap.
3. The following process takes you through all TARGETs in *table 10.6.5.1*.
4. **9500B:** Set Output ON.
5. Connect the appropriate standards capacitors with nominal values as shown in *table 10.6.5.1*.

6. Enter the calibrated value of the standard capacitor (recorded in *table 10.6.5.1*) into the 9500B's **Target Cap.** field and press **Enter**.
7. Press **ACCEPT CALIB.**
8. Select the next TARGET and return to step 4; repeat until no TARGETs remain.

**Table 10.6.5.1: Load Capacitor Calibration Points**

Cal. Point	Nominal Cap. Value	Calibrated Cap.Value
Target 1	0 pF	
Target 2	15 pF	
Target 3	82 pF	

Final Width = 215mm

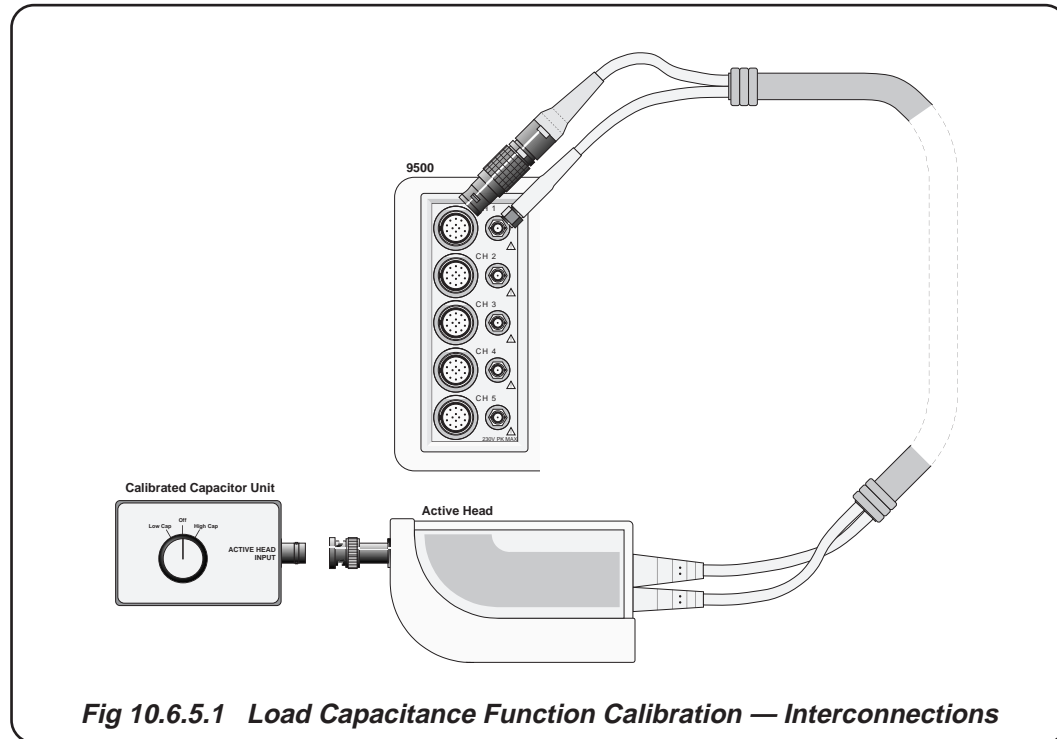

**Fig 10.6.5.1 Load Capacitance Function Calibration — Interconnections**

## 10.6.6 50Ω / 1MΩ Ratio Calibration

- 1 Ensure that the 9500B is connected to the DMM as shown in figure 10.6.6.1, and that both instruments are powered and warmed up.
- 2 **9500B:** It is necessary to temporarily exit the Head Calibration Mode to make and note the result of four measurements. Using the Mode key return the instrument to Manual Mode and select the DC/Square Function.
- 3 **9500B:** Select DC Positive waveform at 5.0000V configured to drive 1MΩ.
- 4 On the **4955** Select “DCV o/c” (or simply connect the Head directly to the DMM). Turn the 9500B Output ON, allow the DMM to settle and note the measurement in Table 10.6.6.1.
- 5 **9500B:** Select DC Positive waveform at 5.0000V configured to drive 50Ω.
- 6 On the **4955** Select “DCV 50Ω” (or use an alternative shunt resistor). Turn the 9500B Output ON, allow the DMM to settle and note the measurement in Table 10.6.6.1.
- 7 **9500B:** Select Square waveform with positive bias at 5.0000V pk-pk configured to drive 1MΩ.
- 8 On the **4955** Select “SQR o/c” (or connect the Head directly to the DMM, configured to measure DC voltage). Turn the 9500B Output ON, allow the DMM to settle and note the measurement in Table 10.6.6.1. Please note that the DMM reading (average DC level) should be multiplied by two (pk-pk level).
- 9 **9500B:** Select Square waveform with positive bias at 5.0000V pk-pk configured to drive 50Ω.
- 10 On the **4955** Select “SQR 50Ω” (or use an alternative shunt resistor). Turn the 9500B Output ON, allow the DMM to settle and note the measurement in Table 10.6.6.1. Please note that the DMM reading (average DC level) should be multiplied by two (pk-pk level). Having made the necessary measurements, re-enter the Head Calibration mode using the Mode and Cal keys.
- 11 **9500B:** Select HEAD CAL, Other, 50Ω/1MΩ Ratio. For Target 1, this screen requires entry of two Measurement values for the DC function - Target 1.1 and Target 1.2. Repeat this process for Target 2 and the values Target 2.1 and 2.2.

Table overleaf→

Final Width = 215mm

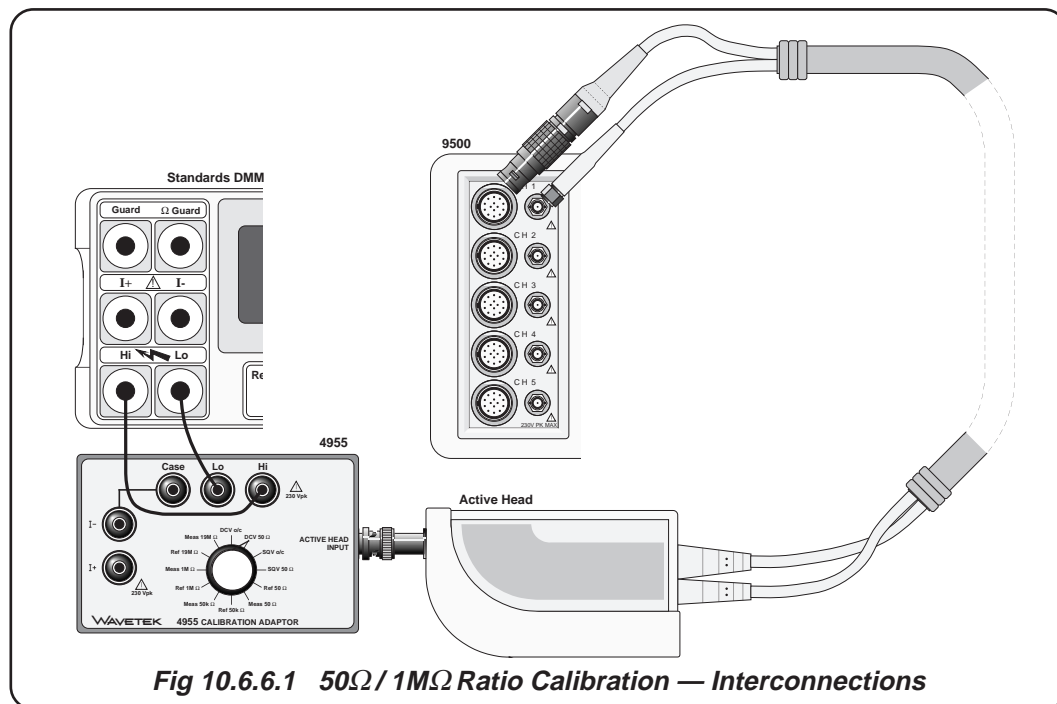

Fig 10.6.6.1 50Ω / 1MΩ Ratio Calibration — Interconnections

---

## 10.6.6 50Ω / 1MΩ Ratio Calibration (cont)

**Table 10.6.6.1: 50Ω / 1MΩ Ratio Calibration Points**

Meas. Point	Target Voltage	Waveshape	DC Voltage Measurement	Target Name
Target1.1	5.0000V	DC		Amp @ 1MΩ
Target 1.2	5.0000V	DC		Amp @ 50Ω
Target 2.1	5.0000Vpk-pk	Square		Amp @ 1MΩ
Target 2.2	5.0000Vpk-pk	Square		Amp @ 50Ω

*Final Width = 215mm*

---

## 10.6.7 Exit from Head Calibration

When the necessary calibration operations are complete, return to the Calibration screen that contains the Exit and Store Head Cal softkeys. Selecting Exit produces the reminder message:

WARNING: Cal data not stored:  
Exit again to abandon data

Select Exit to abandon head cal data.

To store head cal data, select the Store Head Cal softkey, which produces a new screen labelled:

Head Calibration: CH $x$  (where  $x$  is the head number)

Follow the on-screen instructions to:

- select the warning period before recalibration is due
- modify the cal due date

Below the displayed dates is a message that reads:

These heads have unsaved data

followed by a line that identifies the heads e.g. CH1, CH4. If there is no cal data to store, or if all head cal data storage is complete, the NONE indicator appears.

Selecting the Store softkey displays the message:

Saving cal factors to head  $x$  (where  $x$  is the head number)

The save operation may take up to 30 seconds to complete. To save any remaining unsaved head data, use the Channel Select softkey to change to the appropriate head, then select Store. Repeat for each unsaved head until the NONE indicator is displayed.

Select Exit to step back through the menus to the required instrument setting.

---

*Final Width = 215mm*

---

## Fluke's Regional Sales and Service Offices

### **Fluke Corporation**

P .O. Box 9090  
Everett, WA 98206-9090  
U.S.A.

### **Fluke Precision Measurement Ltd**

Hurricane Way  
Norwich  
NR6 6JB  
U.K.

### **Fluke Europe B. V.**

P .O. Box 1186  
5602 BD Eindhoven  
The Netherlands

*Final Width = 215mm*

INSIDE REAR COVER



REAR COVER (LEFT-HAND)